



## Digital Transistors (Built-in Resistors)

### DTC143ZM/DTC143ZE/DTC143ZUA DTC143ZKA /DTC143ZCA/DTC143ZSA

DIGITAL TRANSISTOR (NPN)



#### FEATURES

- Built-in bias resistors enable the configuration of an inverter circuit without connecting external input resistors(see equivalent circuit)
- The bias resistors consist of thin-film resistors with complete isolation to allow negative biasing of the input.They also have the advantage of almost completely eliminating parasitic effects
- Only the on/off conditions need to be set for operation, making device design easy

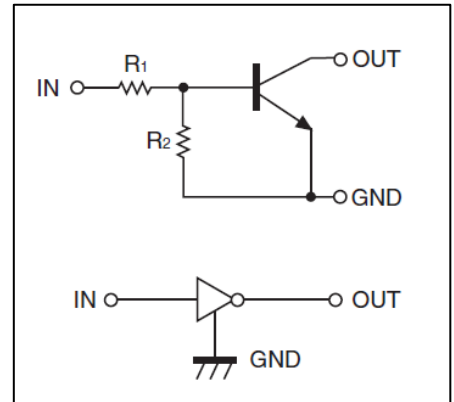
#### • Equivalent Circuit

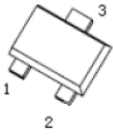
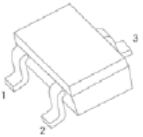
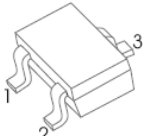
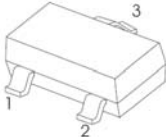
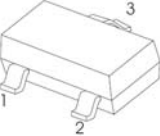

#### PIN CONNENCTIONS and MARKING

<p><b>DTC143ZM</b></p>  <p><b>SOT-723</b></p> <p>1. IN 2. GND 3. OUT</p> <p><b>MARKING: E23</b></p>	<p><b>DTC143ZE</b></p>  <p><b>SOT-523</b></p> <p>1. IN 2. GND 3. OUT</p> <p><b>MARKING: E23</b></p>
<p><b>DTC143ZUA</b></p>  <p><b>SOT-323</b></p> <p>1. IN 2. GND 3. OUT</p> <p><b>MARKING: E23</b></p>	<p><b>DTC143ZKA</b></p>  <p><b>SOT-23-3L</b></p> <p>1. IN 2. GND 3. OUT</p> <p><b>MARKING: E23</b></p>
<p><b>DTC143ZCA</b></p>  <p><b>SOT-23</b></p> <p>1. IN 2. GND 3. OUT</p> <p><b>MARKING: E23</b></p>	<p><b>DTC143ZSA</b></p>  <p><b>TO-92S</b></p> <p>1. GND 2. OUT 3. IN</p>

**MAXIMUM RATINGS(Ta=25°C unless otherwise noted)**

Symbol	Parameter	Limits(DTC143Z□)						Unit
		M	E	UA	CA	KA	SA	
V <sub>CC</sub>	Supply Voltage	50						V
V <sub>IN</sub>	Input Voltage	-5~+30						V
I <sub>O</sub>	Output Current	100						mA
P <sub>D</sub>	Power Dissipation	100	150	200	200	200	300	mW
T <sub>J</sub>	Junction Temperature	150						°C
T <sub>stg</sub>	Storage Temperature	-55~+150						°C

**ELECTRICAL CHARACTERISTICS (Ta=25°C unless otherwise specified)**

Parameter	Symbol	Conditions	Min	Typ	Max	Unit
Input voltage	V <sub>I(off)</sub>	V <sub>CC</sub> =5V, I <sub>O</sub> =100μA	0.5			V
	V <sub>I(on)</sub>	V <sub>O</sub> =0.3V, I <sub>O</sub> =5mA			1.3	V
Output voltage	V <sub>O(on)</sub>	I <sub>O</sub> /I <sub>I</sub> =5mA/0.25mA		0.1	0.3	V
Input current	I <sub>I</sub>	V <sub>I</sub> =5V			1.8	mA
Output current	I <sub>O(off)</sub>	V <sub>CC</sub> =50V, V <sub>I</sub> =0			0.5	μA
DC current gain	G <sub>I</sub>	V <sub>O</sub> =5V, I <sub>O</sub> =10mA	80			
Input resistance	R <sub>1</sub>		3.29	4.7	6.11	kΩ
Resistance ratio	R <sub>2</sub> /R <sub>1</sub>		8	10	12	
Transition frequency	f <sub>T</sub>	V <sub>O</sub> =10V, I <sub>O</sub> =5mA, f=100MHz		250		MHz

# Typical Characteristics

# DTC143ZXX

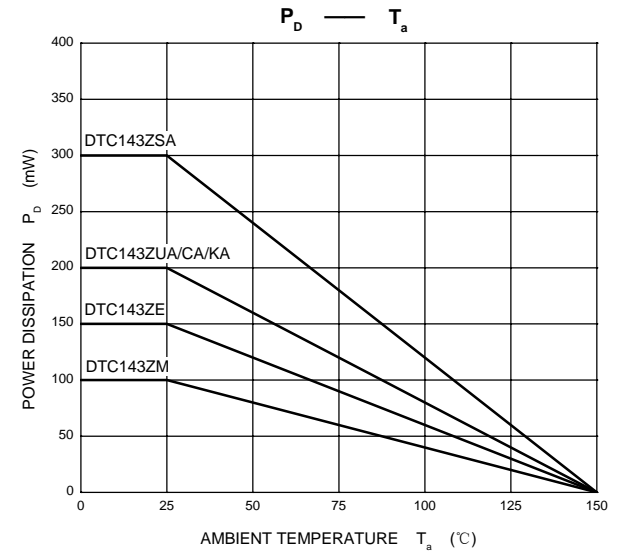
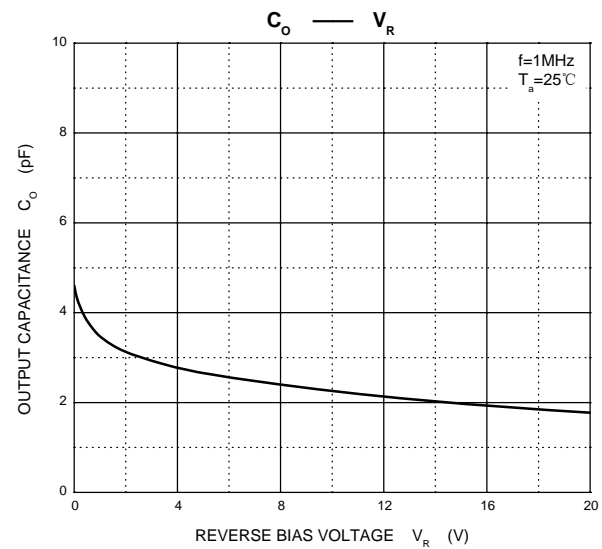
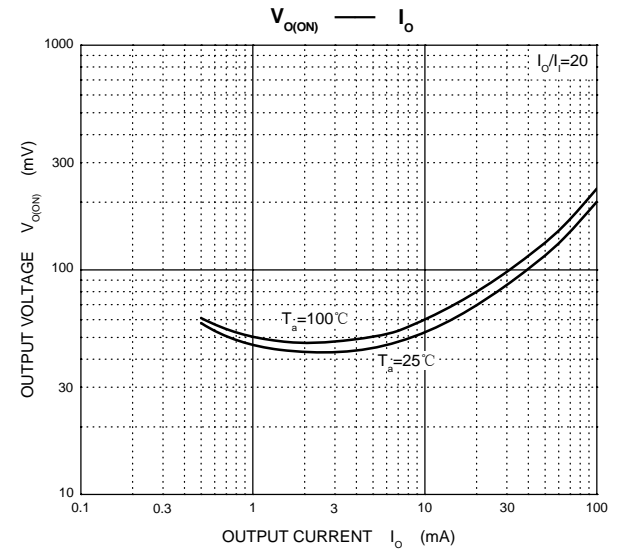
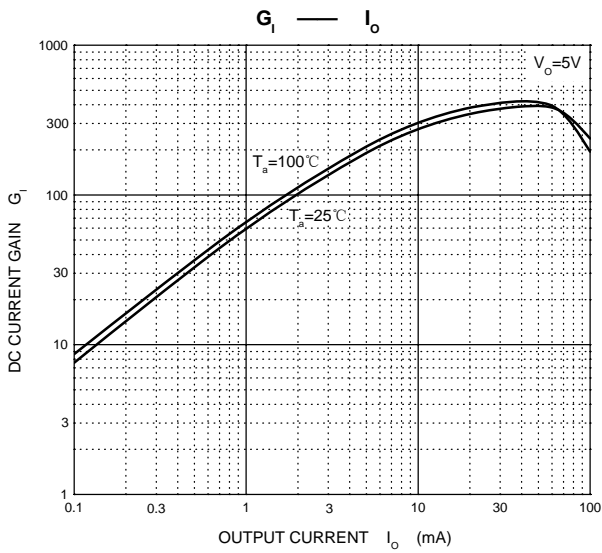
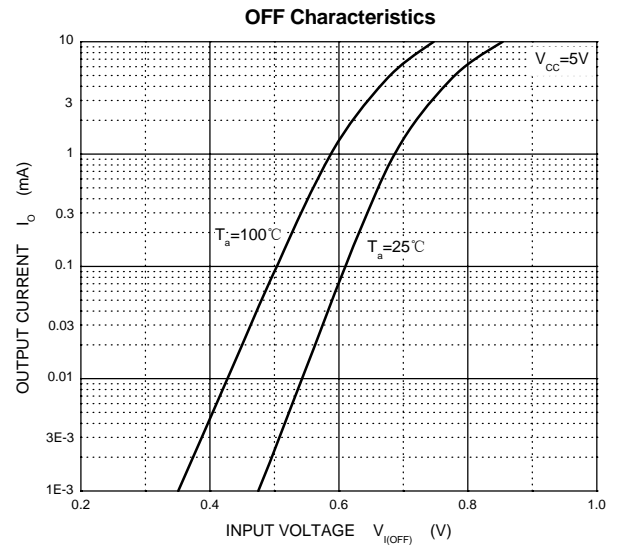
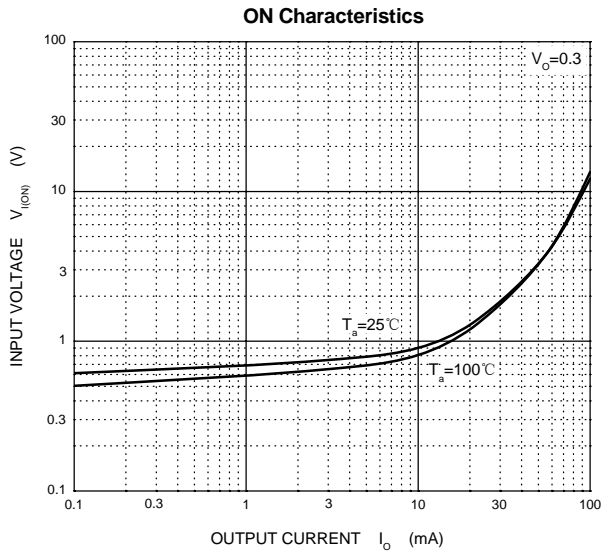

单击下面可查看定价，库存，交付和生命周期等信息

[>>JSCJ](#)