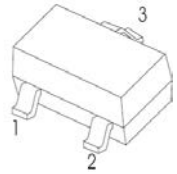

**2SA812** TRANSISTOR (PNP)

**SOT-23**

1. BASE
2. EMITTER
3. COLLECTOR

**FEATURES**

- Complementary to 2SC1623
- High DC Current Gain:  $h_{FE}=200$  TYP. ( $V_{CE}=-6V, I_C=-1mA$ )
- High Voltage:  $V_{ceo}=-50V$

**MAXIMUM RATINGS ( $T_a=25^{\circ}C$  unless otherwise noted)**

Symbol	Parameter	Value	Unit
$V_{CBO}$	Collector-Base Voltage	-60	V
$V_{CEO}$	Collector-Emitter Voltage	-50	V
$V_{EBO}$	Emitter-Base Voltage	-5	V
$I_C$	Collector Current	-100	mA
$P_C$	Collector Power Dissipation	200	mW
$R_{\theta JA}$	Thermal Resistance From Junction To Ambient	625	$^{\circ}C/W$
$T_J, T_{stg}$	Operation Junction and Storage Temperature Range	-55~+150	$^{\circ}C$

**ELECTRICAL CHARACTERISTICS ( $T_a=25^{\circ}C$  unless otherwise specified)**

Parameter	Symbol	Test conditions	Min	Typ	Max	Unit
Collector-base breakdown voltage	$V_{(BR)CBO}$	$I_C=-100\mu A, I_E=0$	-60			V
Collector-emitter breakdown voltage	$V_{(BR)CEO}$	$I_C=-1mA, I_B=0$	-50			V
Emitter-base breakdown voltage	$V_{(BR)EBO}$	$I_E=-100\mu A, I_C=0$	-5			V
Collector cut-off current	$I_{CBO}$	$V_{CB}=-60V, I_E=0$			-0.1	$\mu A$
Emitter cut-off current	$I_{EBO}$	$V_{EB}=-5V, I_C=0$			-0.1	$\mu A$
DC current gain	$h_{FE}$	$V_{CE}=-6V, I_C=-1mA$	90		600	
Collector-emitter saturation voltage	$V_{CE(sat)}$	$I_C=-100mA, I_B=-10mA$			-0.3	V
Base-emitter voltage	$V_{BE}$	$I_C=-1mA, V_{CE}=-6V$	-0.58		-0.68	V
Transition frequency	$f_T$	$V_{CE}=-6V, I_C=-10mA$		180		MHz
Collector output capacitance	$C_{ob}$	$V_{CB}=-10V, I_E=0, f=1MHz$		4.5		pF

**CLASSIFICATION OF  $h_{FE}$** 

Rank	M4	M5	M6	M7
Range	90-180	135-270	200-400	300-600
Marking	M4	M5	M6	M7

# Typical Characteristics

Static Characteristic

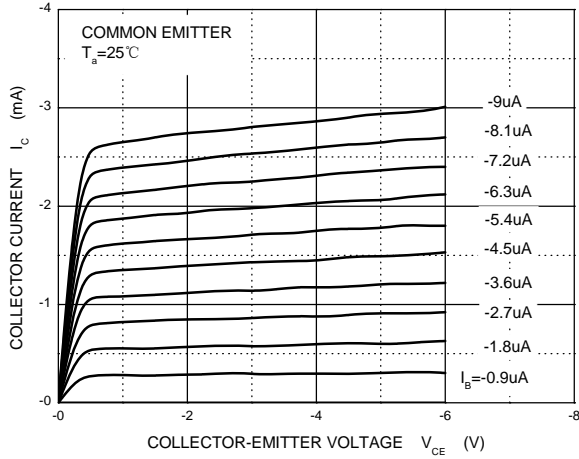

h<sub>FE</sub> — I<sub>c</sub>

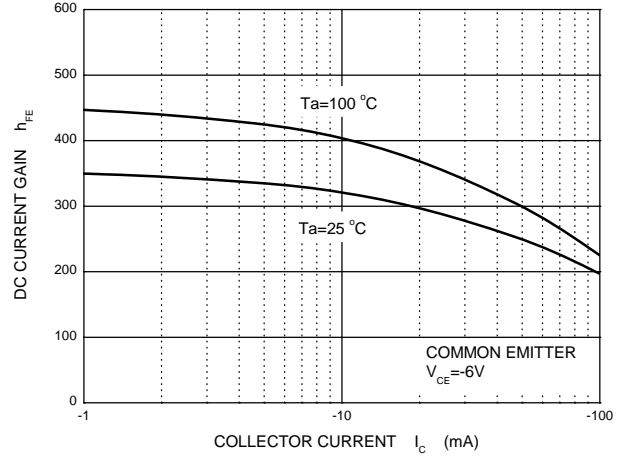

V<sub>CEsat</sub> — I<sub>c</sub>

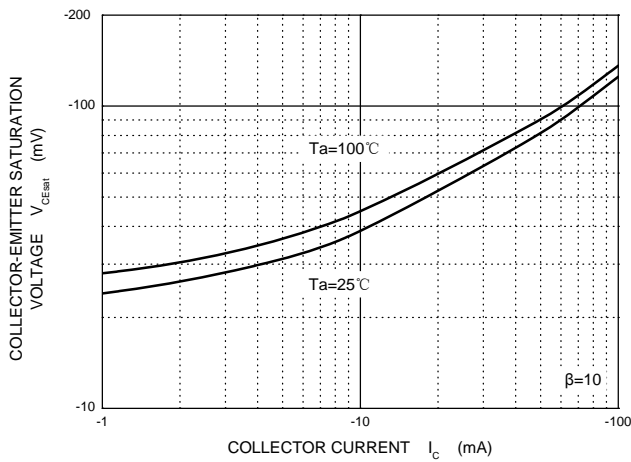

V<sub>BEsat</sub> — I<sub>c</sub>

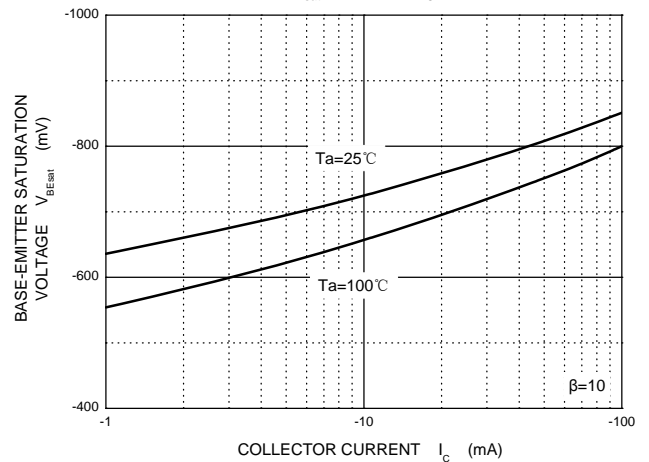

I<sub>c</sub> — V<sub>BE</sub>

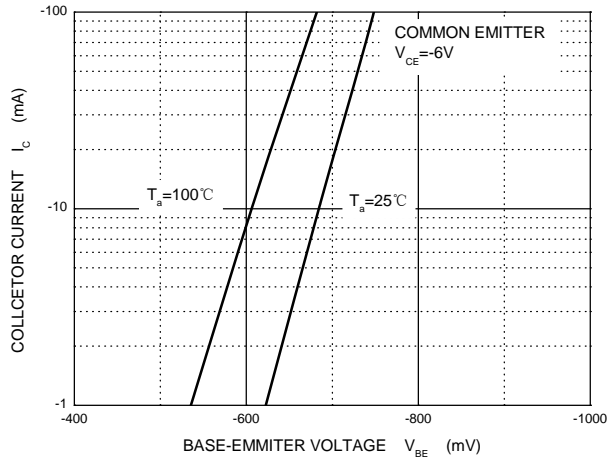

f<sub>T</sub> — I<sub>c</sub>

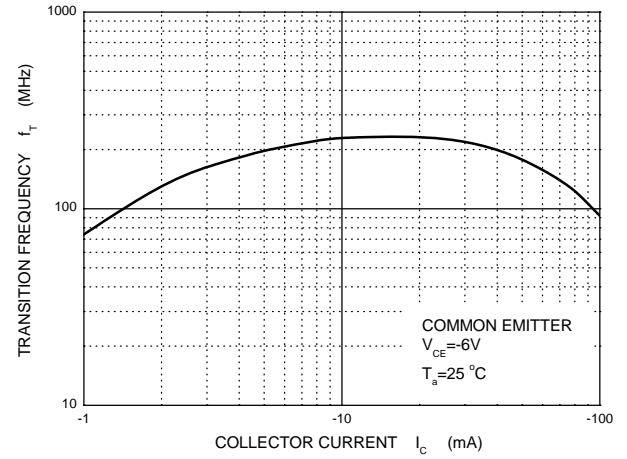

C<sub>ob</sub>/C<sub>ib</sub> — V<sub>CB</sub>/V<sub>EB</sub>

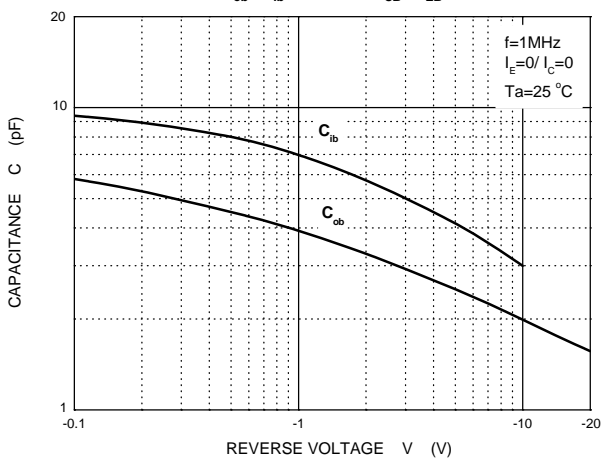

P<sub>c</sub> — T<sub>a</sub>

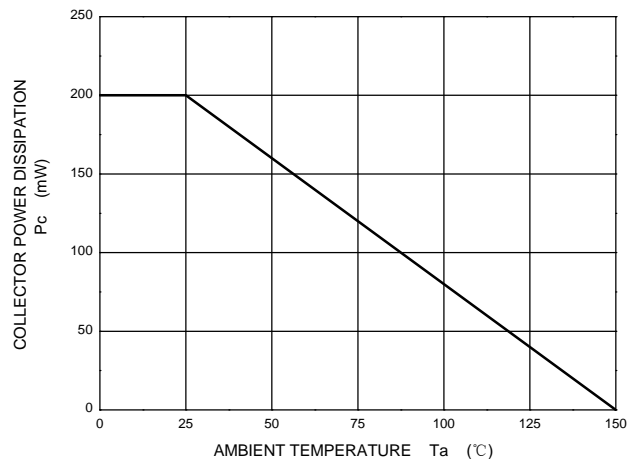

## SOT-23 Package Outline Dimensions

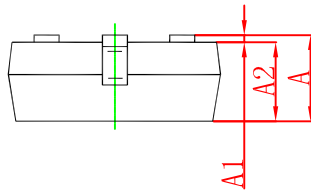
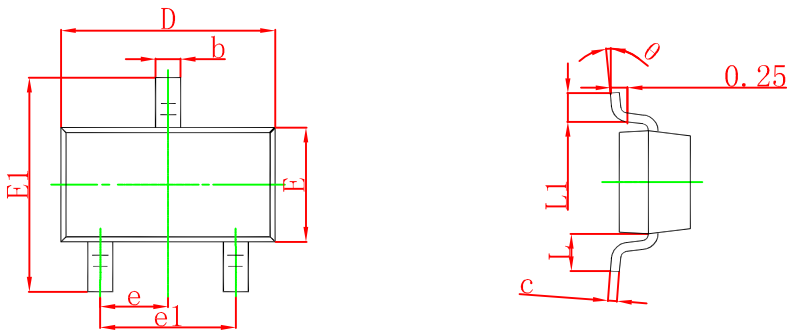

Symbol	Dimensions In Millimeters		Dimensions In Inches	
	Min	Max	Min	Max
A	0.900	1.150	0.035	0.045
A1	0.000	0.100	0.000	0.004
A2	0.900	1.050	0.035	0.041
b	0.300	0.500	0.012	0.020
c	0.080	0.150	0.003	0.006
D	2.800	3.000	0.110	0.118
E	1.200	1.400	0.047	0.055
E1	2.250	2.550	0.089	0.100
e	0.950 TYP		0.037 TYP	
e1	1.800	2.000	0.071	0.079
L	0.550 REF		0.022 REF	
L1	0.300	0.500	0.012	0.020
θ	0°	8°	0°	8°

## SOT-23 Suggested Pad Layout

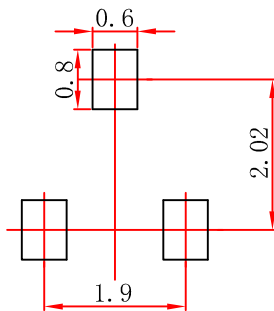

### Note:

1. Controlling dimension: in millimeters.
2. General tolerance:  $\pm 0.05$  mm.
3. The pad layout is for reference purposes only.

### NOTICE

JSCJ reserves the right to make modifications, enhancements, improvements, corrections or other changes without further notice to any product herein. JSCJ does not assume any liability arising out of the application or use of any product described herein.

# SOT-23 Tape and Reel

## SOT-23 Embossed Carrier Tape

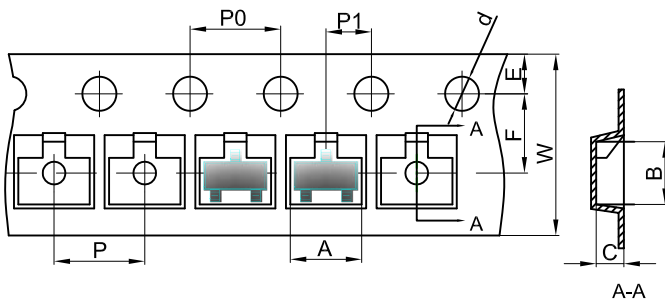

### Packaging Description:

SOT-23 parts are shipped in tape. The carrier tape is made from a dissipative (carbon filled) polycarbonate resin. The cover tape is a multilayer film (Heat Activated Adhesive in nature) primarily composed of polyester film, adhesive layer, sealant, and anti-static sprayed agent. These reeled parts in standard option are shipped with 3,000 units per 7" or 17.8cm diameter reel. The reels are clear in color and is made of polystyrene plastic (anti-static coated).

Dimensions are in millimeter

Pkg type	A	B	C	d	E	F	P0	P	P1	W
SOT-23	3.15	2.77	1.22	Ø1.50	1.75	3.50	4.00	4.00	2.00	8.00

## SOT-23 Tape Leader and Trailer

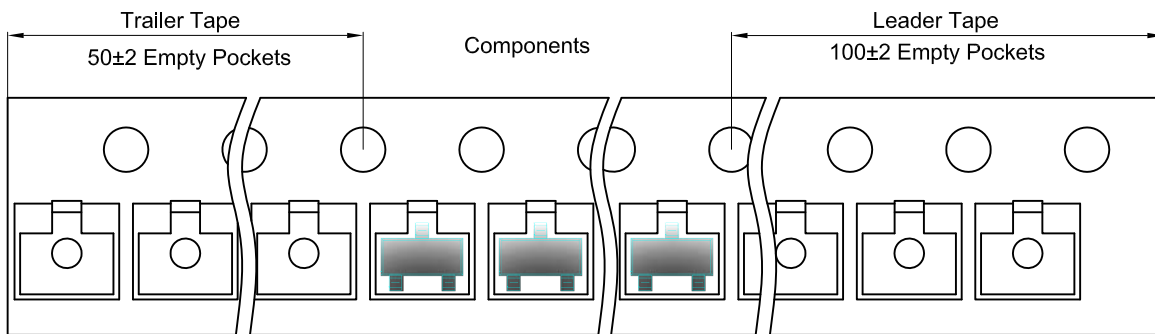

## SOT-23 Reel

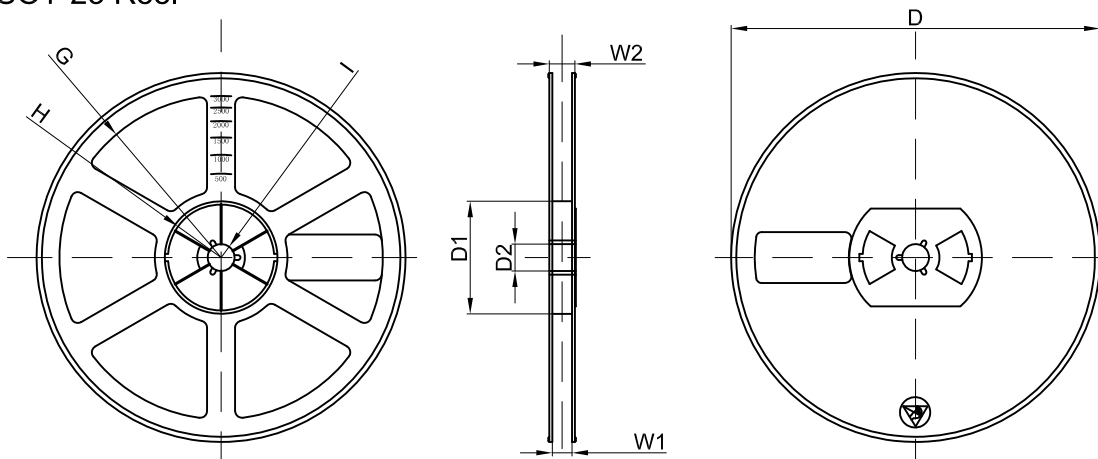

Dimensions are in millimeter

Reel Option	D	D1	D2	G	H	I	W1	W2
7" Dia	Ø178.00	54.40	13.00	R78.00	R25.60	R6.50	9.50	12.30

REEL	Reel Size	Box	Box Size(mm)	Carton	Carton Size(mm)	G.W.(kg)
3000 pcs	7 inch	45,000 pcs	203×203×195	180,000 pcs	438×438×220	

单击下面可查看定价，库存，交付和生命周期等信息

[>>JSCJ](#)