

TO-92 Plastic-Encapsulate Transistors

A42 TRANSISTOR (NPN)

FEATURES

- High voltage

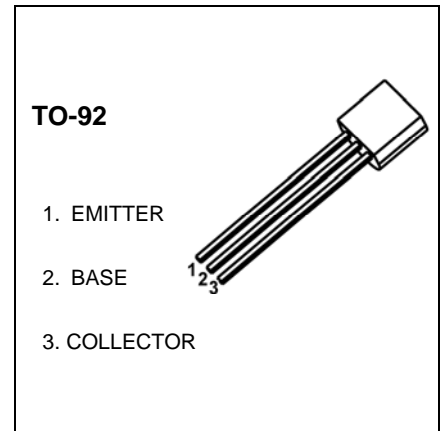

MARKING

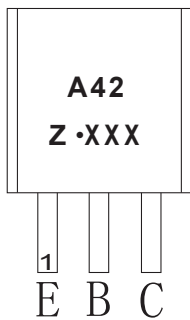

A42=Device code
 Solid dot=Green molding compound device,
 if none,the normal device
 Z=Rank of h_{FE}
 XXX=Code

Equivalent Circuit

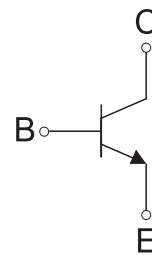

ORDERING INFORMATION

| Part Number | Package | Packing Method | Pack Quantity |
|-------------|---------|----------------|---------------|
| A42 | TO-92 | Bulk | 1000pcs/Bag |
| A42-TA | TO-92 | Tape | 2000pcs/Box |

MAXIMUM RATINGS ($T_a=25^{\circ}\text{C}$ unless otherwise noted)

| Symbol | Parameter | Value | Unit |
|-----------------|--|---------|--------------------------------|
| V_{CBO} | Collector-Base Voltage | 310 | V |
| V_{CEO} | Collector-Emitter Voltage | 305 | V |
| V_{EBO} | Emitter-Base Voltage | 5 | V |
| I_C | Collector Current -Continuous | 200 | mA |
| I_{CM} | Collector Current - Pulsed | 500 | mA |
| P_C | Collector Power Dissipation | 625 | mW |
| T_J, T_{stg} | Operation Junction and Storage Temperature Range | -55-150 | $^{\circ}\text{C}$ |
| $R_{\theta JA}$ | Thermal Resistance, junction to Ambient | 200 | $^{\circ}\text{C} / \text{mW}$ |
| $R_{\theta JC}$ | Thermal Resistance, junction to Case | 83.3 | $^{\circ}\text{C} / \text{mW}$ |

ELECTRICAL CHARACTERISTICS

$T_a=25^\circ\text{C}$ unless otherwise specified

| Parameter | Symbol | Test conditions | Min | Typ | Max | Unit |
|--------------------------------------|---------------|--|-----|-----|------|---------------|
| Collector-base breakdown voltage | $V_{(BR)CBO}$ | $I_C=100\mu\text{A}, I_E=0$ | 310 | | | V |
| Collector-emitter breakdown voltage | $V_{(BR)CEO}$ | $I_C=1\text{mA}, I_B=0$ | 305 | | | V |
| Emitter-base breakdown voltage | $V_{(BR)EBO}$ | $I_E=100\mu\text{A}, I_C=0$ | 5 | | | V |
| Collector cut-off current | I_{CBO} | $V_{CB}=200\text{V}, I_E=0$ | | | 0.25 | μA |
| Emitter cut-off current | I_{EBO} | $V_{EB}=5\text{V}, I_C=0$ | | | 0.1 | μA |
| DC current gain | $h_{FE(1)}$ | $V_{CE}=10\text{V}, I_C=1\text{mA}$ | 60 | | | |
| | $h_{FE(2)}$ | $V_{CE}=10\text{V}, I_C=10\text{mA}$ | 80 | | 250 | |
| | $h_{FE(3)}$ | $V_{CE}=10\text{V}, I_C=30\text{mA}$ | 75 | | | |
| Collector-emitter saturation voltage | $V_{CE(sat)}$ | $I_C=20\text{mA}, I_B=2\text{mA}$ | | | 0.2 | V |
| Base-emitter saturation voltage | $V_{BE(sat)}$ | $I_C=20\text{mA}, I_B=2\text{mA}$ | | | 0.9 | V |
| Transition frequency | f_T | $V_{CE}=20\text{V}, I_C=10\text{mA}, f=30\text{MHz}$ | 50 | | | MHz |

CLASSIFICATION OF $h_{FE(2)}$

| Rank | A | B | C |
|-------|--------|---------|---------|
| Range | 80-100 | 100-200 | 200-250 |

Typical Characteristics

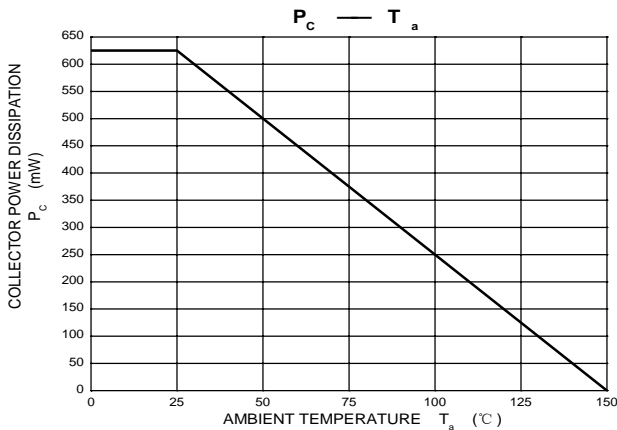
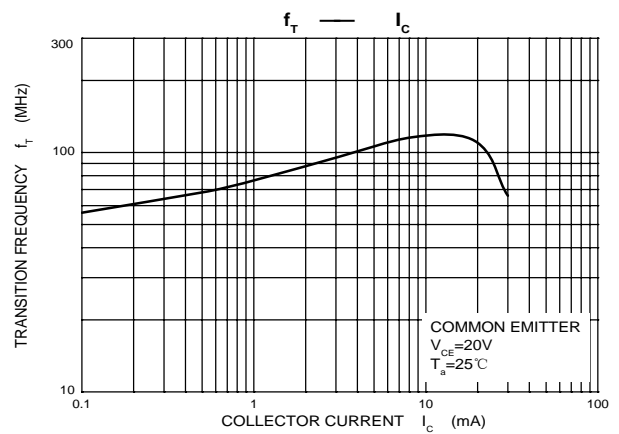
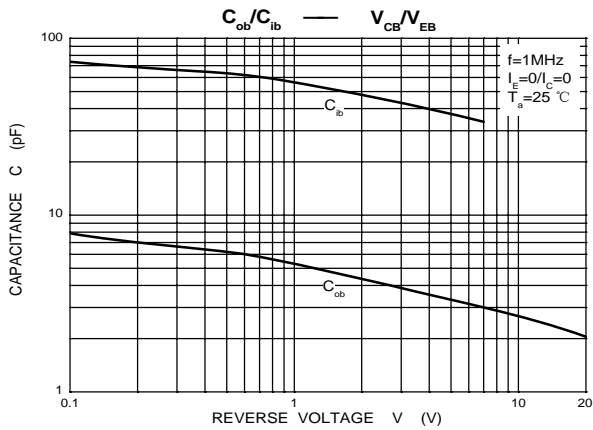
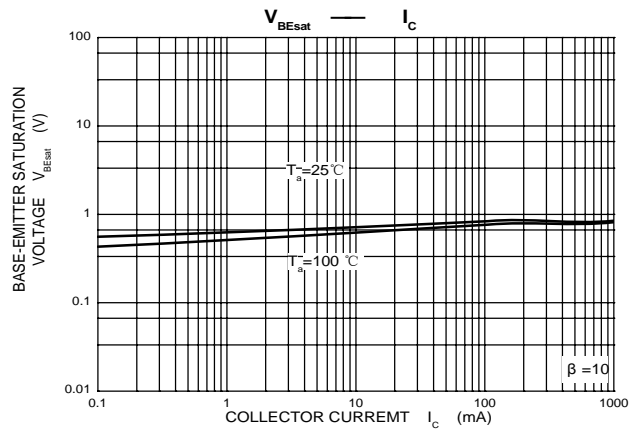
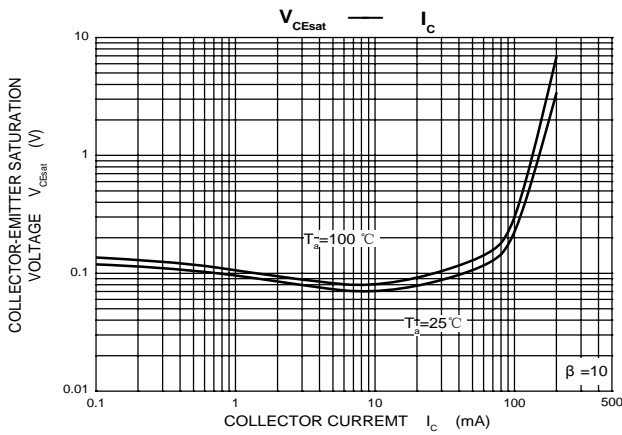
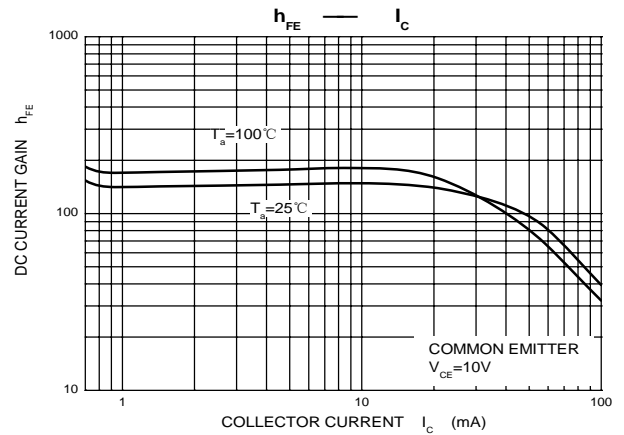
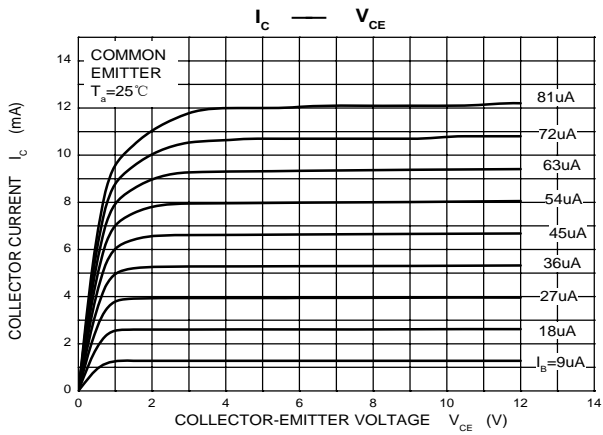

TO-92 Package Outline Dimensions

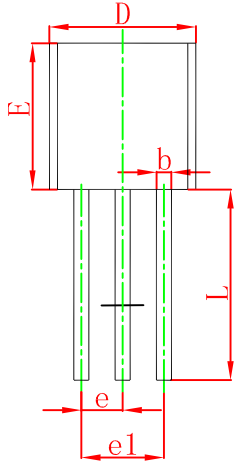
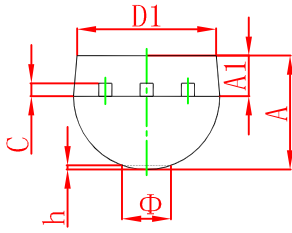

| Symbol | Dimensions In Millimeters | | Dimensions In Inches | |
|--------|---------------------------|--------|----------------------|-------|
| | Min | Max | Min | Max |
| A | 3.300 | 3.700 | 0.130 | 0.146 |
| A1 | 1.100 | 1.400 | 0.043 | 0.055 |
| b | 0.380 | 0.550 | 0.015 | 0.022 |
| c | 0.360 | 0.510 | 0.014 | 0.020 |
| D | 4.300 | 4.700 | 0.169 | 0.185 |
| D1 | 3.430 | | 0.135 | |
| E | 4.300 | 4.700 | 0.169 | 0.185 |
| e | 1.270 TYP | | 0.050 TYP | |
| e1 | 2.440 | 2.640 | 0.096 | 0.104 |
| L | 14.100 | 14.500 | 0.555 | 0.571 |
| Φ | | 1.600 | | 0.063 |
| h | 0.000 | 0.380 | 0.000 | 0.015 |

TO-92 Suggested Pad Layout

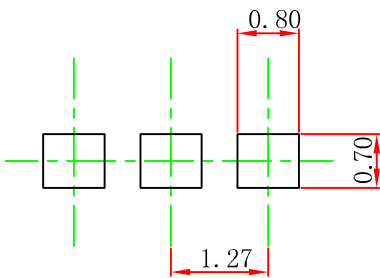

Note:

1. Controlling dimension: in millimeters.
2. General tolerance: $\pm 0.05\text{mm}$.
3. The pad layout is for reference purposes only.

NOTICE

JSCJ reserves the right to make modifications, enhancements, improvements, corrections or other changes without further notice to any product herein. JSCJ does not assume any liability arising out of the application or use of any product described herein.

TO-92 PACKAGE TAPING DIMENSION

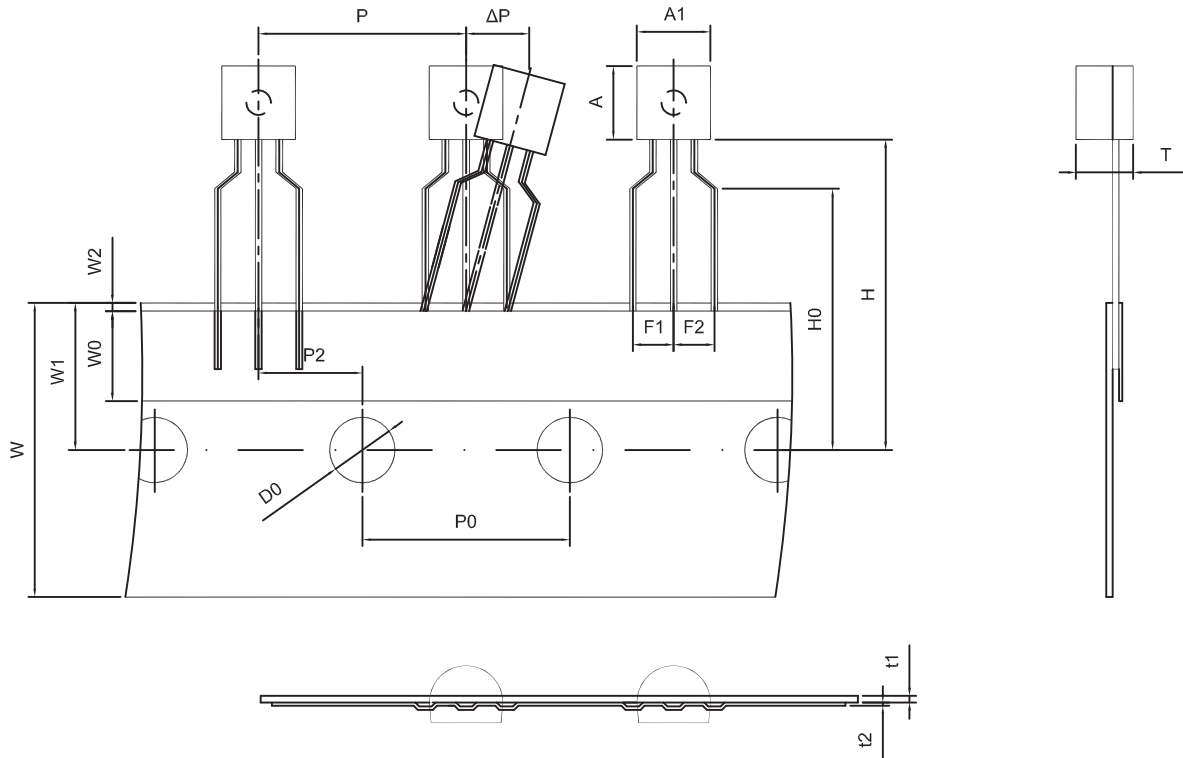

Dimensions are in millimeter

| | | | | | | | | |
|-----|-----|----------|------|------|------|-----|-----|------|
| A1 | A | T | P | P0 | P2 | F1 | F2 | W |
| 4.5 | 4.5 | 3.5 | 12.7 | 12.7 | 6.35 | 2.5 | 2.5 | 18.0 |
| W0 | W1 | W2 | H | H0 | D0 | t1 | t2 | ΔP |
| 6.0 | 9.0 | 1.0 MAX. | 19.0 | 16.0 | 4.0 | 0.4 | 0.2 | 0 |

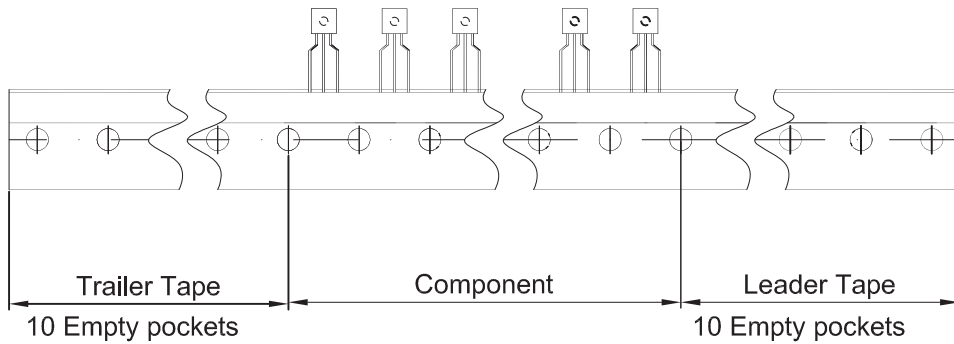

| | | | | |
|---------|----------|--------------|------------|-----------------|
| Package | Box | Box Size(mm) | Carton | Carton Size(mm) |
| TO-92 | 2000 pcs | 333×162×43 | 20,000 pcs | 350×340×250 |

单击下面可查看定价，库存，交付和生命周期等信息

[>>JSCJ](#)