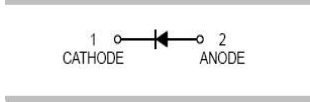


<p>Features</p> <ul style="list-style-type: none"> ● Low reverse current and low forward voltage ● High reliability ● Small surface mounting type <p>Typical Applications</p> <ul style="list-style-type: none"> ● For general purpose applications <p>Mechanical Data</p> <ul style="list-style-type: none"> ● Case: SOD-123,SOD-323 ● Molding compound, UL flammability classification rating 94V-0 ● Terminals: Tin plated leads, solderable per MIL-STD-202, Method 208 	<p>SOD-123 SOD323</p> 
---	--

Ordering Information

Part Number	Package	Shipping	Marking Code
B5818W	SOD-123	3000pcs / Tape & Reel	SK
B5818WS	SOD-323	3000pcs / Tape & Reel	SK
B5819W	SOD-123	3000pcs / Tape & Reel	SL
B5819WS	SOD-323	3000pcs / Tape & Reel	SL

Maximum Ratings (@T_A=25°C unless otherwise specified)

Parameter	Symbol	B5818W(S)	B5819W(S)	Units
Peak Repetitive Reverse Voltage	V _{RRM}	30	40	V
RMS Reverse Voltage	V _{RMS}	21	28	V
Maximum Average Forward Output Current	I _{F(AV)}	1		A
Peak Forward Surge Current, 8.3ms Single Half-sine-wave	I _{FSM}	10		A

Thermal Characteristics

Parameter	Symbol	B5818W/B5819W	B5818WS/B5819WS	Units
Power Dissipation	P _D	500	250	mW
Typical Thermal Resistance per leg	R _{θJA} *	200	400	°C/W
Operating Junction Temperature Range	T _J	125		°C
Storage Temperature Range	T _{STG}	-55 to +150		°C

* Part mounted on FR-4 board with recommended pad layout

Electrical Characteristics (@ $T_A=25^\circ\text{C}$ unless otherwise specified)

Parameter	Symbol	Test conditions	Min.	Typ.	Max.	Units
Forward Voltage	V_F^*	$I_F=1\text{A}$ B5818W(S)	-	-	0.55	V
		$I_F=1\text{A}$ B5819W(S)			0.60	
		$I_F=3\text{A}$ B5818W(S)			0.875	
		$I_F=3\text{A}$ B5819W(S)	-	-	0.90	
Maximum Peak Reverse Current	I_R^{**}	$V_R=30\text{V}$ $V_R=40\text{V}$	-	-	1	mA
Capacitance Between Terminals	C_T	$V_R=4\text{V}, f=1\text{MHz}$	-	39	120	pF

*Pulse width $\leq 380\ \mu\text{s}$, Duty cycle $< 2\%$
 **pulse test, $t_p \leq 5\text{ms}$

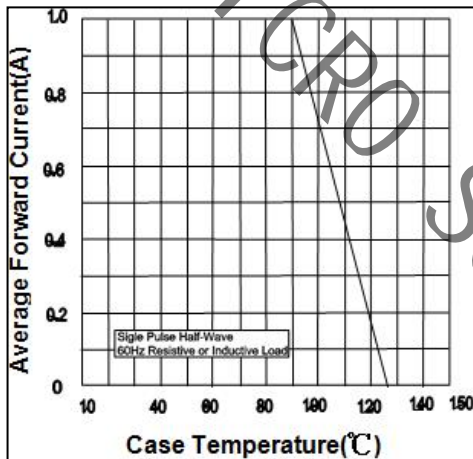
Ratings and Characteristic Curves ($T_A=25^\circ\text{C}$ unless otherwise noted)


Fig.1 Forward Current Derating Curve

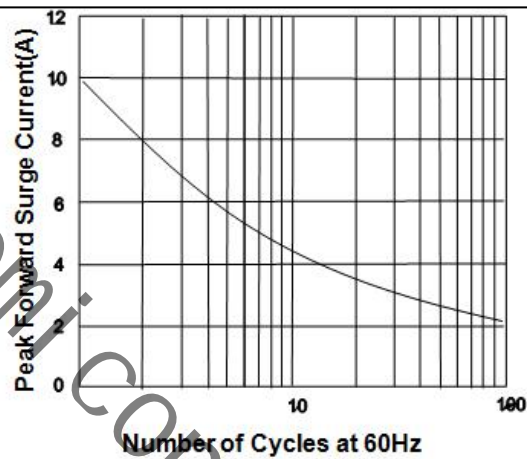


Fig.2 Maximum Non-Repetitive Peak Forward Surge Current

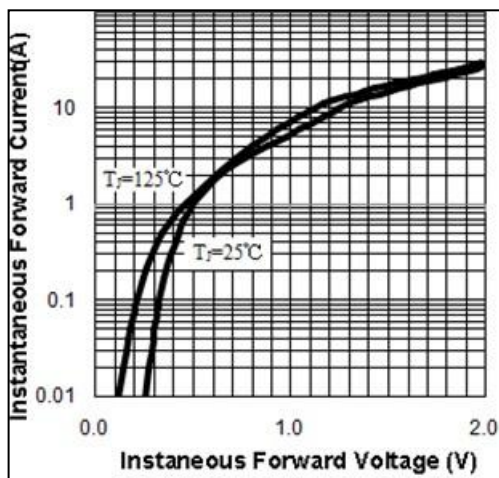


Fig.3 Typical Instantaneous Forward Characteristics

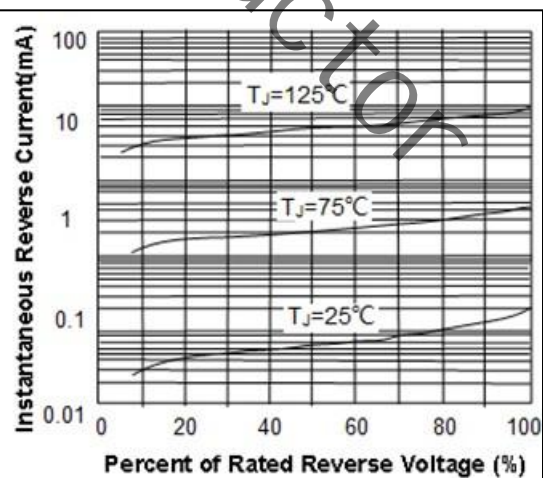
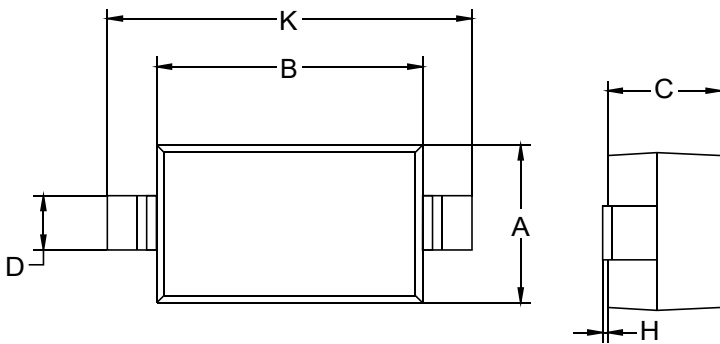
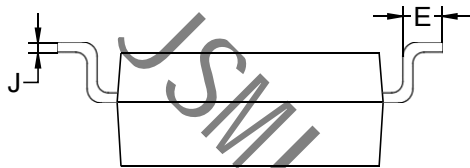
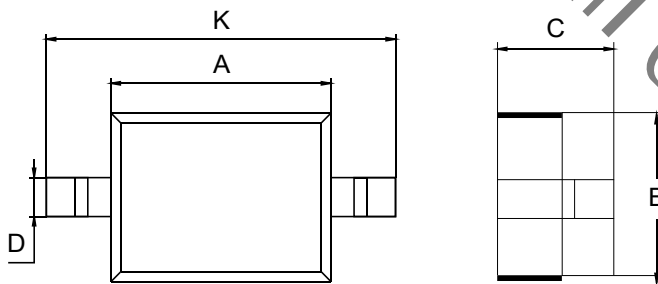


Fig.4 Typical Reverse Characteristics

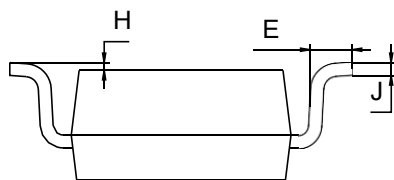
Package Outline Dimensions (unit: mm)

SOD-123


SOD-123		
Dim	Min	Max
A	1.45	1.75
B	2.55	2.85
C	1.00	1.30
D	0.50	0.60
E	0.25	0.45
H	0.02	0.10
J	0.05	0.15
K	3.55	3.85

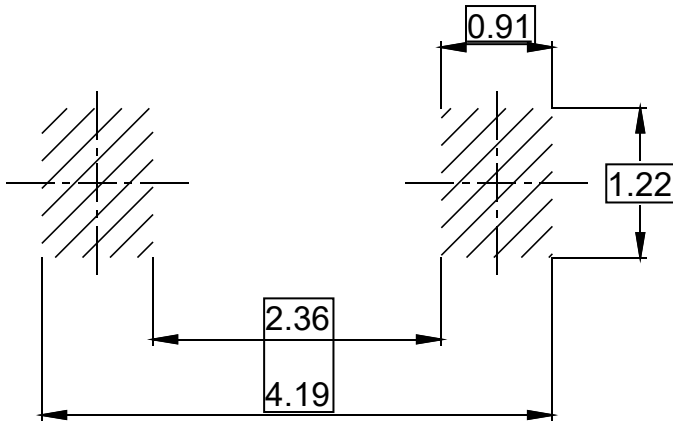

SOD-323


SOD-323		
Dim	Min	Max
A	1.60	1.80
B	1.20	1.40
C	0.80	0.90
D	0.25	0.35
E	0.22	0.42
H	0.02	0.10
J	0.05	0.15
K	2.55	2.75

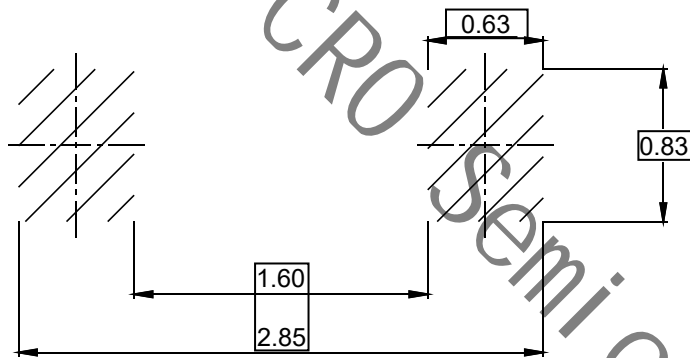


Mounting Pad Layout (unit: mm)

SOD-123



SOD-323



单击下面可查看定价，库存，交付和生命周期等信息

[>>JSMSEMI\(杰盛微\)](#)