

Description:

This N-Channel MOSFET uses advanced trench technology and design to provide excellent $R_{DS(on)}$ with low gate charge. It can be used in a wide variety of applications.

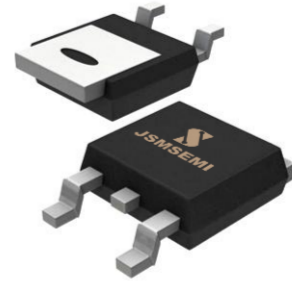

Features:

- 1) $V_{DS}=30V, I_D=80A, R_{DS(ON)} < 5.5 m \Omega @ V_{GS}=10V$
- 2) Low gate charge.
- 3) Green device available.
- 4) Advanced high cell density trench technology for ultra low $R_{DS(ON)}$.
- 5) Excellent package for good heat dissipation.

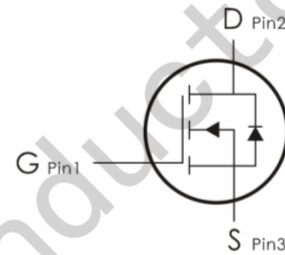

Absolute Maximum Ratings: ($T_C=25^\circ C$ unless otherwise noted)

Symbol	Parameter	Ratings	Units
V_{DS}	Drain-Source Voltage	30	V
V_{GS}	Gate-Source Voltage	± 20	V
I_D	Continuous Drain Current- $T_C=25^\circ C$	80	A
	Continuous Drain Current- $T_C=100^\circ C$	46	
	Pulsed Drain Current ¹	280	
E_{AS}	Single Pulse Avalanche Energy ²	56	mJ
P_D	Power Dissipation, $T_C=25^\circ C$	46	W
T_J, T_{STG}	Operating and Storage Junction Temperature Range	-55 to +150	$^\circ C$

Thermal Characteristics:

Symbol	Parameter	Max	Units
$R_{\theta JC}$	Thermal Resistance, Junction to Case	2.72	$^\circ C/W$

Electrical Characteristics: ($T_c=25^\circ\text{C}$ unless otherwise noted)

Symbol	Parameter	Conditions	Min	Typ	Max	Units
Off Characteristics						
BV_{DSS}	Drain-Source Breakdown Voltage	$V_{GS}=0V, I_D=250\ \mu\text{A}$	30	---	---	V
I_{DSS}	Zero Gate Voltage Drain Current	$V_{GS}=0V, V_{DS}=30V$	---	---	1	μA
I_{GSS}	Gate-Source Leakage Current	$V_{GS}=\pm 20V, V_{DS}=0A$	---	---	± 100	nA
On Characteristics						
$V_{GS(th)}$	GATE-Source Threshold Voltage	$V_{GS}=V_{DS}, I_D=250\ \mu\text{A}$	1	1.5	2.5	V
$R_{DS(ON)}$	Drain-Source On Resistance ³	$V_{GS}=10V, I_D=30A$	---	4.2	5.5	$\text{m}\Omega$
		$V_{GS}=4.5V, I_D=20A$	---	7.5	12	
Dynamic Characteristics						
C_{iss}	Input Capacitance	$V_{DS}=15V, V_{GS}=0V, f=1\text{MHz}$	---	1614	---	pF
C_{oss}	Output Capacitance		---	245	---	
C_{rss}	Reverse Transfer Capacitance		---	215	---	
Switching Characteristics						
$t_{d(on)}$	Turn-On Delay Time	$V_{DD}=15V, I_D=30A,$ $V_{GS}=10V, R_{GEN}=3\Omega$	---	7.5	---	ns
t_r	Rise Time		---	14.5	---	ns
$t_{d(off)}$	Turn-Off Delay Time		---	35.2	---	ns
t_f	Fall Time		---	9.6	---	ns
Q_g	Total Gate Charge	$V_{GS}=10V, V_{DS}=15V,$ $I_D=30A$	---	33.7	---	nC
Q_{gs}	Gate-Source Charge		---	8.5	---	nC
Q_{gd}	Gate-Drain "Miller" Charge		---	7.5	---	nC
Drain-Source Diode Characteristics						
V_{SD}	Source-Drain Diode Forward Voltage	$V_{GS}=0V, I_S=30A$	---	---	1.2	V
I_S	Continuous Source Current	---	---	---	80	A
I_{sm}	Pulsed Source Current		---	---	280	A

- Notes: 1. Repetitive Rating: Pulse Width Limited by Maximum Junction Temperature
 2. EAS condition: $T_J=25^\circ\text{C}, V_{DD}=15V, V_G=10V, R_G=25\ \Omega, L=0.5\text{mH}, I_{AS}=15A$
 3. Pulse Test: Pulse Width $\leq 300\mu\text{s}$, Duty Cycle $\leq 0.5\%$

Typical Characteristics: ($T_c=25^\circ\text{C}$ unless otherwise noted)

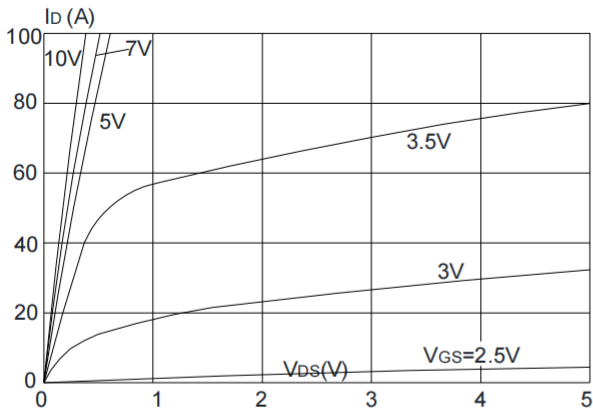

Figure 1: Output Characteristics

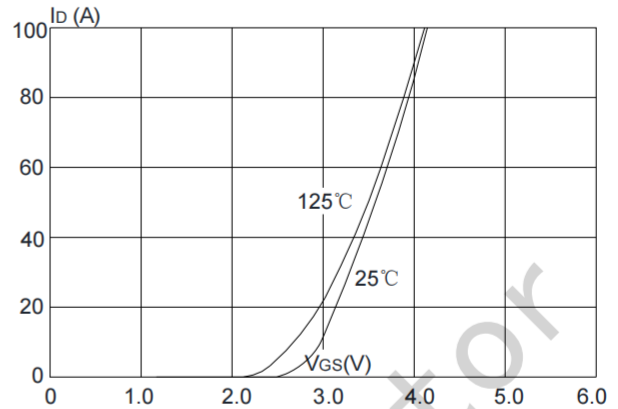

Figure 2: Typical Transfer Characteristics

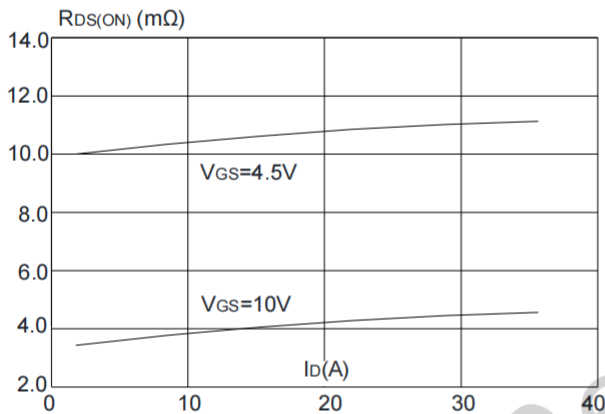

Figure 3: On-resistance vs. Drain Current

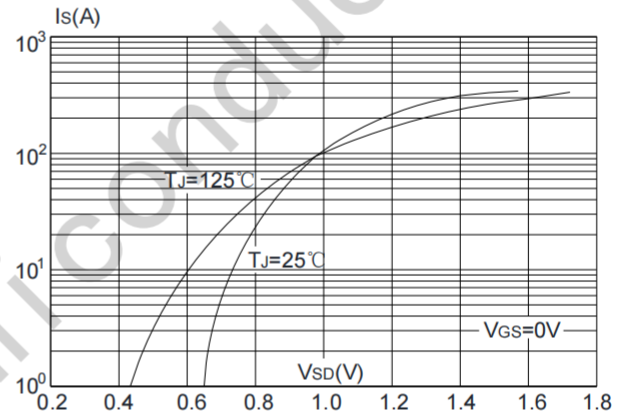

Figure 4: Body Diode Characteristics

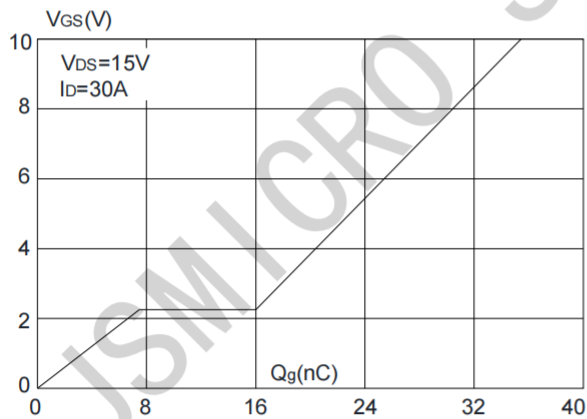

Figure 5: Gate Charge Characteristics

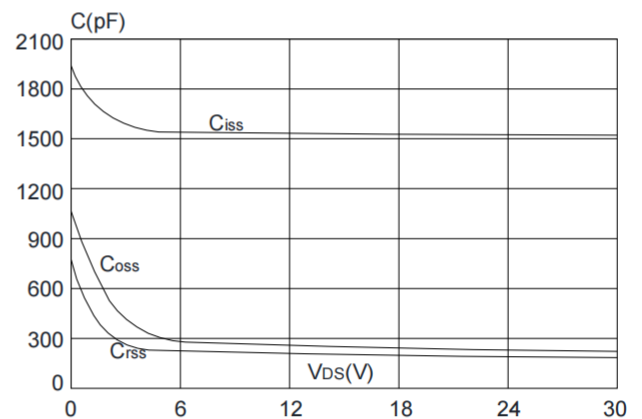

Figure 6: Capacitance Characteristics

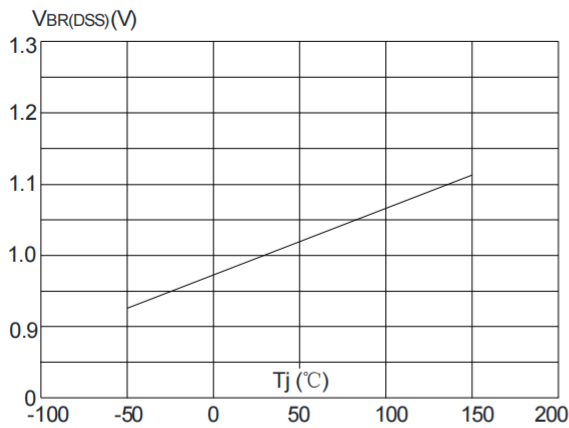

Figure 7: Normalized Breakdown Voltage vs. Junction Temperature

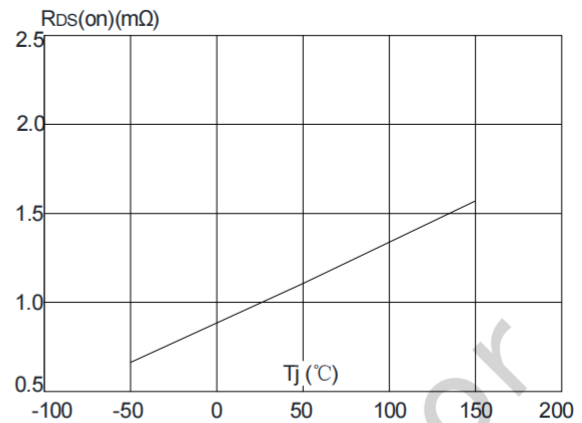

Figure 8: Normalized on Resistance vs. Junction Temperature

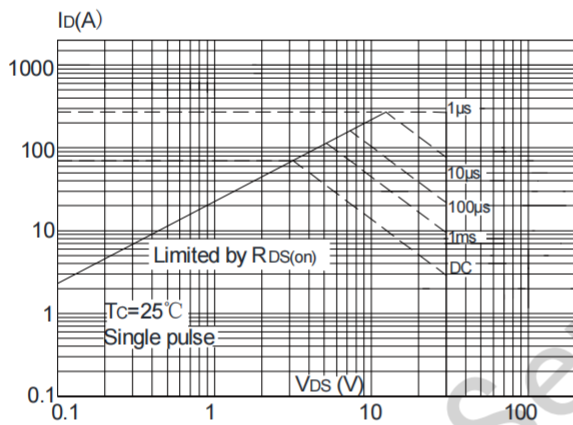

Figure 9: Maximum Safe Operating Area

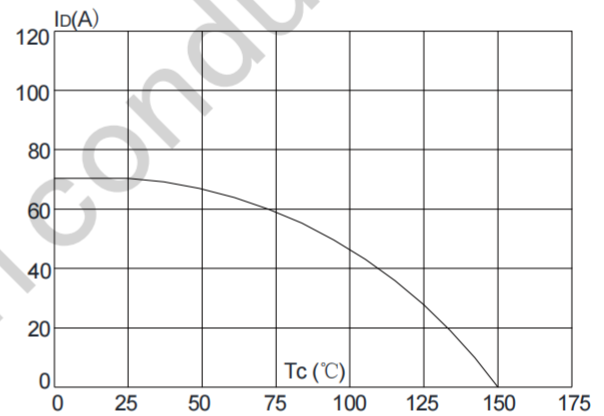

Figure 10: Maximum Continuous Drain Current vs. Case Temperature

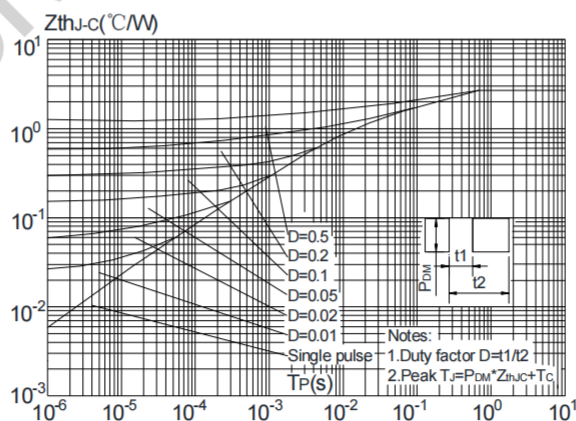
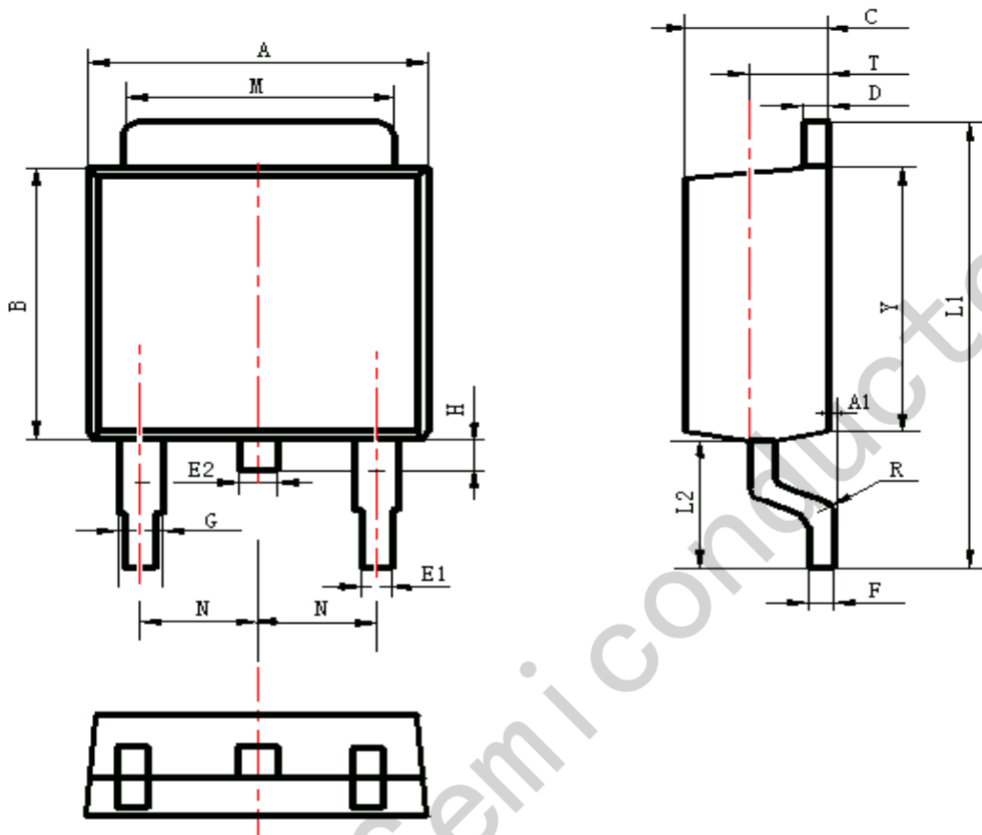

Figure.11: Maximum Effective Transient Thermal Impedance, Junction-to-Case

Package Information

TO-252



Symbol	Dimensions In Millimeters		Dimensions In Inches	
	Min.	Max.	Min.	Max.
A	6.30	6.90	0.248	0.272
A1	0.00	0.16	0.000	0.006
B	5.70	6.30	0.224	0.248
C	2.10	2.50	0.083	0.098
D	0.30	0.70	0.012	0.028
E1	0.60	0.90	0.024	0.035
E2	0.70	1.00	0.028	0.039
F	0.30	0.60	0.012	0.024
G	0.70	1.20	0.028	0.047
L1	9.60	10.50	0.378	0.413
L2	2.70	3.10	0.106	0.122
H	0.40	1.00	0.016	0.039
M	5.10	5.50	0.201	0.217
N	2.09	2.49	0.082	0.098
R	0.30		0.012	
T	1.40	1.60	0.055	0.063
Y	5.10	6.30	0.201	0.248

单击下面可查看定价，库存，交付和生命周期等信息

[>>JSMSEMI\(杰盛微\)](#)