

PUD CONNECTOR

2.0 mm pitch/Wire-to-Board connectors/Crimp style and Mating style

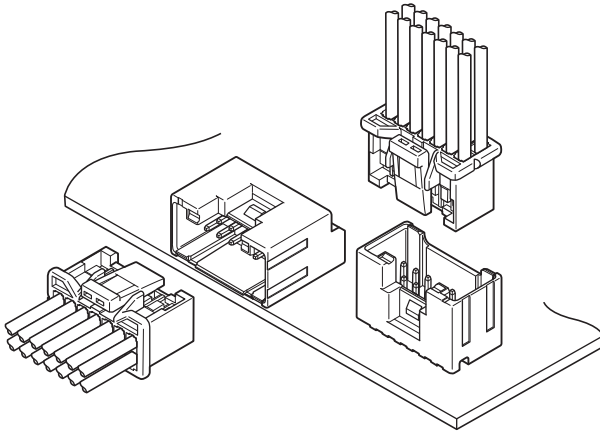

This is a 2.0 mm pitch, double-row, wire-to-board connector with a secure lock mechanism. It provides stable contact performance against vibration, prying, low voltage and low current circuits while achieving low insertion force.

Aside from the locking tab structure, the connector housing and header perfectly align which allows for high precision in facilitating board mount design.

- High reliability contact
- Superior operability
- Secure lock mechanism
- Polarizing key for mounting on PC board
- Reinforcement tabs for through-hole reflow specifications (For side entry header with SMT contacts only)

Standards

:Recognized E 60389

:Certified LR 20812

Specifications

- Current rating: 3 A AC/DC (AWG #22)
- Voltage rating: 250 V AC/DC
- Temperature range: -25°C to +85°C
(including temperature rise in applying electrical current)
- Contact resistance:
Initial value/ 10 mΩ max.
After environmental tests/ 20 mΩ max.
- Insulation resistance: 1,000 MΩ min.
- Withstanding voltage:
There shall be no breakdown or flashover while applying 800 VAC for one minute.
- Applicable wire range:
Conductor size/ AWG #28 to AWG #22
Insulation O.D./ ϕ 0.76 mm to ϕ 1.5 mm
- * In using the products, refer to "Handling Precautions for Terminals and Connectors" described on our website (Technical documents of Product information page).
- * RoHS2 compliance
- * Dimensional unit: mm
- * Contact JST for details.

PUD CONNECTOR

PC board layout and Assembly layout/ DIP type

Top entry type

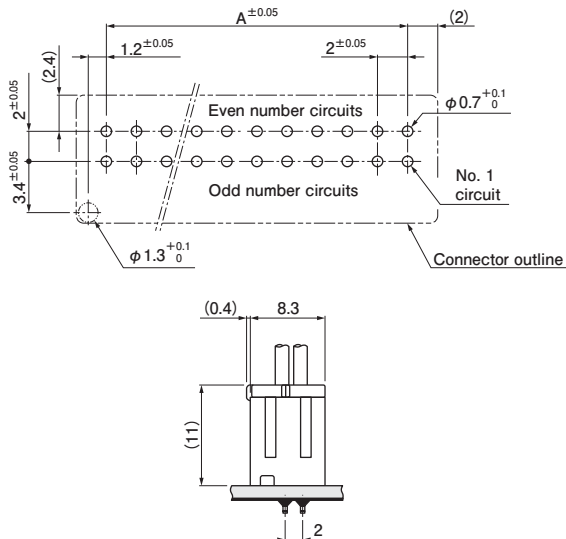

Side entry type

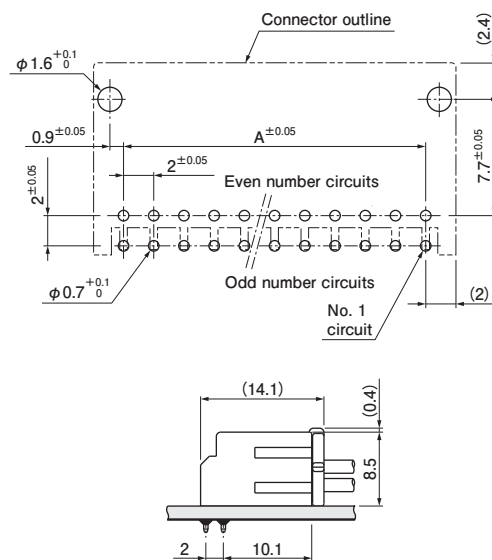

- Note: 1. The figure of PC board layout is the figure viewed from the connector mounting side.
 2. Dimension A: See "Header/ DIP type" section on page 4.
 3. Tolerance for the PCB hole pitch shall be ± 0.05 , and shall not accumulate more than ± 0.05 .
 4. Hole dimensions differ according to the type of PC board and piercing method.
 5. The above dimensions are reference values. Please contact JST for details.

PC board layout and Assembly layout/ SMT type

Top entry type

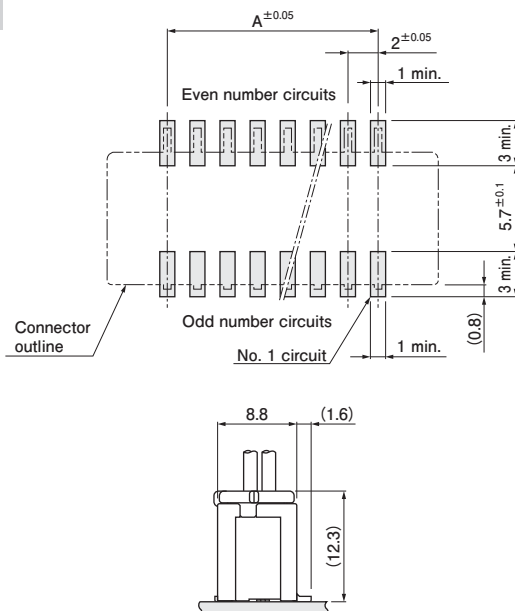

Side entry type

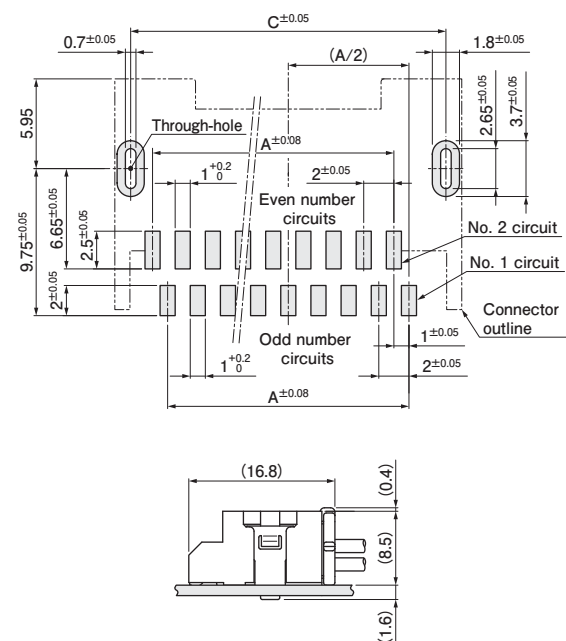

- Note: 1. The figure of PC board layout is the figure viewed from the connector mounting side.
 2. Dimension A: See "Header/ SMT type" section on page 6.
 3. Tolerance for the PCB pattern pitch shall be ± 0.05 , and shall not accumulate more than ± 0.05 .
 4. The above dimensions are reference values. Please contact JST for details.

- Note: 1. The figure of PC board layout is the figure viewed from the connector mounting side.
 2. Dimensions A and C: See "Header/ SMT type" section on page 7.
 3. Tolerance for the PCB pattern pitch shall be ± 0.05 , and shall not accumulate more than ± 0.05 .
 4. Reinforcement tabs are through-hole reflow compatible.
 5. Recommended PC board thickness : 1.2 mm to 1.6 mm
 6. The above dimensions are reference values. Please contact JST for details.

PUD CONNECTOR

Contact

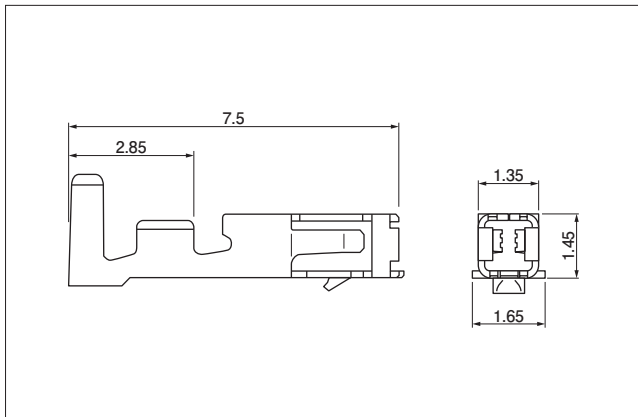

Model No.	Applicable wire range		Q'ty/ reel	
	Conductor size	AWG (mm ²)		Insulation O.D. (mm)
SPUD-002T-P0.5	#28 to #24	(0.08 to 0.22)	0.76 to 1.5	8,000
SPUD-001T-P0.5	#26 to #22	(0.13 to 0.33)	0.95 to 1.5	8,000

Material and Surface finish, etc.

Copper alloy, tin-plated

Crimping machine

Contact	Crimping machine	Applicator	Crimp applicator with dies
SPUD-002T-P0.5	AP-K2N	MKS-L	APLMK SPUD002-05
SPUD-001T-P0.5			APLMK SPUD001-05

Note: Contact JST for fully automatic crimping applicator.

Housing

<8, 10 circuits>

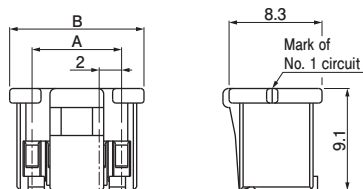

<12, 14 circuits>

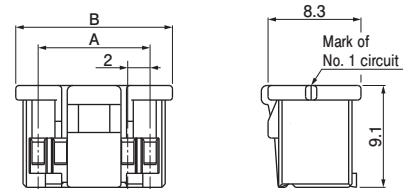

<16, 18 circuits>

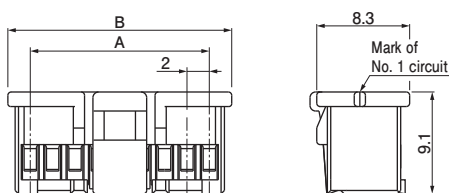

<20, 22 circuits>

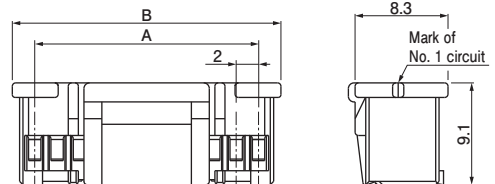

<24 to 28 circuits>

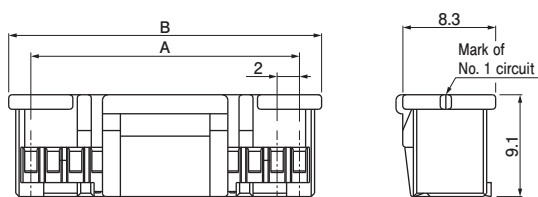

<30 to 40 circuits>

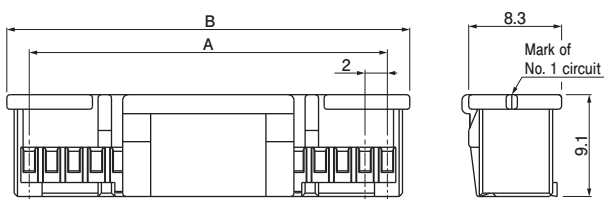

No. of circuits	Model No.	Dimensions (mm)		Q'ty/bag
		A	B	
8	PUDP-08V-S	6.0	10.0	1,000
10	PUDP-10V-S	8.0	12.0	1,000
12	PUDP-12V-S	10.0	14.0	1,000
14	PUDP-14V-S	12.0	16.0	1,000
16	PUDP-16V-S	14.0	18.0	1,000
18	PUDP-18V-S	16.0	20.0	1,000
20	PUDP-20V-S	18.0	22.0	1,000
22	PUDP-22V-S	20.0	24.0	1,000
24	PUDP-24V-S	22.0	26.0	1,000
26	PUDP-26V-S	24.0	28.0	1,000
28	PUDP-28V-S	26.0	30.0	500
30	PUDP-30V-S	28.0	32.0	500
32	PUDP-32V-S	30.0	34.0	500
34	PUDP-34V-S	32.0	36.0	500
36	PUDP-36V-S	34.0	38.0	500
38	PUDP-38V-S	36.0	40.0	500
40	PUDP-40V-S	38.0	42.0	500

Material and Surface finish, etc.

PBT, UL94V-0, natural

PUD CONNECTOR

Header/ DIP type

Top entry type <8, 10 circuits>

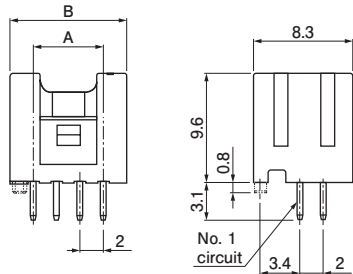

<12 to 18 circuits>

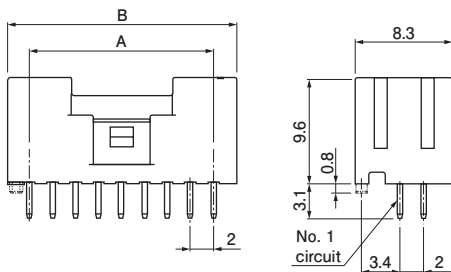

<20 to 40 circuits>

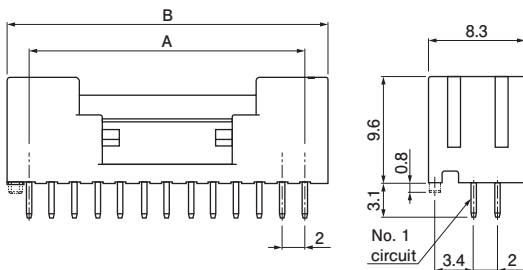

Top entry type

No. of circuits	Model No.		Dimensions (mm)		Q'ty/ bag
	Without boss	With boss	A	B	
8	B08B-PUDSS	B08B-PUDSS-1	6.0	10.0	3,300
10	B10B-PUDSS	B10B-PUDSS-1	8.0	12.0	2,750
12	B12B-PUDSS	B12B-PUDSS-1	10.0	14.0	2,310
14	B14B-PUDSS	B14B-PUDSS-1	12.0	16.0	1,980
16	B16B-PUDSS	B16B-PUDSS-1	14.0	18.0	1,760
18	B18B-PUDSS	B18B-PUDSS-1	16.0	20.0	1,650
20	B20B-PUDSS	B20B-PUDSS-1	18.0	22.0	1,430
22	B22B-PUDSS	B22B-PUDSS-1	20.0	24.0	1,320
24	B24B-PUDSS	B24B-PUDSS-1	22.0	26.0	1,210
26	B26B-PUDSS	B26B-PUDSS-1	24.0	28.0	1,100
28	B28B-PUDSS	B28B-PUDSS-1	26.0	30.0	1,100
30	B30B-PUDSS	B30B-PUDSS-1	28.0	32.0	990
32	B32B-PUDSS	B32B-PUDSS-1	30.0	34.0	880
34	B34B-PUDSS	B34B-PUDSS-1	32.0	36.0	880
36	B36B-PUDSS	B36B-PUDSS-1	34.0	38.0	770
38	B38B-PUDSS	B38B-PUDSS-1	36.0	40.0	770
40	B40B-PUDSS	B40B-PUDSS-1	38.0	42.0	770

Material and Surface finish, etc.

Post: Copper alloy, copper-undercoated, tin-plated
Wafer: PA 66 (Glass-filled), UL94V-0, natural

Note: This product displays (LF) (SN) on a label.

PUD CONNECTOR

Header/ DIP type

Side entry type

<8, 10 circuits>

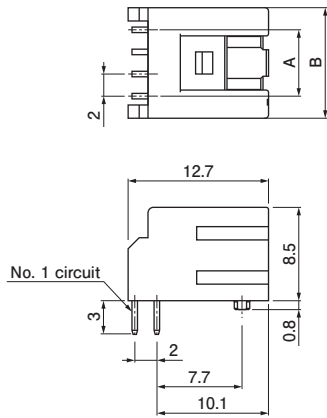

<12 to 18 circuits>

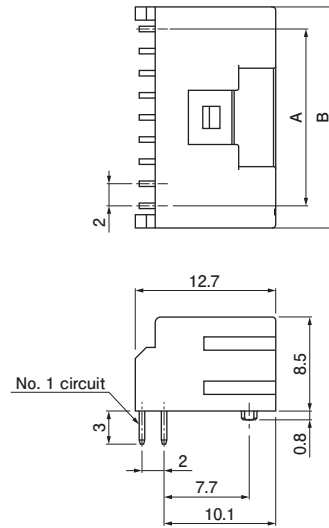

<20 to 40 circuits>

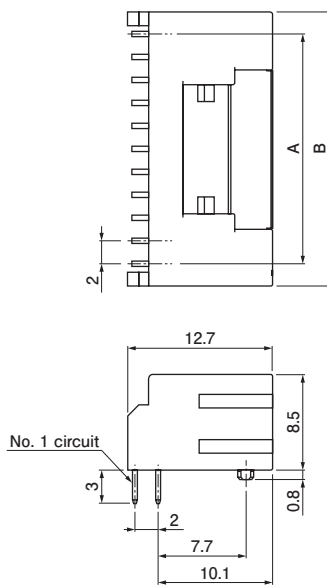

Side entry type

No. of circuits	Model No.	Dimensions (mm)		Q'ty/bag
		A	B	
8	S08B-PUDSS-1	6.0	10.0	3,300
10	S10B-PUDSS-1	8.0	12.0	2,750
12	S12B-PUDSS-1	10.0	14.0	2,310
14	S14B-PUDSS-1	12.0	16.0	1,980
16	S16B-PUDSS-1	14.0	18.0	1,760
18	S18B-PUDSS-1	16.0	20.0	1,650
20	S20B-PUDSS-1	18.0	22.0	1,430
22	S22B-PUDSS-1	20.0	24.0	1,320
24	S24B-PUDSS-1	22.0	26.0	1,210
26	S26B-PUDSS-1	24.0	28.0	1,100
28	S28B-PUDSS-1	26.0	30.0	1,100
30	S30B-PUDSS-1	28.0	32.0	990
32	S32B-PUDSS-1	30.0	34.0	880
34	S34B-PUDSS-1	32.0	36.0	880
36	S36B-PUDSS-1	34.0	38.0	770
38	S38B-PUDSS-1	36.0	40.0	770
40	S40B-PUDSS-1	38.0	42.0	770

Material and Surface finish, etc.

Post: Copper alloy, copper-undercoated, tin-plated
Wafer: PA 66 (Glass-filled), UL94V-0, natural

Note: This product displays (LF) (SN) on a label.

PUD CONNECTOR

Header/ SMT type

Top entry type

<10 circuits>

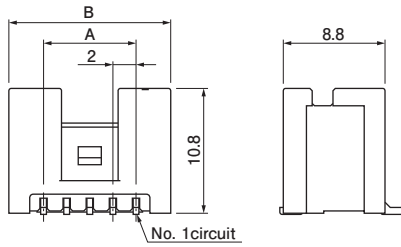

<12 to 18 circuits>

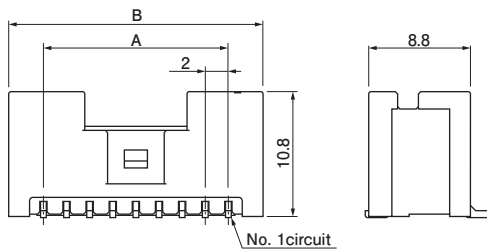

<20, 22 circuits>

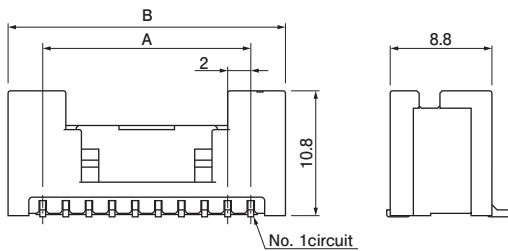

<24 to 28 circuits>

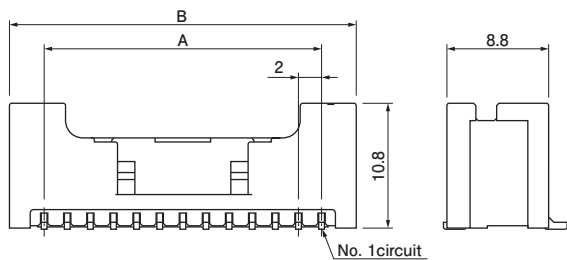

<30 to 40 circuits>

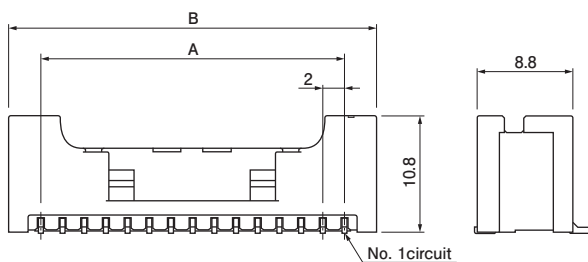

Top entry type

No. of circuits	Model No.	Dimensions (mm)		Q'ty/reel
		A	B	
10	BM10B-PUDSS-TFC	8.0	14.0	400
12	BM12B-PUDSS-TFC	10.0	16.0	400
14	BM14B-PUDSS-TFC	12.0	18.0	400
16	BM16B-PUDSS-TFC	14.0	20.0	400
18	BM18B-PUDSS-TFC	16.0	22.0	400
20	BM20B-PUDSS-TFC	18.0	24.0	400
22	BM22B-PUDSS-TFC	20.0	26.0	400
24	BM24B-PUDSS-TFC	22.0	28.0	400
26	BM26B-PUDSS-TFC	24.0	30.0	400
28	BM28B-PUDSS-TFC	26.0	32.0	400
30	BM30B-PUDSS-TFC	28.0	34.0	400
32	BM32B-PUDSS-TFC	30.0	36.0	400
34	BM34B-PUDSS-TFC	32.0	38.0	400
36	BM36B-PUDSS-TFC	34.0	40.0	400
38	BM38B-PUDSS-TFC	36.0	42.0	400
40	BM40B-PUDSS-TFC	38.0	44.0	400

Material and Surface finish, etc.

Contact: Copper alloy, copper-undercoated, tin-plated
Wafer: Polyamide, UL94V-0, natural

Note: This product displays (LF) (SN) on a label.

PUD CONNECTOR

Header/ SMT type

Side entry type

<10 circuits>

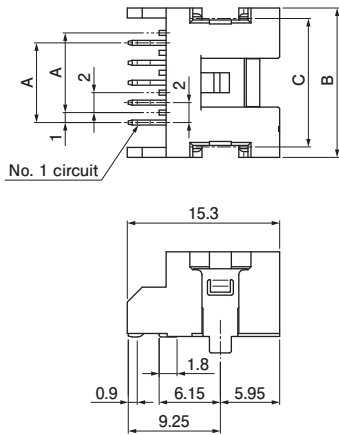

<12, 16 circuits>

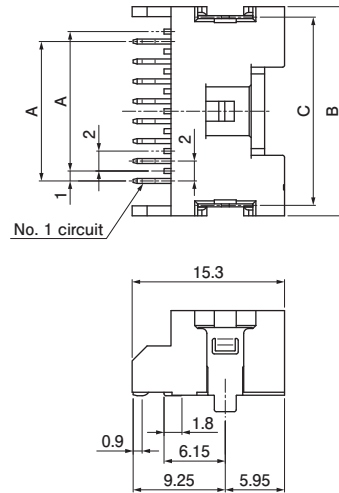

<22 circuits>

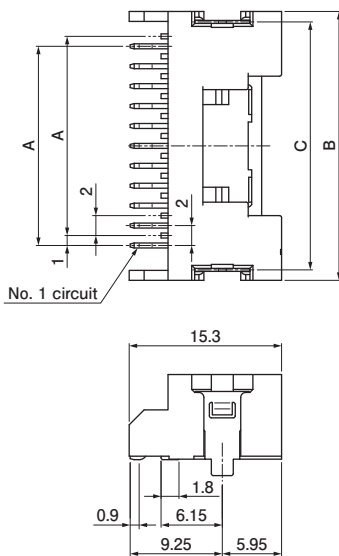

Side entry type

No. of circuits	Model No.	Dimensions (mm)			Q'ty/reel
		A	B	C	
10	SM10B-PUDK-D-ETB (HF)	8.0	15.0	12.9	300
12	SM12B-PUDK-D-ETB (HF)	10.0	17.0	14.9	300
16	SM16B-PUDK-D-ETB (HF)	14.0	21.0	18.9	300
22	SM22B-PUDK-D-ETB (HF)	20.0	27.0	24.9	300

Material and Surface finish, etc.

Header pin for odd-numbered rows (top):

Copper alloy, copper-undercoated, tin-plated

Contacts for even-numbered rows (bottom):

Copper alloy, copper-undercoated, tin-plated

Reinforcement tabs: Copper alloy, copper-undercoated, tin-plated

Wafer: LCP, UL94V-0, Black

Note: Unlisted in the CSA Standard.

PUD CONNECTOR

Model number allocation

Contact

S PUD - 001 T - P 0.5

Supply form: Strip form

Series name

Applicable wire range:
002...AWG #28 to AWG #24
001...AWG #26 to AWG #22

Surface finish: Tin-plated

Material: Copper alloy

Applicable post size

Housing

PUD P - 08 V - S

Series name

Type: Plug

No. of circuits

Flammability: UL94V-0

Color: S...Natural, Z...Ivory, E...Blue, R...Red,
K...Black, TR...Tomato red, MG...Moss green,
DPK...Dark pink, CB...Cobalt blue,
DO...Dark orange, DP...Dark purple,
DH...Dark gray, LE...Light blue

Header/ DIP type

B 08 B - PUD S S - 1

Header type : B...Top entry type
S...Side entry type

No. of circuits

Assembly product

Series name

Color: S...Natural, Z...Ivory, E...Blue, R...Red,
K...Black, TR...Tomato red, MG...Moss green,
DPK...Dark pink, CB...Cobalt blue,
DO...Dark orange, DP...Dark purple,
DH...Dark gray, LE...Light blue

Clinched (Kinked)/ Not clinched: Straight

Presence of boss: Blank...Without boss, 1...With boss

Header/ SMT type, Top entry type

BM 10 B - PUD S S - TF C

Header type : SMT top entry type

No. of circuits

Assembly product

Series name

Color: S...Natural, Z...Ivory, K...Black,
TR...Tomato red, MG...Moss green,
DPK...Dark pink, CB...Cobalt blue, ,
DO...Dark orange, DP...Dark purple

Auxiliary symbol

Packaging style: Embossed-taping

Presence of suction cap: With suction cap

Header/ SMT type, Side entry type

SM 10 B - PUD K - D - ETB (HF)

Header type:
SMT side entry type

No. of circuits

Assembly product

Series name

Color: Black

Reinforcement tab soldering specifications:
Through-hole reflow

Packaging style: Antistatic embossed-taping

Halogen-free

单击下面可查看定价，库存，交付和生命周期等信息

[>>JST\(杰世腾\)](#)