

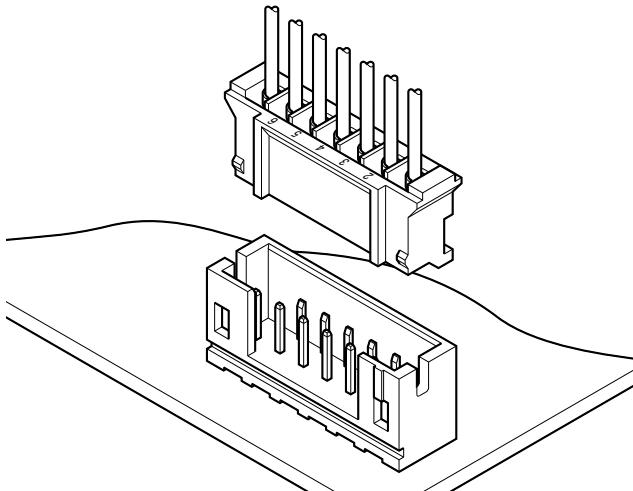

# PH CONNECTOR

2.0 mm pitch/Disconnectable Crimp style connectors

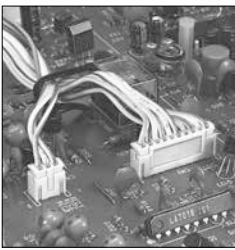

This is a thin, low-profile 2.0 mm pitch connector 8.0 mm in height after mounting and 4.5 mm in width. It is designed to meet the demand for high-density connection of internal wires to printed circuit boards. It is compact, highly reliable and low in cost.

- Reliable contact
- Fully shrouded header
- Printed circuit board retention mechanism
- Surface mount model (SMT)

## Specifications

- Current rating: 2 A AC/DC (AWG #24)
- Voltage rating: 100 V AC/DC
- Temperature range: -25°C to +85°C  
(including temperature rise in applying electrical current)
- Contact resistance: Initial value/ 10 mΩ max.  
After environmental tests/ 20 mΩ max.
- Insulation resistance: 1,000 MΩ min.
- Withstanding voltage: 800 VAC/ minute
- Applicable wire: AWG #32 to #24
- Applicable PC board thickness: 0.8 to 1.6 mm

\* In using the products, refer to "Handling Precautions for Terminals and Connectors" described on our website (Technical documents of Product information page).

\* RoHS2 compliance

\* Dimensional unit: mm

\* Contact JST for details.

## Standards

Ⓜ Recognized E60389

⚠ R75087

## PC board layout and Assembly layout

### <Through-hole type>

#### Top entry type

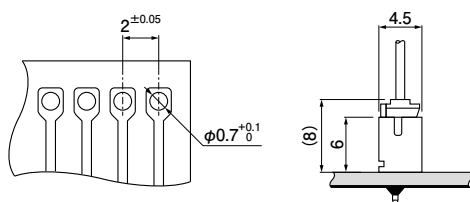

#### Side entry type

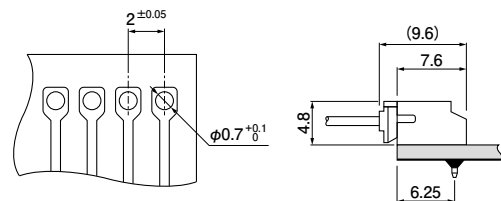

Note: 1. The above figure is the figure viewed from soldering side.

2. Tolerances are non-cumulative: ± 0.05 mm for all centers.

3. Hole dimensions differ according to the type of PC board and piercing method. If PC boards made of hard material are used, the hole dimensions should be larger. The dimensions above should serve as a guideline. Contact JST for details.

### <SMT type>

#### SM4 type

#### Top entry type

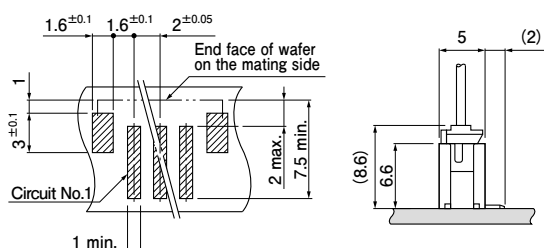

#### SM4 type

#### Side entry type

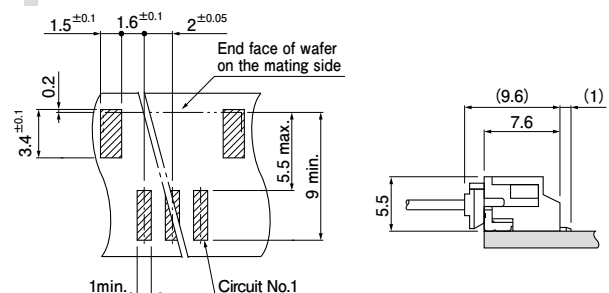

Note: 1. The above figure is the figure viewed from the connector mounting side.

2. Tolerances are non-cumulative: ± 0.05 mm for all centers.

3. The dimensions above should serve as a guideline. Contact JST for details.

# PH CONNECTOR

## Contact

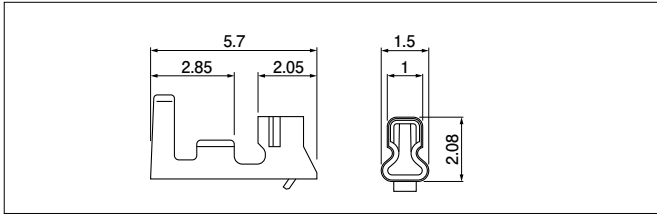

Model No.	Applicable wire			Q'ty/ reel
	mm <sup>2</sup>	AWG #	Insulation O.D. (mm)	
SPH-002T-P0.5S	0.05 to 0.22	30 to 24	0.8 to 1.5	8,000
SPH-002T-P0.5L	0.08 to 0.22	28 to 24	0.8 to 1.5	
SPH-004T-P0.5S	0.032 to 0.08	32 to 28	0.5 to 0.9	10,000

### Material and Finish

Phosphor bronze, tin-plated (reflow treatment)

### RoHS2 compliance

Note: 1. Contact JST for gold-plated products.

2. SPH-002T-P0.5L is low-insertion force type contact, for easier insertion/ withdrawal, which would be less resistant to the vibration. The crimp height is different from the standard.

3. Contact JST for details.

Contact	Crimping machine	Applicator		
		Crimp applicator	Dies	Crimp applicator with dies
SPH-002T-P0.5S	AP-K2N	MKS-L	MK/SPH-002-05S	APLMK SPH002-05S
SPH-002T-P0.5L			MK/SPH-002-05L	APLMK SPH002-05L
SPH-004T-P0.5S		MKS-L-10	MK/SPH-002-05S	APLMK SPH004-05S

Note: Contact JST for fully automatic crimping applicator.

## Housing

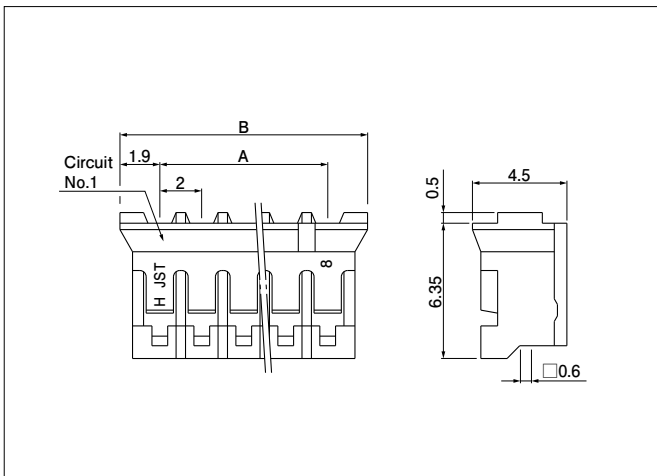

No. of circuits	Model No.	Dimensions (mm)		Q'ty/ bag
		A	B	
2	PHR-2	2.0	5.8	2,000
3	PHR-3	4.0	7.8	2,000
4	PHR-4	6.0	9.8	2,000
5	PHR-5	8.0	11.8	2,000
6	PHR-6	10.0	13.8	2,000
7	PHR-7	12.0	15.8	2,000
8	PHR-8	14.0	17.8	1,000
9	PHR-9	16.0	19.8	1,000
10	PHR-10	18.0	21.8	1,000
11	PHR-11	20.0	23.8	1,000
12	PHR-12	22.0	25.8	1,000
13	PHR-13	24.0	27.8	1,000
14	PHR-14	26.0	29.8	1,000
15	PHR-15	28.0	31.8	1,000
16	PHR-16	30.0	33.8	1,000

### Material and Finish

PA 66, UL94V-0, natural (white)

### RoHS2 compliance

## Header

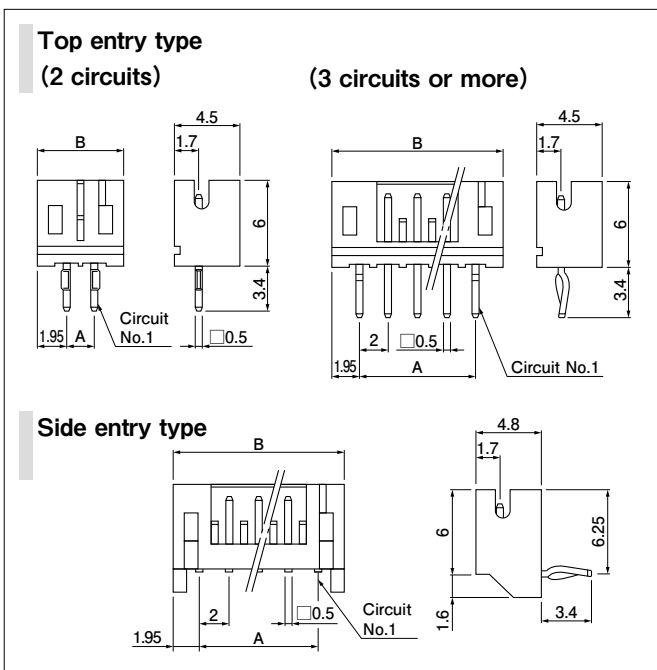

No. of circuits	Model No.		Dimensions (mm)		Q'ty/box	
	Top entry type	Side entry type	A	B	Top entry type	Side entry type
2	B2B-PH-K-S	S2B-PH-K-S	2.0	5.9	1,000	1,000
3	B3B-PH-K-S	S3B-PH-K-S	4.0	7.9	1,000	1,000
4	B4B-PH-K-S	S4B-PH-K-S	6.0	9.9	1,000	500
5	B5B-PH-K-S	S5B-PH-K-S	8.0	11.9	1,000	500
6	B6B-PH-K-S	S6B-PH-K-S	10.0	13.9	1,000	500
7	B7B-PH-K-S	S7B-PH-K-S	12.0	15.9	500	500
8	B8B-PH-K-S	S8B-PH-K-S	14.0	17.9	500	250
9	B9B-PH-K-S	S9B-PH-K-S	16.0	19.9	500	250
10	B10B-PH-K-S	S10B-PH-K-S	18.0	21.9	500	250
11	B11B-PH-K-S	S11B-PH-K-S	20.0	23.9	500	250
12	B12B-PH-K-S	S12B-PH-K-S	22.0	25.9	400	250
13	B13B-PH-K-S	S13B-PH-K-S	24.0	27.9	250	250
14	B14B-PH-K-S	S14B-PH-K-S	26.0	29.9	250	250
15	B15B-PH-K-S	S15B-PH-K-S	28.0	31.9	250	200
16	B16B-PH-K-S	S16B-PH-K-S	30.0	33.9	250	200

### Material and Finish

Post: Brass, copper-undercoated, tin-plated (reflow treatment)  
Wafer: PA 66, UL94V-0, natural (white)

RoHS2 compliance This product displays (LF)(SN) on a label.

# PH CONNECTOR

## Header (Low insertion force type)

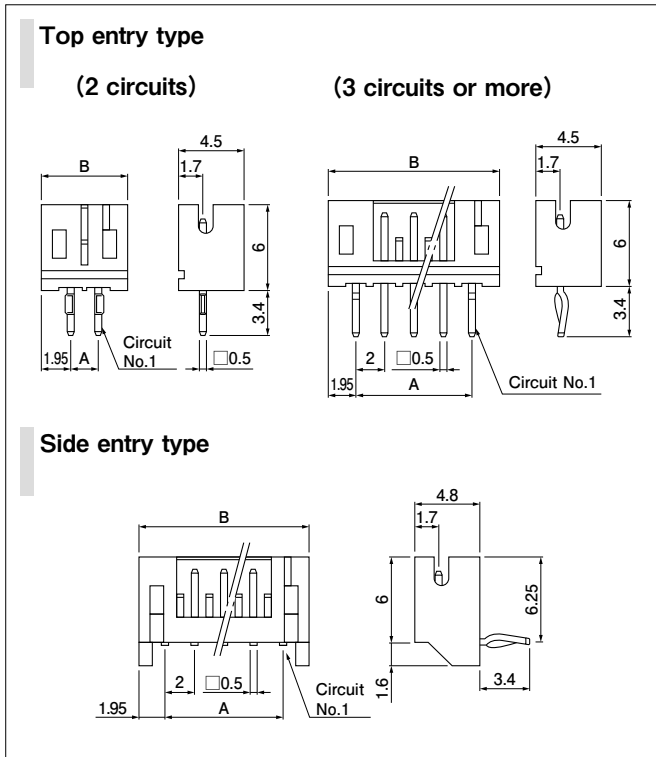

No. of circuits	Model No.		Dimensions (mm)		Q'ty/box	
	Top entry type	Side entry type	A	B	Top entry type	Side entry type
2	B2B-PH-KL	S2B-PH-KL	2.0	5.9	1,000	1,000
3	B3B-PH-KL	S3B-PH-KL	4.0	7.9	1,000	1,000
4	B4B-PH-KL	S4B-PH-KL	6.0	9.9	1,000	500
5	B5B-PH-KL	S5B-PH-KL	8.0	11.9	1,000	500
6	B6B-PH-KL	S6B-PH-KL	10.0	13.9	1,000	500
7	B7B-PH-KL	S7B-PH-KL	12.0	15.9	500	500
8	B8B-PH-KL	S8B-PH-KL	14.0	17.9	500	250
9	B9B-PH-KL	S9B-PH-KL	16.0	19.9	500	250
10	B10B-PH-KL	S10B-PH-KL	18.0	21.9	500	250
11	B11B-PH-KL	S11B-PH-KL	20.0	23.9	500	250
12	B12B-PH-KL	S12B-PH-KL	22.0	25.9	400	250
13	B13B-PH-KL	S13B-PH-KL	24.0	27.9	250	250
14	B14B-PH-KL	S14B-PH-KL	26.0	29.9	250	200
15	B15B-PH-KL	S15B-PH-KL	28.0	31.9	250	200
16	B16B-PH-KL	S16B-PH-KL	30.0	33.9	250	200

### Material and Finish

Post: Copper alloy, copper-undercoated, tin-plated (reflow treatment)  
Wafer: PA 66, UL94V-0, gray

**RoHS2 compliance** This product displays (LF)(SN) on a label.

## Header (SMT type)

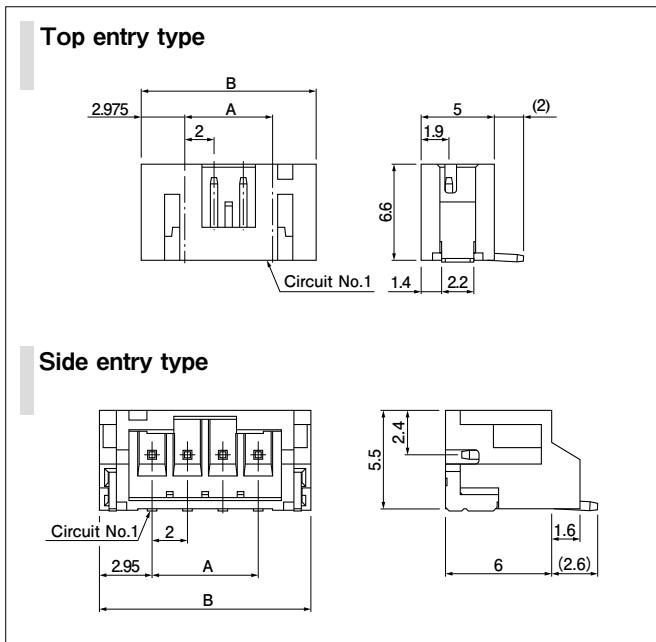

No. of circuits	Model No.		Dimensions (mm)			Q'ty/reel
	Top entry type	Side entry type	A	B		
				Top entry type	Side entry type	
2	B2B-PH-SM4-TB	S2B-PH-SM4-TB	2.0	7.95	7.9	1,000
3	B3B-PH-SM4-TB	S3B-PH-SM4-TB	4.0	9.95	9.9	1,000
4	B4B-PH-SM4-TB	S4B-PH-SM4-TB	6.0	11.95	11.9	1,000
5	B5B-PH-SM4-TB	S5B-PH-SM4-TB	8.0	13.95	13.9	1,000
6	B6B-PH-SM4-TB	S6B-PH-SM4-TB	10.0	15.95	15.9	1,000
7	B7B-PH-SM4-TB	S7B-PH-SM4-TB	12.0	17.95	17.9	1,000
8	B8B-PH-SM4-TB	S8B-PH-SM4-TB	14.0	19.95	19.9	1,000
9	B9B-PH-SM4-TB	S9B-PH-SM4-TB	16.0	21.95	21.9	1,000
10	B10B-PH-SM4-TB	S10B-PH-SM4-TB	18.0	23.95	23.9	1,000
11	B11B-PH-SM4-TB	S11B-PH-SM4-TB	20.0	25.95	25.9	1,000
12	B12B-PH-SM4-TB	S12B-PH-SM4-TB	22.0	27.95	27.9	1,000
13	B13B-PH-SM4-TB	S13B-PH-SM4-TB	24.0	29.95	29.9	1,000
14	B14B-PH-SM4-TB	S14B-PH-SM4-TB	26.0	31.95	31.9	1,000
15	B15B-PH-SM4-TB	S15B-PH-SM4-TB	28.0	33.95	33.9	1,000
16	B16B-PH-SM4-TB	—	30.0	35.95	—	1,000

### Material and Finish

Post: Copper alloy, copper-undercoated, tin-plated (reflow treatment)  
Wafer: PA, UL94V-0, natural (ivory)  
Solder tab: Brass, copper-undercoated, tin-plated (reflow treatment)

**RoHS2 compliance** This product displays (LF)(SN) on a label.  
Note: Contact JST for the top entry type headers with suction cap.

# PH CONNECTOR

## Model number allocation

### Contact

**S PH - 002 T - P 0.5 S**

Form: S...Strip form

Series name

Applicable wire range:  
 Normal type 002...AWG #30 to #24  
 004...AWG #32 to #28  
 Low insertion force type 002...AWG #28 to #24

Surface finish: T...Tin-plated (reflow treatment)

Material: P...Phosphor bronze

Terminal size

Type name: S...Normal type, L...Low insertion force type

### Housing

**PH R - 2 -**

Series name

Part name: Receptacle

No. of circuits: 2 to 16

Color: None...Natural (White), BK...Black, R...Red, TR...Tomato red, BL...Blue, Y...Yellow, L...Lemon yellow, M...Green, D...Orange, N...Brown, P...Purple, PK...Pink, H...Gray, LE...Light blue, FY...Fluorescent yellow, DPK...Dark pink

### Header

**B 2 B - PH - K - S**

Shape of assembled product:  
 B...Top entry type S...Side entry type

No. of circuits: Top and side entry types...2 to 16

Part name: Header

Series name

Indication of clinch: K...Clinched

Color: S...Natural (White), K...Black, R...Red, TR...Tomato red, E...Blue, Y...Yellow, L...Lemon yellow, M...Green, O...Orange, N...Brown, P...Purple, PK...Pink, H...Gray, LE...Light blue, FY...Fluorescent yellow, None...Ivory

### Header (Low insertion force type)

**B 2 B - PH - K L -**

Shape of assembled product:  
 B...Top entry type, S...Side entry type

No. of circuits: Top and side entry types...2 to 16

Part name: Header

Series name

Indication of clinch: K...Clinched

Type name: L...Low insertion force type

Color: None...Gray, R...Red, E...Blue, S...Natural (White)

### Header (SMT type)

**B 2 B - PH - SM4 - - TB**

Shape of assembled product:  
 B...Top entry type  
 S...Side entry type

No. of circuits:  
 Top entry type...2 to 16  
 Side entry type...2 to 15

Part name: Header

Series name

SMT specification: SM4...With solder tab

Color: None...Natural (Ivory), R...Red, E...Blue, M...Green, L...Lemon yellow, K...Black, DPK...Dark pink

Packaging style: TB...Embossed-taping

Suction tape: None...Without suction tape, T...With suction tape

Note: Depending on the colors, it may take some time for delivery.

单击下面可查看定价，库存，交付和生命周期等信息

[>>JST\(杰世腾\)](#)