

PA FAMILY/PA • PAF • PAL CONNECTORS

2.0 mm pitch/Wire-to-board (Crimp style/IDC style) / Wire-to-wire (Crimp style/IDC style)

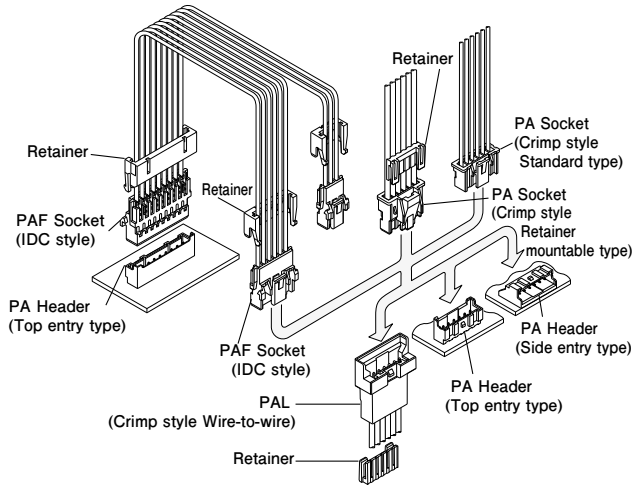

The 2.0 mm pitch PA family consists of the following connectors:

- PA connector (Wire-to-board crimp style)
- PAF connector (Wire-to-board insulation displacement connection (IDC) style)
- PAL connector (Wire-to-wire crimp style)

These features enabled a harness with complicated shape for the first time as a 2.0 mm pitch connector with secure locking mechanism.

- Secure locking device
- Interchangeable between crimp and IDC socket
- Secondary retainers
- Harness variation

PA connector (Standard type, Retainer mountable type)

- Highly reliable contact
- Insertion guide mechanism
- Flanged press pin

PAF connector

- The industry's first secure lock IDC connectors
- Metallic strain relief
- Retainer with four locking points

PAL connector

- The industry's first wire to wire 2.0 mm pitch retainer mountable type connector.
- Either with or without panel lock can be selected according to application.

Standards

☑ Recognized E60389

Specifications

PA Connector (Standard type)

- Current rating: 3 A AC/DC (AWG #22)
- Voltage rating: 250 V AC/DC
- Temperature range: -25°C to +85°C
(including temperature rise in applying electrical current)
- Contact resistance: Initial value/ 10 mΩ max.
After environmental tests/ 20 mΩ max.
- Insulation resistance: Initial/ 1,000 MΩ min.
- Withstanding voltage: 800 VAC/minute
- Applicable wire: Conductor size/ AWG #28 to #22
Insulation O.D./ 0.76 to 1.5 mm
- Applicable PC board thickness: 1.6 mm

PA Connector (Retainer mountable type)

- Current rating: 3 A AC/DC (AWG #22)
- Voltage rating: 100 V AC/DC
- Temperature range: -25°C to +85°C
(including temperature rise in applying electrical current)
- Contact resistance: Initial value/ 15 mΩ max.
After environmental tests/ 25 mΩ max.
- Insulation resistance: Initial/ 1,000 MΩ min.
- Withstanding voltage: 800 V AC/minute
- Applicable wire: AWG #26 to #22

PAF Connector

- Current rating: 1.0 A AC/DC (AWG #26)
- Voltage rating: 100 V AC/DC
- Temperature range: -25°C to +85°C
(including temperature rise in applying electrical current)
- Contact resistance: Initial value/ 15 mΩ max.
After environmental tests/ 25 mΩ max.
- Insulation resistance: Initial/ 1,000 MΩ min.
- Withstanding voltage: 800 VAC/minute
- Applicable wire: UL1061(Contact JST for details regarding other UL wires.)
AWG #26
Conductor/ 7 strands, tin-coated annealed copper
Insulation O.D./ 0.9 to 1.0 mm

PAL Connector

- Current rating: 3 A AC/DC (AWG #22)
- Voltage rating: 100 V AC/DC
- Temperature range: -25°C to +85°C
(including temperature rise in applying electrical current)
- Contact resistance: Initial value/ 15 mΩ max.
After environmental tests/ 25 mΩ max.
- Insulation resistance: Initial/ 1,000 MΩ min.
- Withstanding voltage: 800 VAC/minute
- Applicable wire: AWG #28 to #22
- Applicable panel thickness : 0.5 to 2.0 mm

* In using the products, refer to "Handling Precautions for Terminals and Connectors" described on our website (Technical documents of Product information page).

- * RoHS2 compliance
- * Dimensional unit: mm
- * Contact JST for details.

PA FAMILY/PA • PAF • PAL CONNECTORS

List of combinations

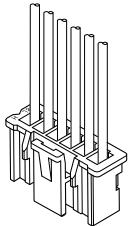
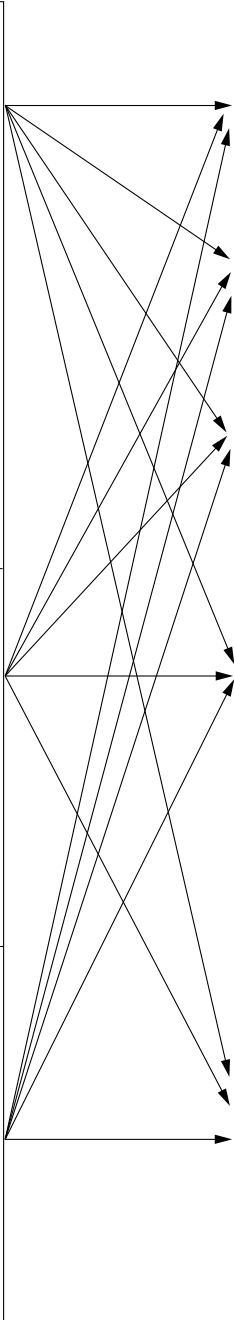
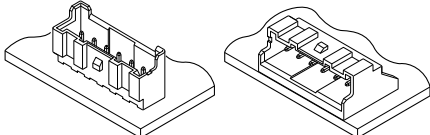
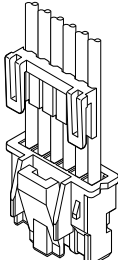
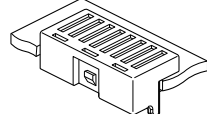
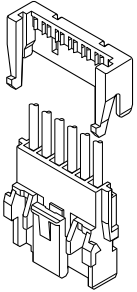
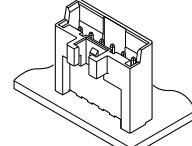
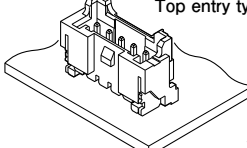
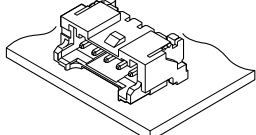
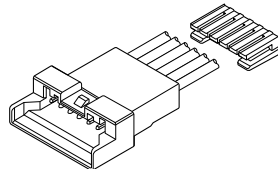
<p>Crimp style Standard type</p> 	<p><u>Contact</u> SPHD-001T-P0.5 SPHD-002T-P0.5</p> <p><u>Housing</u> PAP-()V-S</p>		<p><u>Header</u> B()B-PASK B()B-PASK-1 B()B-PASK-N B()B-PASK-1N S()B-PASK-2</p>	<p>Top entry type Side entry type</p> 
<p>Crimp style Retainer mountable type</p> 	<p><u>Contact</u> SPA-001T-P0.5</p> <p><u>Housing</u> PARP-()V</p> <p><u>Retainer</u> PMS-()V-S</p>		<p><u>Header</u> BE()B-PASK BE()B-PASK-C</p>	<p>Bottom type</p> 
<p>IDC style</p> 	<p><u>Socket</u> ()PAF-6S</p> <p><u>Retainer</u> PAFS-()V-S</p>		<p><u>Header</u> BH()B-PASK BH()B-PASK-1</p>	<p>High box type</p> 
			<p><u>Header</u> BM()B-PASS BM()B-PASS-1 SM()B-PASS SM()B-PASS-1</p>	<p>SMT type</p> <p>Top entry type</p>  <p>Side entry type</p> 
			<p><u>Contact</u> SPAL-001T-P0.5 SPAL-002T-P0.5</p> <p><u>Receptacle housing</u> PALR-()V(F)</p> <p><u>Retainer</u> PMS-()V-S</p>	<p>Wire to wire type</p> 

PA FAMILY/PA • PAF • PAL CONNECTORS

PC board layout and Assembly layout

<Through-hole type>

Top entry type

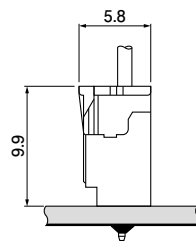
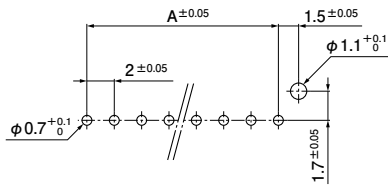

PA Socket
(Standard type)
+
PA Header

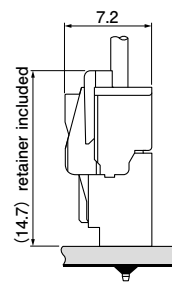

PA Socket
(Retainer mountable type)
+
PA Header

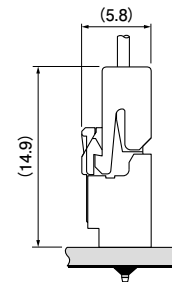

PAF Socket
+
PA Header

Side entry type

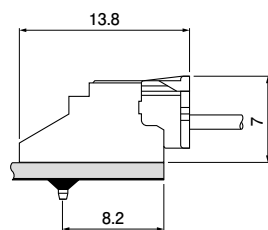
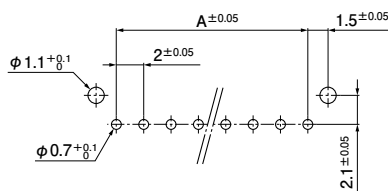

PA Socket
(Standard type)
+
PA side entry type header

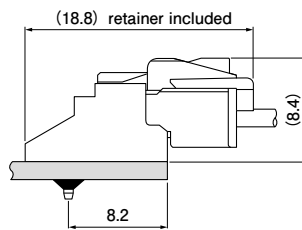

PA Socket
(Retainer mountable type)
+
PA side entry type header

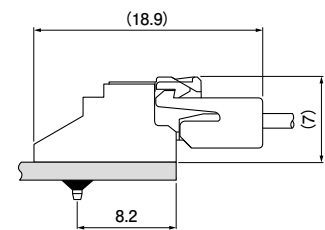

PAF Socket
+
PA side entry type header

Bottom type

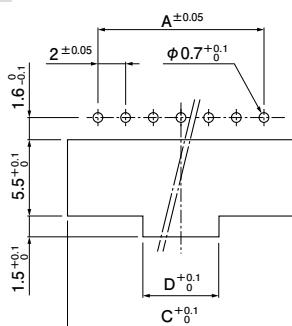

Note: Dimensions C and D; Refer to the header bottom type.

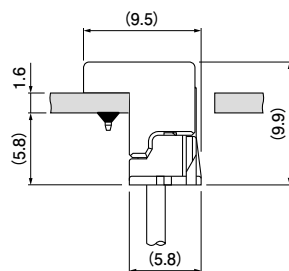

PA Socket
(Standard type)
+
PA bottom type header

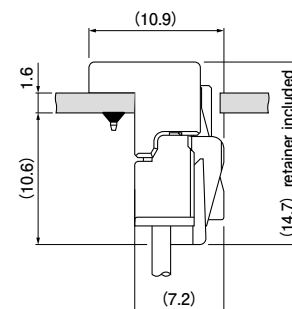

PA Socket
(Retainer mountable type)
+
PA bottom type header

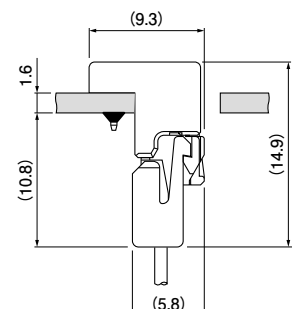

PAF Socket
+
PA bottom type header

Bottom type with extended length

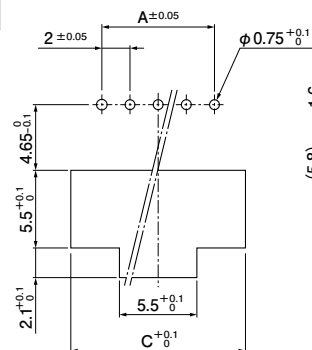

Note: Dimensions C; Refer to the header bottom type.

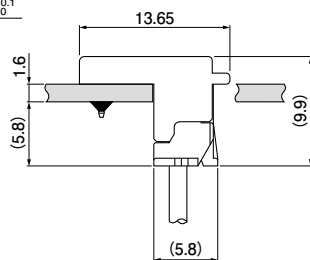

PA Socket
(Standard type)
+
PA bottom type header
(Extended length type)

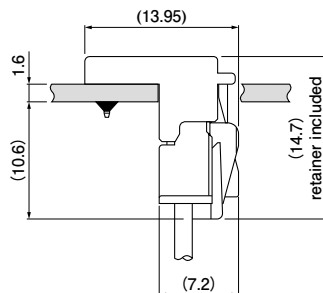

PA Socket
(Retainer mountable type)
+
PA bottom type header
(Extended length type)

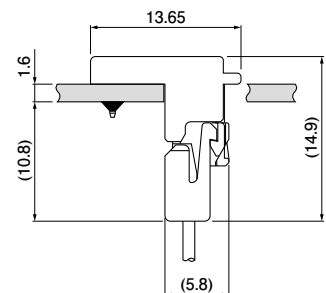

PAF Socket
+
PA bottom type header
(Extended length type)

Note: 1. The above figure is the figure viewed from the connector mounting side.

2. Tolerances are non-cumulative: ± 0.05 mm for all centers.

3. Hole dimensions differ according to the type of PC board and piercing method.

Please contact JST for details as the dimensions shown in the above figure are reference values.

PA FAMILY/PA • PAF • PAL CONNECTORS

PC board layout and Assembly layout

High box type

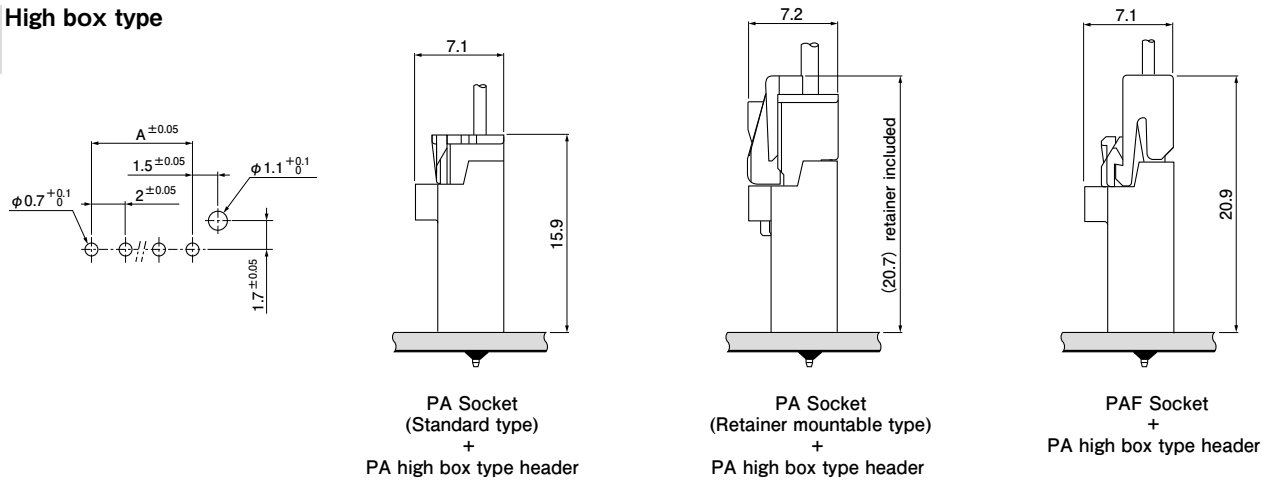

Note: 1. The above figure is the figure viewed from the connector mounting side.
 2. Tolerances are non-cumulative: ± 0.05 mm for all centers.
 3. Hole dimensions differ according to the type of PC board and piercing method.
 Please contact JST for details as the dimensions shown in the above figure are reference values.

<SMT type>

Top entry type

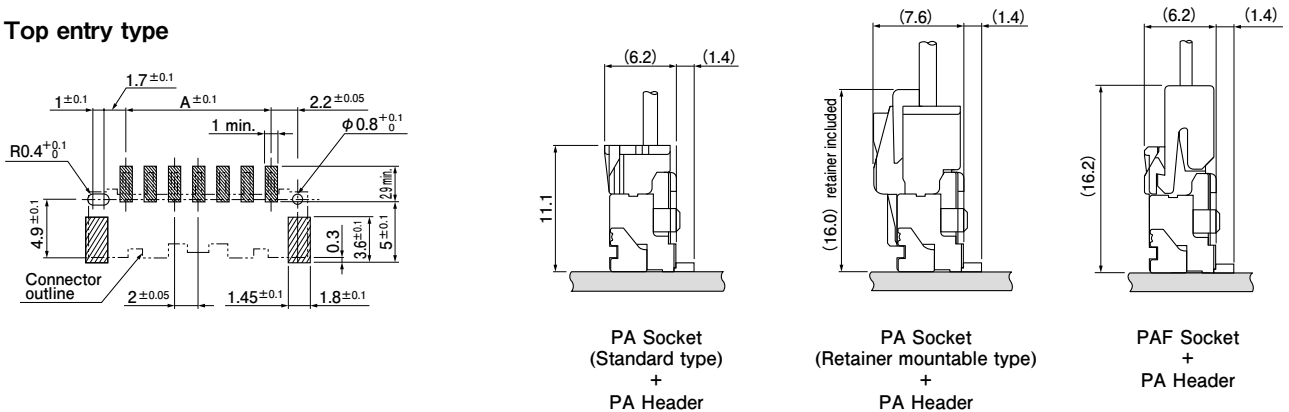

Side entry type

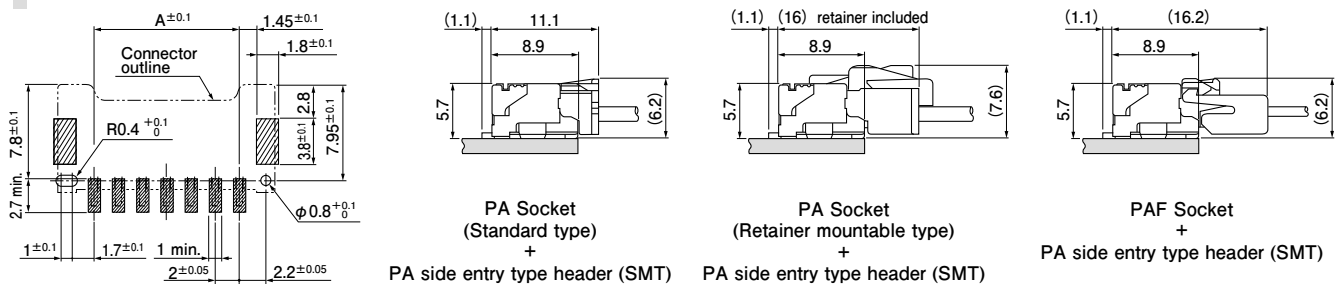

Note: 1. The above figure is the figure viewed from the connector mounting side.
 2. Tolerances for the centers of pattern on PCB is ± 0.05 , and shall be not cumulative more than ± 0.1 .
 3. Please contact JST for details as the dimensions shown in the above figure are reference values.

<Wire-to-wire>

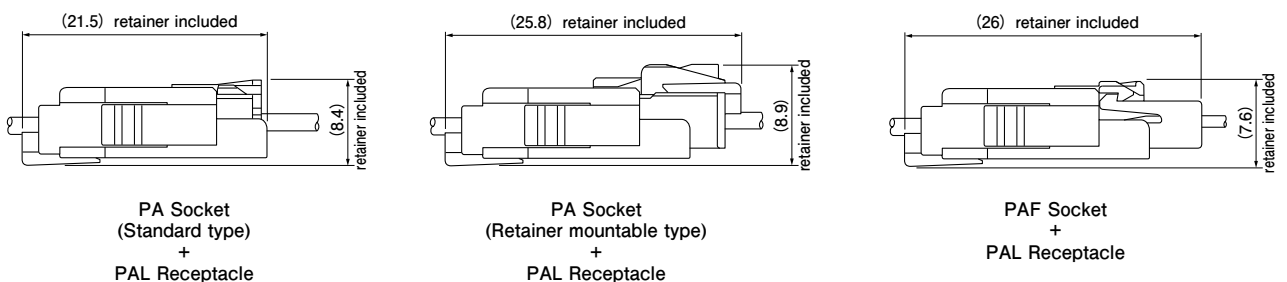

PA FAMILY/PA • PAF • PAL CONNECTORS

Contact

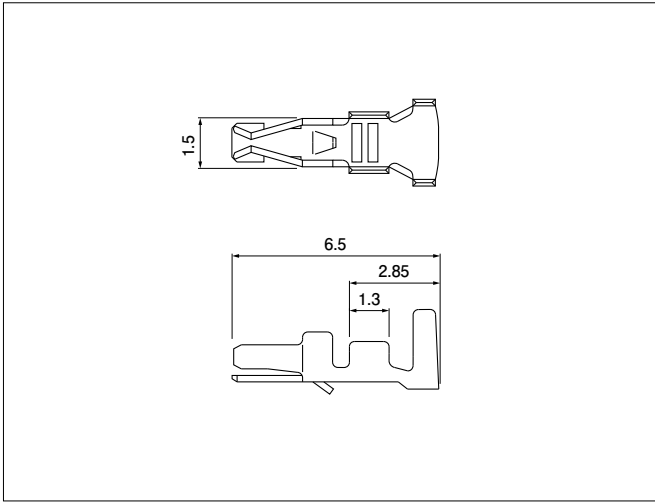

Model No.	Applicable wire		Insulation O.D. (mm)	Q'ty/reel
	mm ²	AWG #		
SPHD-001T-P0.5	0.13~0.33	26~22	1.0~1.5	8,000
SPHD-002T-P0.5	0.08~0.21	28~24	0.76~1.5	8,000

Material and Finish

Phosphor bronze, tin-plated(reflow treatment)

RoHS2 compliance

Contact	Crimping machine	Applicator		
		Crimp applicator	Dies	Crimp applicator with dies
SPHD-002T-P0.5	AP-K2N	MKS-L-10	MK/SPHD-002-05	APLMK SPHD002-05
SPHD-001T-P0.5			MK/SPHD-001-05	APLMK SPHD001-05

Note: Contact JST for fully automatic crimping applicator.

Housing

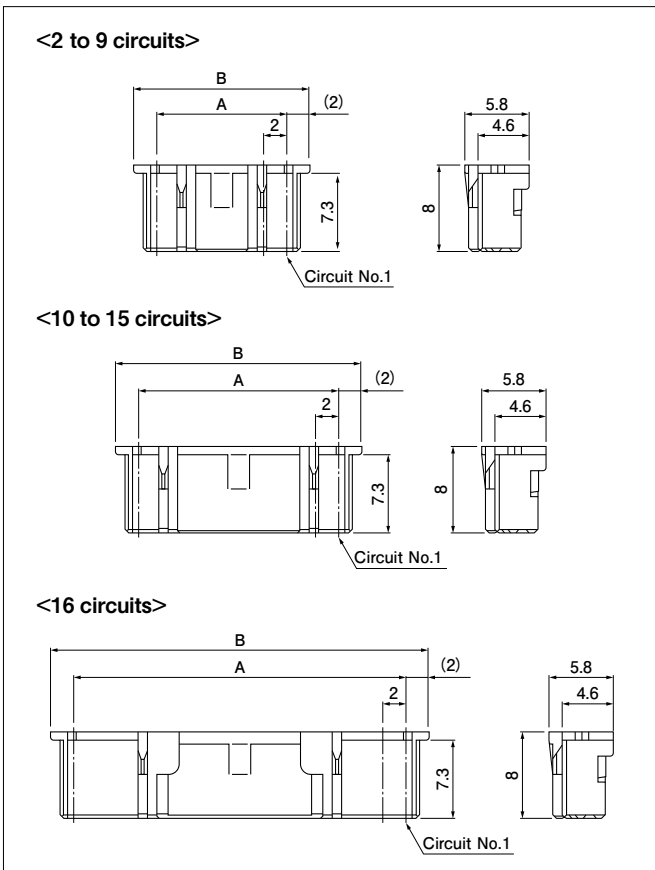

No. of circuits	Model No.	Dimensions (mm)		Q'ty/bag
		A	B	
2	PAP-02V-S	2.0	6.0	1,000
3	PAP-03V-S	4.0	8.0	1,000
4	PAP-04V-S	6.0	10.0	1,000
5	PAP-05V-S	8.0	12.0	1,000
6	PAP-06V-S	10.0	14.0	1,000
7	PAP-07V-S	12.0	16.0	1,000
8	PAP-08V-S	14.0	18.0	1,000
9	PAP-09V-S	16.0	20.0	1,000
10	PAP-10V-S	18.0	22.0	1,000
11	PAP-11V-S	20.0	24.0	1,000
12	PAP-12V-S	22.0	26.0	1,000
13	PAP-13V-S	24.0	28.0	1,000
14	PAP-14V-S	26.0	30.0	1,000
15	PAP-15V-S	28.0	32.0	1,000
16	PAP-16V-S	30.0	34.0	1,000

Material and Finish

PA 66, UL94V-0, natural (white)

RoHS2 compliance

PA FAMILY/PA • PAF • PAL CONNECTORS

Through-hole type header

Top entry type

<2 to 9 circuits>

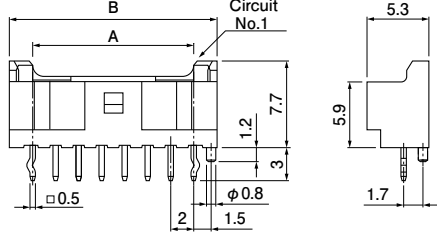

<10 to 15 circuits>

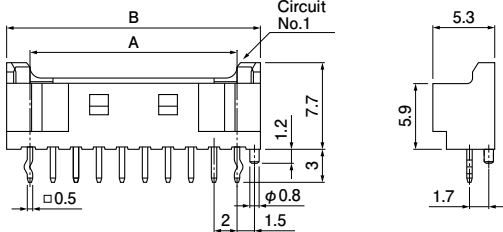

<16 circuits>

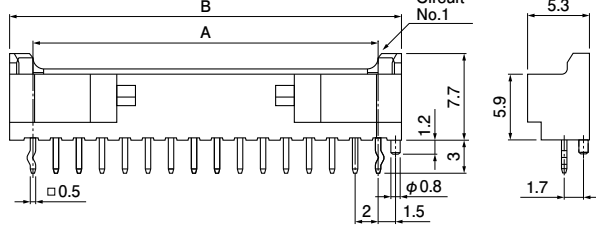

Side entry type

<2 to 9 circuits>

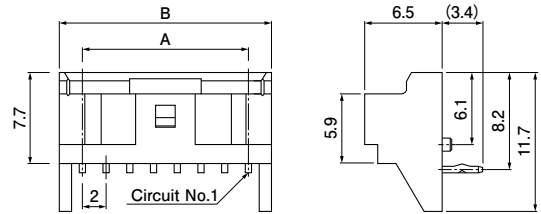

<10 to 15 circuits>

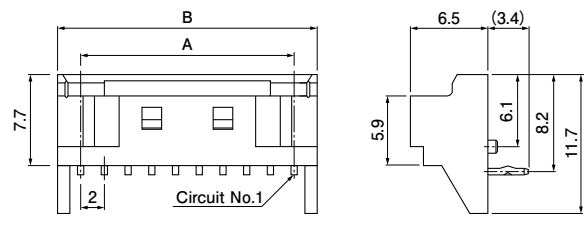

<16 circuits>

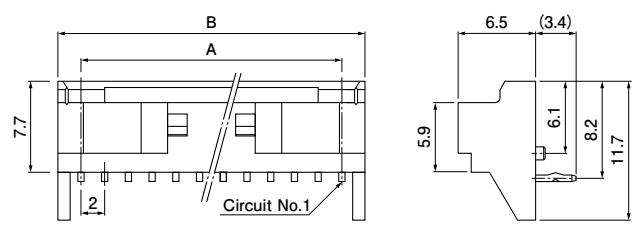

Top entry type

No. of circuits	Model No.		Dimensions (mm)		Q'ty/box
	Without boss	With a boss	A	B	
2 (Note1)	B02B-PAFYK-A	B02B-PAFYK-1A	2.0	6.0	1,000
2	B02B-PASK	B02B-PASK-1	2.0	6.0	1,000
3	B03B-PASK	B03B-PASK-1	4.0	8.0	1,000
4	B04B-PASK	B04B-PASK-1	6.0	10.0	1,000
5	B05B-PASK	B05B-PASK-1	8.0	12.0	500
6	B06B-PASK	B06B-PASK-1	10.0	14.0	500
7	B07B-PASK	B07B-PASK-1	12.0	16.0	500
8	B08B-PASK	B08B-PASK-1	14.0	18.0	500
9	B09B-PASK	B09B-PASK-1	16.0	20.0	500
10	B10B-PASK	B10B-PASK-1	18.0	22.0	500
11	B11B-PASK	B11B-PASK-1	20.0	24.0	250
12	B12B-PASK	B12B-PASK-1	22.0	26.0	250
13	B13B-PASK	B13B-PASK-1	24.0	28.0	250
14	B14B-PASK	B14B-PASK-1	26.0	30.0	250
15	B15B-PASK	B15B-PASK-1	28.0	32.0	250
16	B16B-PASK	B16B-PASK-1	30.0	34.0	250

Material and Finish

Post: Copper alloy, copper-undercoated, tin-plated (reflow treatment)
 Wafer: Glass-filled PBT, UL94V-0, natural (white)
 (Note1) PA 66, vivid yellow

RoHS2 compliance This product displays (LF)(SN) on a label.

Side entry type

No. of circuits	Model No.	Dimensions (mm)		Q'ty/box
		A	B	
2	S02B-PASK-2	2.0	6.0	1,000
3	S03B-PASK-2	4.0	8.0	1,000
4	S04B-PASK-2	6.0	10.0	500
5	S05B-PASK-2	8.0	12.0	500
6	S06B-PASK-2	10.0	14.0	500
7	S07B-PASK-2	12.0	16.0	250
8	S08B-PASK-2	14.0	18.0	250
9	S09B-PASK-2	16.0	20.0	250
10	S10B-PASK-2	18.0	22.0	250
11	S11B-PASK-2	20.0	24.0	250
12	S12B-PASK-2	22.0	26.0	250
13	S13B-PASK-2	24.0	28.0	200
14	S14B-PASK-2	26.0	30.0	200
15	S15B-PASK-2	28.0	32.0	200
16	S16B-PASK-2	30.0	34.0	200

Material and Finish

Post: Copper alloy, copper-undercoated, tin-plated (reflow treatment)
 Wafer: Glass-filled PBT, UL94V-0, natural (white)

RoHS2 compliance This product displays (LF)(SN) on a label.

PA FAMILY/PA • PAF • PAL CONNECTORS

Through-hole type header

N type

<2 to 9 circuits>

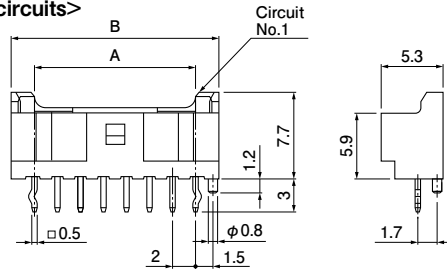

<10 to 15 circuits>

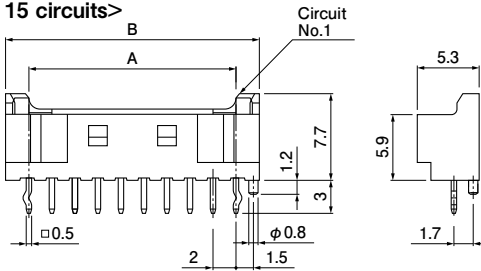

<16 circuits>

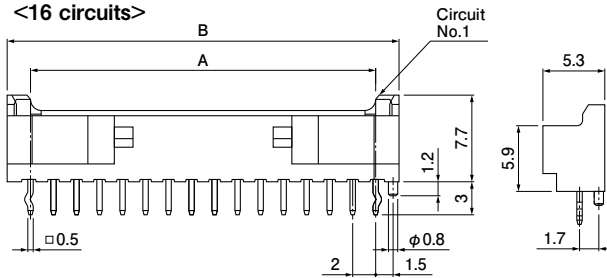

Bottom type

<5, 8 circuits>

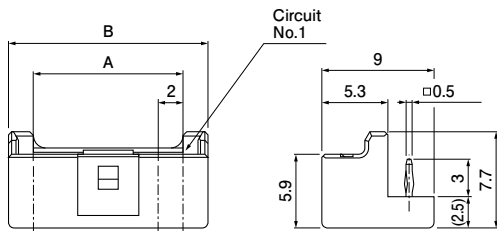

<11, 12 circuits>

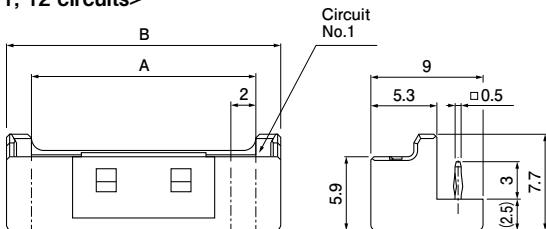

Bottom type with extended length

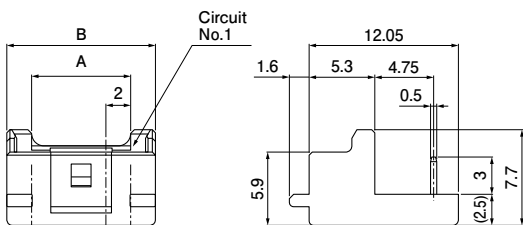

N type

No. of circuits	Model No.		Dimensions (mm)		Q'ty/box
	Without boss	With a boss	A	B	
2	B02B-PASK-N	B02B-PASK-1N	2.0	6.0	1,000
3	B03B-PASK-N	B03B-PASK-1N	4.0	8.0	1,000
4	B04B-PASK-N	B04B-PASK-1N	6.0	10.0	1,000
5	B05B-PASK-N	B05B-PASK-1N	8.0	12.0	500
6	B06B-PASK-N	B06B-PASK-1N	10.0	14.0	500
7	B07B-PASK-N	B07B-PASK-1N	12.0	16.0	500
8	B08B-PASK-N	B08B-PASK-1N	14.0	18.0	500
9	B09B-PASK-N	B09B-PASK-1N	16.0	20.0	500
10	B10B-PASK-N	B10B-PASK-1N	18.0	22.0	500
11	B11B-PASK-N	B11B-PASK-1N	20.0	24.0	250
12	B12B-PASK-N	B12B-PASK-1N	22.0	26.0	250
13	B13B-PASK-N	B13B-PASK-1N	24.0	28.0	250
14	B14B-PASK-N	B14B-PASK-1N	26.0	30.0	250
15	B15B-PASK-N	B15B-PASK-1N	28.0	32.0	250
16	B16B-PASK-N	B16B-PASK-1N	30.0	34.0	250

Material and Finish

Post: Copper alloy, copper-undercoated, tin-plated (reflow treatment)
Wafer: Glass-filled PA 66, UL94V-0, natural

RoHS2 compliance This product displays (LF)(SN) on a label.

Bottom type

No. of circuits	Model No.	Dimensions (mm)				Q'ty/bag
		A	B	C	D	
5	BE05B-PASK	8.0	12.0	12.4	5.5	300
8	BE08B-PASK	14.0	18.0	18.4	5.5	200
11	BE11B-PASK	20.0	24.0	24.4	12.0	150
12	BE12B-PASK	22.0	26.0	26.4	12.0	150

Material and Finish

Post: Copper alloy, copper-undercoated, tin-plated (reflow treatment)
Wafer: Glass-filled PBT, UL94V-0, natural

RoHS2 compliance This product displays (LF)(SN) on a label.

Note: Dimensions C and D; Refer to the PCB layout bottom type (page 3).

Bottom type with extended length

No. of circuits	Model No.	Dimensions (mm)			Q'ty/box
		A	B	C	
4	BE04B-PASK-C	6.0	10.0	10.4	1,050
5	BE05B-PASK-C	8.0	12.0	12.4	875
6	BE06B-PASK-C	10.0	14.0	14.4	750

Material and Finish

Post: Copper alloy, copper-undercoated, tin-plated (reflow treatment)
Wafer: Glass-filled PA 66, UL94V-0, natural

RoHS2 compliance This product displays (LF)(SN) on a label.

Note: 1. Dimensions C; Refer to the PCB layout bottom type (page 3).
2. Unlisted in UL.

Through-hole type header

High box type

<2 circuits>

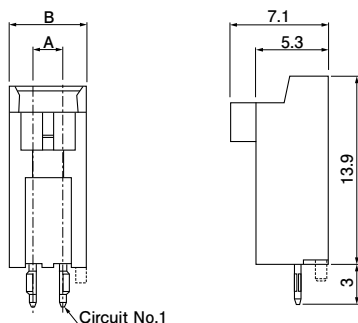

<5, 6 circuits>

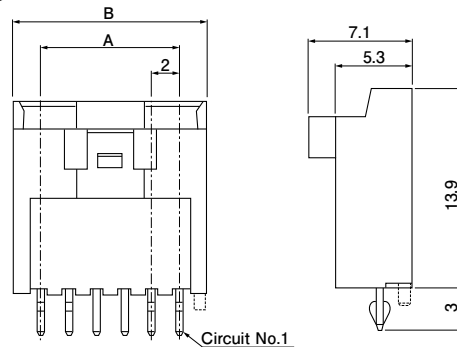

<3 circuits>

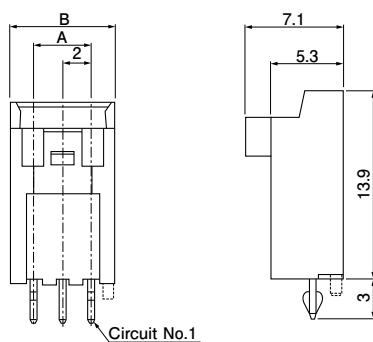

<7 to 9 circuits>

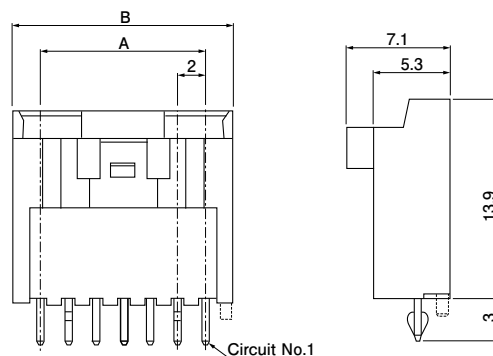

<4 circuits>

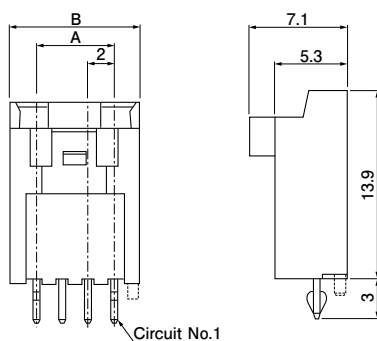

<10 to 12, 15 circuits>

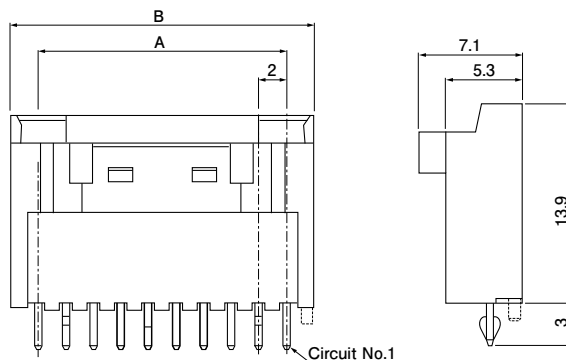

No. of circuits	Model No.		Dimensions(mm)		Q'ty/box
	Without a boss	With a boss	A	B	
2	BH02B-PASK	BH02B-PASK-1	2.0	6.0	900
3	BH03B-PASK	BH03B-PASK-1	4.0	8.0	675
4	BH04B-PASK	BH04B-PASK-1	6.0	10.0	525
5	BH05B-PASK	BH05B-PASK-1	8.0	12.0	450
6	BH06B-PASK	BH06B-PASK-1	10.0	14.0	375
7	BH07B-PASK	BH07B-PASK-1	12.0	16.0	325
8	BH08B-PASK	BH08B-PASK-1	14.0	18.0	300
9	BH09B-PASK	BH09B-PASK-1	16.0	20.0	250
10	BH10B-PASK	BH10B-PASK-1	18.0	22.0	225
11	BH11B-PASK	BH11B-PASK-1	20.0	24.0	225
12	BH12B-PASK	BH12B-PASK-1	22.0	26.0	200
15	BH15B-PASK	BH15B-PASK-1	28.0	32.0	150

Material and Finish

Post: Copper alloy, copper-undercoated, tin-plated (reflow treatment)

Wafer: Glass-filled PBT, UL94V-0, natural (white)

RoHS2 compliance This product displays (LF)(SN) on a label.

PA FAMILY/PA • PAF • PAL CONNECTORS

SMT type header

Top entry type

<2 and 3 circuits>

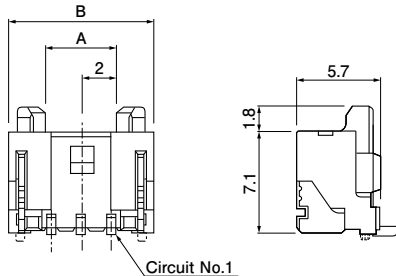

<4 to 9 circuits>

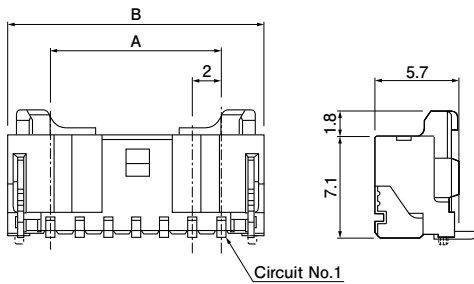

<10 to 13, 15 circuits>

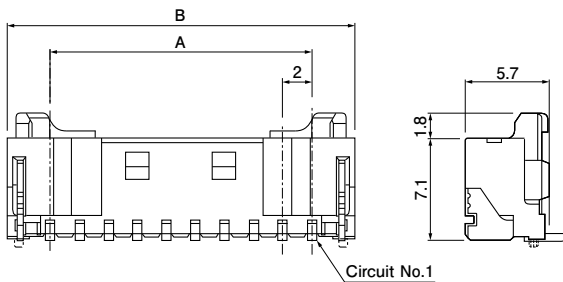

Side entry type

<2 and 3 circuits>

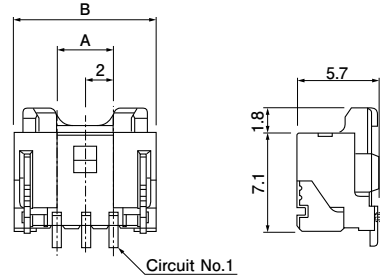

<4 to 9 circuits>

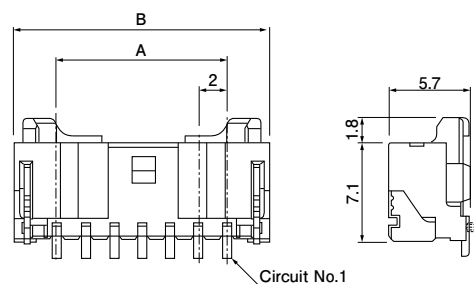

<10 to 13, 15 circuits>

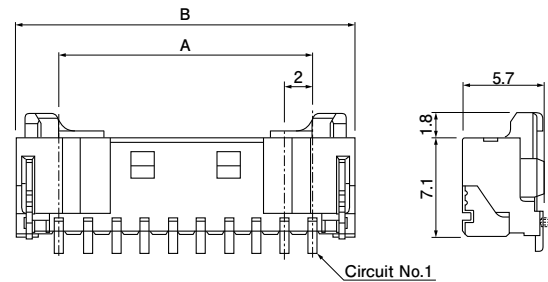

Top entry type

No. of circuits	Model No.		Dimensions(mm)		Q'ty/reel
	Without a boss	With a boss	A	B	
2	BM02B-PASS-(*)	BM02B-PASS-1-(*)	2.0	8.0	500
3	BM03B-PASS-(*)	BM03B-PASS-1-(*)	4.0	10.0	500
4	BM04B-PASS-(*)	BM04B-PASS-1-(*)	6.0	12.0	500
5	BM05B-PASS-(*)	BM05B-PASS-1-(*)	8.0	14.0	500
6	BM06B-PASS-(*)	BM06B-PASS-1-(*)	10.0	16.0	500
7	BM07B-PASS-(*)	BM07B-PASS-1-(*)	12.0	18.0	500
8	BM08B-PASS-(*)	BM08B-PASS-1-(*)	14.0	20.0	500
9	BM09B-PASS-(*)	BM09B-PASS-1-(*)	16.0	22.0	500
10	BM10B-PASS-(*)	BM10B-PASS-1-(*)	18.0	24.0	500
11	BM11B-PASS-(*)	BM11B-PASS-1-(*)	20.0	26.0	500
12	BM12B-PASS-(*)	BM12B-PASS-1-(*)	22.0	28.0	500
13	BM13B-PASS-(*)	BM13B-PASS-1-(*)	24.0	30.0	500
15	BM15B-PASS-(*)	BM15B-PASS-1-(*)	28.0	34.0	500

Material and Finish

Post: Copper alloy, copper-undercoated, tin-plated (reflow treatment)
 Wafer: PA, UL94V-0, natural (ivory)
 Solder tab: Copper alloy, copper-undercoated, tin-plated (reflow treatment)

RoHS2 compliance This product displays (LF)(SN) on a label.

Note: (*) : TF...taping product

TFT...taping product with suction tape.

Side entry type

No. of circuits	Model No.		Dimensions(mm)		Q'ty/reel
	Without a boss	With a boss	A	B	
2	SM02B-PASS-(*)	SM02B-PASS-1-(*)	2.0	8.0	1,000
3	SM03B-PASS-(*)	SM03B-PASS-1-(*)	4.0	10.0	1,000
4	SM04B-PASS-(*)	SM04B-PASS-1-(*)	6.0	12.0	1,000
5	SM05B-PASS-(*)	SM05B-PASS-1-(*)	8.0	14.0	1,000
6	SM06B-PASS-(*)	SM06B-PASS-1-(*)	10.0	16.0	1,000
7	SM07B-PASS-(*)	SM07B-PASS-1-(*)	12.0	18.0	1,000
8	SM08B-PASS-(*)	SM08B-PASS-1-(*)	14.0	20.0	1,000
9	SM09B-PASS-(*)	SM09B-PASS-1-(*)	16.0	22.0	1,000
10	SM10B-PASS-(*)	SM10B-PASS-1-(*)	18.0	24.0	1,000
11	SM11B-PASS-(*)	SM11B-PASS-1-(*)	20.0	26.0	1,000
12	SM12B-PASS-(*)	SM12B-PASS-1-(*)	22.0	28.0	1,000
13	SM13B-PASS-(*)	SM13B-PASS-1-(*)	24.0	30.0	1,000
15	SM15B-PASS-(*)	SM15B-PASS-1-(*)	28.0	34.0	1,000

Material and Finish

Post: Copper alloy, copper-undercoated, tin-plated (reflow treatment)
 Wafer: PA, UL94V-0, natural (ivory)
 Solder tab: Copper alloy, copper-undercoated, tin-plated (reflow treatment)

RoHS2 compliance This product displays (LF)(SN) on a label.

Note: (*) : TB...taping product

TBT...taping product with suction tape.

PA FAMILY/PA • PAF • PAL CONNECTORS

Contact

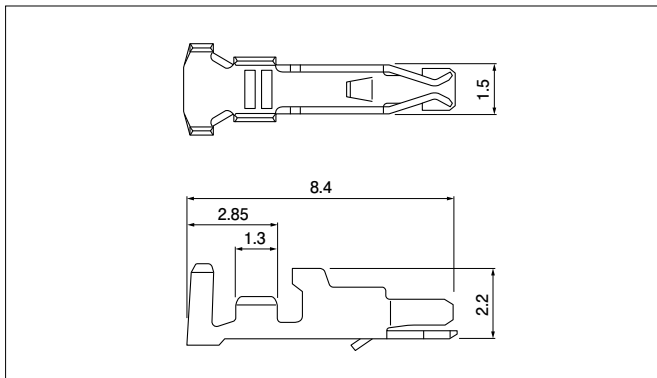

Model No.	Applicable wire		Insulation O.D. (mm)	Q'ty/reel
	mm ²	AWG #		
SPA-001T-P0.5	0.13~0.33	26~22	0.9~1.5	10,000

Material and Finish

Phosphor bronze, tin-plated (reflow treatment)

RoHS2 compliance

Contact	Crimping machine	Applicator		
		Crimp applicator	Dies	Crimp applicator with dies
SPA-001T-P0.5	AP-K2N	MKS-L	MK/SPA-001-05	APLMK SPA001-05

Note: Contact JST for fully automatic crimping applicator.

Housing

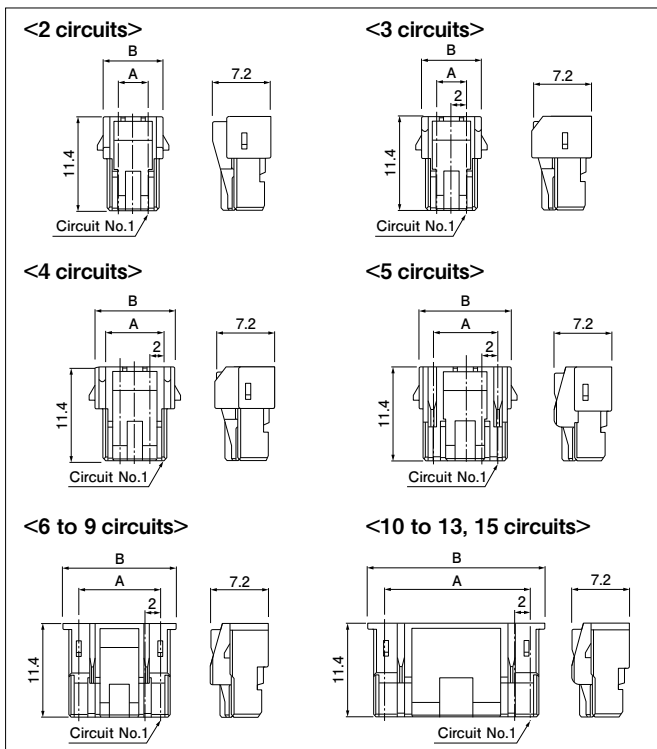

No. of circuits	Model No.	Dimensions (mm)		Q'ty/bag
		A	B	
2	PARP-02V	2.0	5.4	1,000
3	PARP-03V	4.0	7.4	1,000
4	PARP-04V	6.0	9.4	1,000
5	PARP-05V	8.0	11.4	1,000
6	PARP-06V	10.0	14.0	1,000
7	PARP-07V	12.0	16.0	1,000
8	PARP-08V	14.0	18.0	1,000
9	PARP-09V	16.0	20.0	1,000
10	PARP-10V	18.0	22.0	1,000
11	PARP-11V	20.0	24.0	500
12	PARP-12V	22.0	26.0	500
13	PARP-13V	24.0	28.0	500
15	PARP-15V	28.0	32.0	500

Material and Finish

PA 66, UL94V-0, natural (white)

RoHS2 compliance

Note: Contact JST for Glow Wire compliant connectors.

Retainer

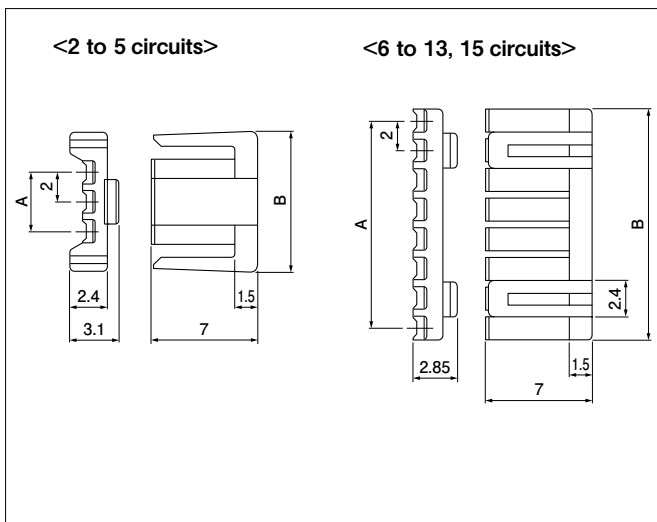

No. of circuits	Model No.	Dimensions (mm)		Q'ty/bag
		A	B	
2	PMS-02V-S	2.0	7.3	1,000
3	PMS-03V-S	4.0	9.3	1,000
4	PMS-04V-S	6.0	11.3	1,000
5	PMS-05V-S	8.0	13.3	1,000
6	PMS-06V-S	10.0	11.55	1,000
7	PMS-07V-S	12.0	13.55	1,000
8	PMS-08V-S	14.0	15.55	1,000
9	PMS-09V-S	16.0	17.55	1,000
10	PMS-10V-S	18.0	19.55	1,000
11	PMS-11V-S	20.0	21.55	1,000
12	PMS-12V-S	22.0	23.55	1,000
13	PMS-13V-S	24.0	25.55	1,000
15	PMS-15V-S	28.0	29.55	1,000

Material and Finish

Glass-filled PA 66, UL94V-0, natural (ivory)

RoHS2 compliance

PA FAMILY/PA • PAF • PAL CONNECTORS

Receptacle

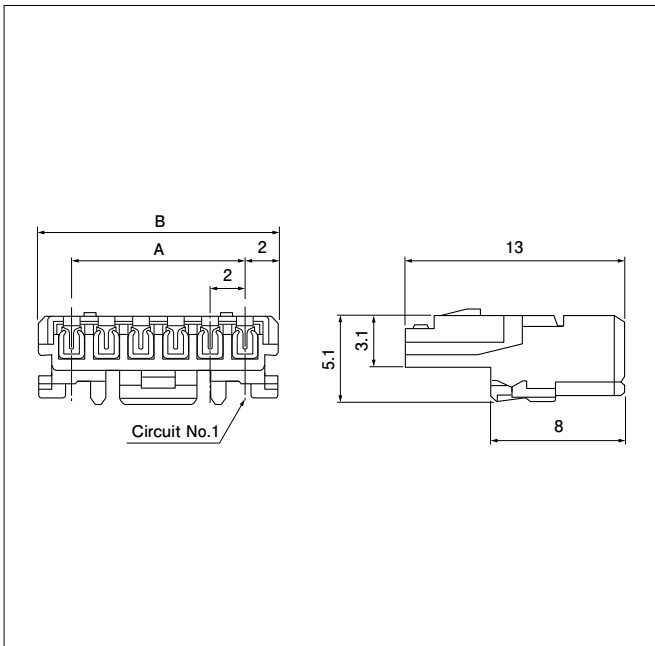

No. of circuits	Model No.	Dimensions (mm)		Q'ty/box
		A	B	
2	02PAF-6S	2.0	6.0	1,000
3	03PAF-6S	4.0	8.0	1,000
4	04PAF-6S	6.0	10.0	500
5	05PAF-6S	8.0	12.0	500
6	06PAF-6S	10.0	14.0	500
7	07PAF-6S	12.0	16.0	500
8	08PAF-6S	14.0	18.0	250
9	09PAF-6S	16.0	20.0	250
10	10PAF-6S	18.0	22.0	250
11	11PAF-6S	20.0	24.0	250
12	12PAF-6S	22.0	26.0	250
13	13PAF-6S	24.0	28.0	250
14	14PAF-6S	26.0	30.0	250
15	15PAF-6S	28.0	32.0	250
*16	16PAF-6S	30.0	34.0	250

Material and Finish

Contact: Phosphor bronze, tin-plated (reflow treatment)

Housing: PA 66, UL94V-0, natural (white)

RoHS2 compliance
Note*: Unlisted in UL.

Retainer

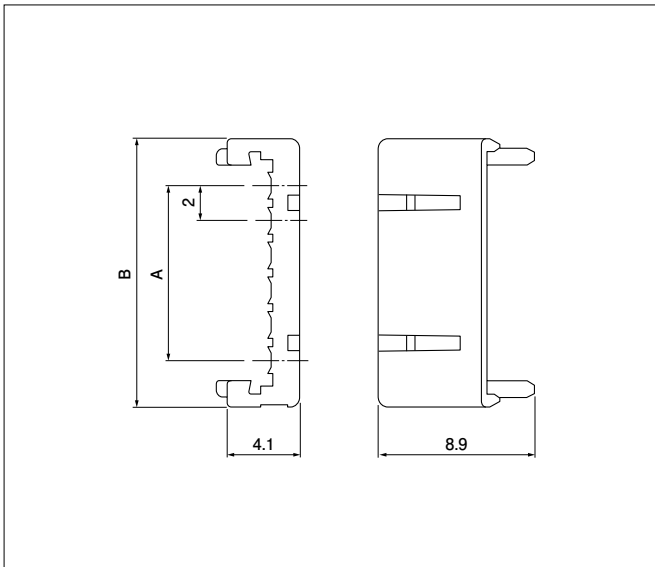

No. of circuits	Model No.	Dimensions (mm)		Q'ty/bag
		A	B	
2	PAFS-02V-S	2.0	7.4	1,000
3	PAFS-03V-S	4.0	9.4	1,000
4	PAFS-04V-S	6.0	11.4	1,000
5	PAFS-05V-S	8.0	13.4	1,000
6	PAFS-06V-S	10.0	15.4	1,000
7	PAFS-07V-S	12.0	17.4	1,000
8	PAFS-08V-S	14.0	19.4	1,000
* 9	PAFS-09V-S	16.0	21.4	1,000
*10	PAFS-10V-S	18.0	23.4	1,000
*11	PAFS-11V-S	20.0	25.4	1,000
*12	PAFS-12V-S	22.0	27.4	1,000
*13	PAFS-13V-S	24.0	29.4	1,000
*14	PAFS-14V-S	26.0	31.4	1,000
*15	PAFS-15V-S	28.0	33.4	1,000

Material and Finish

Glass-filled PA 66, UL94V-0, natural (ivory)

RoHS2 compliance
Note*: Unlisted in UL.

PA FAMILY/PA • PAF • PAL CONNECTORS

Contact

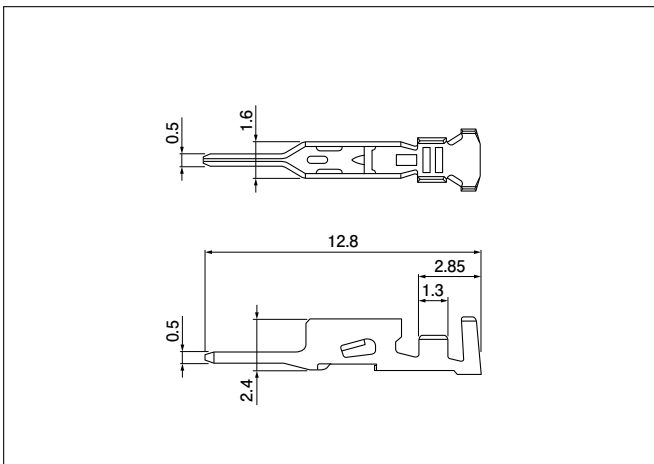

Model No.	Applicable wire		Insulation O.D. (mm)	Q'ty/reel
	mm ²	AWG #		
SPAL-001T-P0.5	0.13~0.33	26~22	1.0~1.5	10,000
SPAL-002T-P0.5	0.08~0.21	28~24	0.9~1.5	10,000

Material and Finish

Phosphor bronze, tin-plated (reflow treatment)

RoHS2 compliance

Contact	Crimping machine	Applicator		
		Crimp applicator	Dies	Crimp applicator with dies
SPAL-001T-P0.5	AP-K2N	MKS-L	MK/SPAL-001-05	APLMK SPAL001-05
SPAL-002T-P0.5			MK/SPAL-002-05	APLMK SPAL002-05

Note: Contact JST for fully automatic crimping applicator.

Housing

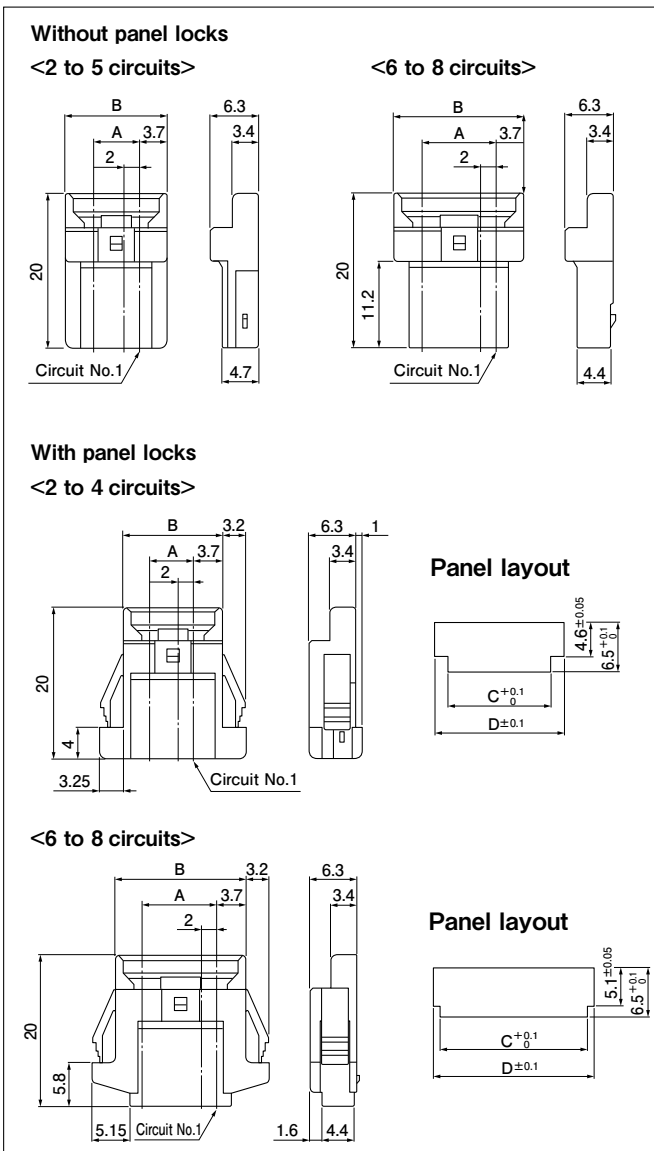

No. of circuits	Model No.	Dimensions (mm)		Q'ty/bag
		A	B	
2	PALR-02VF	2.0	9.4	1,000
3	PALR-03VF	4.0	11.4	1,000
4	PALR-04VF	6.0	13.4	1,000
5	PALR-05VF	8.0	15.4	1,000
6	PALR-06VF	10.0	17.4	1,000
7	PALR-07VF	12.0	19.4	1,000
8	PALR-08VF	14.0	21.4	1,000

Material and Finish

PA 66, UL94V-0, natural (white)

RoHS2 compliance

No. of circuits	Model No.	Dimensions (mm)				Q'ty/bag
		A	B	C	D	
2	PALR-02V	2.0	9.4	9.8	13.4	1,000
3	PALR-03V	4.0	11.4	11.8	15.4	1,000
4	PALR-04V	6.0	13.4	13.8	17.4	1,000
6	PALR-06V	10.0	17.4	19.8	21.4	1,000
7	PALR-07V	12.0	19.4	21.8	23.4	1,000
8	PALR-08V	14.0	21.4	23.8	25.4	1,000

Material and Finish

PA 66, UL94V-0, natural (white)

RoHS2 compliance

Retainer

Retainers are interchangeable with those of the PA crimp style retainer mountable type.

PA FAMILY/PA • PAF • PAL CONNECTORS

Model number allocation

Contact (Standard type)

S PHD - 002 T - P 0.5

Form: S...Strip form, B...Loose piece

Series name

Applicable wire range: 002...AWG #28 to #24
001...AWG #26 to #22

Surface finish: T...Tin-plated (reflow treatment)

Material: P...Phosphor bronze

Terminal size

Housing (Standard type)

PA P - 02 V - S

Series name

Part name: Plug

No. of circuits: 2 to 16

Flammability: V...UL94V-0

Color: S...Natural (White), K...Black, R...Red, E...Blue, M...Green,
O...Orange, N...Brown, P...Purple, PK...Pink, Y...Yellow,
L...Lemon yellow, FY...Fluorescent yellow, LE...Light blue,
H...Gray, TR...Tomato red

Contact (Retainer mountable type)

S PA - 001 T - P 0.5

Form: S...Strip form

Series name

Applicable wire range: 001...AWG #26 to #22

Surface finish: T...Tin-plated (reflow treatment)

Material: P...Phosphor bronze

Terminal size

Housing (Retainer mountable type)

PA RP - 02 V - ■

Series name

Part name: Plug (Retainer mountable type)

No. of circuits: 2 to 13, 15

Flammability: V...UL94V-0

Color: None...Natural (White), R...Red, E...Blue, M...Green, Y...Yellow

Retainer (Crimp style)

PM S - 02 V - S

Series name

Part name: S...Retainer

No. of circuits: 2 to 13, 15

Flammability: V...UL94V-0

Color: S...Natural (Ivory)

Socket (IDC style)

02 PAF - 6 S

No. of circuits: 2 to 16

Series name

Applicable wire range: 6...AWG #26

Color: S...Natural (White), R...Red, E...Blue, M...Green, Y...Yellow

Retainer (IDC style)

PAF S - 02 V - S

Series name

Part name: S...Retainer

No. of circuits: 2 to 15

Flammability: V...UL94V-0

Color: S...Natural (Ivory)

PA FAMILY/PA • PAF • PAL CONNECTORS

Model number allocation

Header (Top entry type)

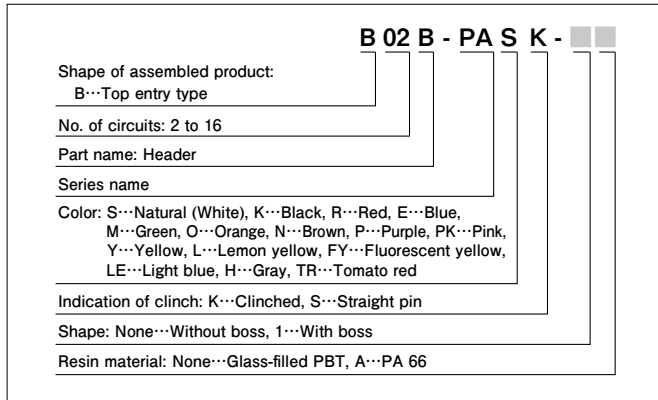

Header (Side entry type)

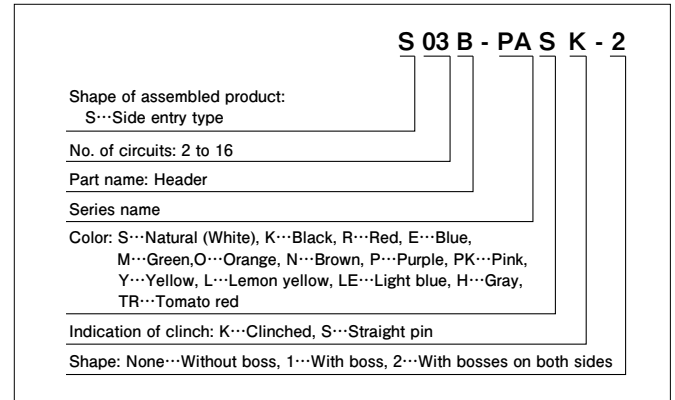

Header (Top entry type, N type)

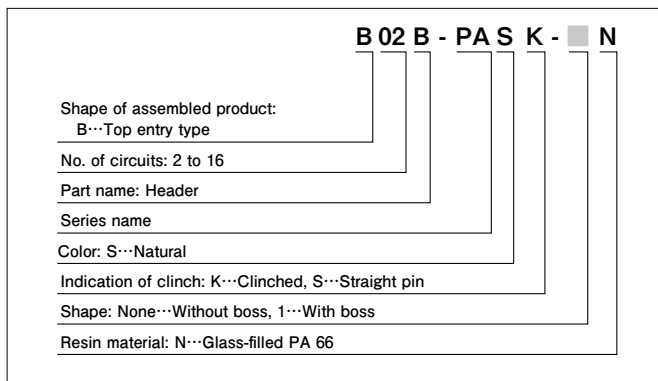

Header (Bottom type, Bottom type with extended length)

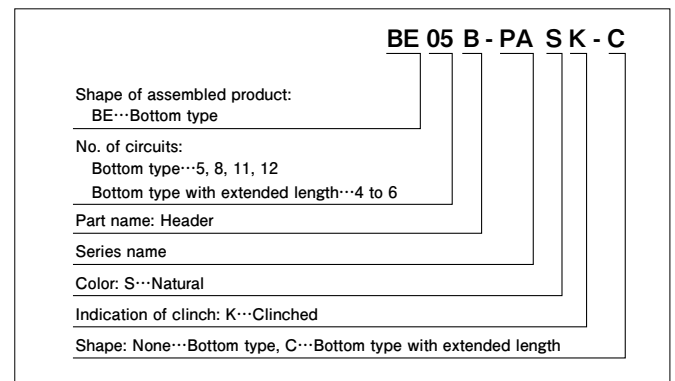

Header (High box type)

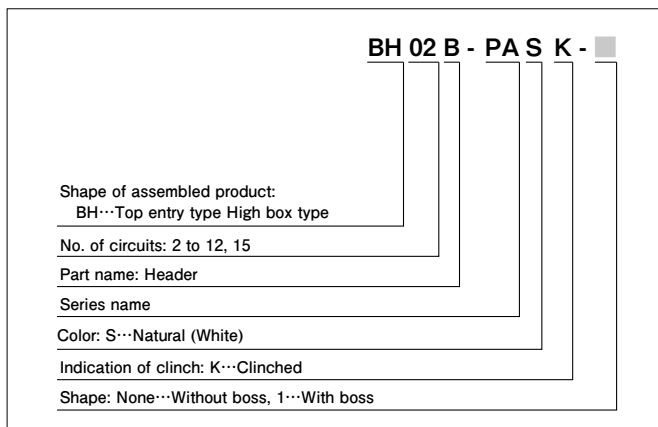

Header (SMT type)

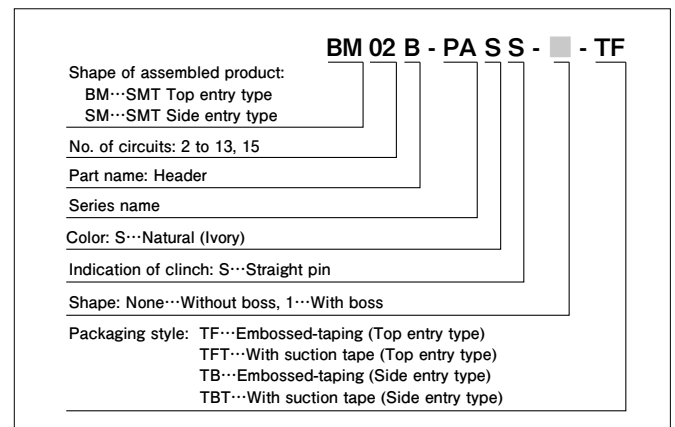

Pin contact for wire to wire

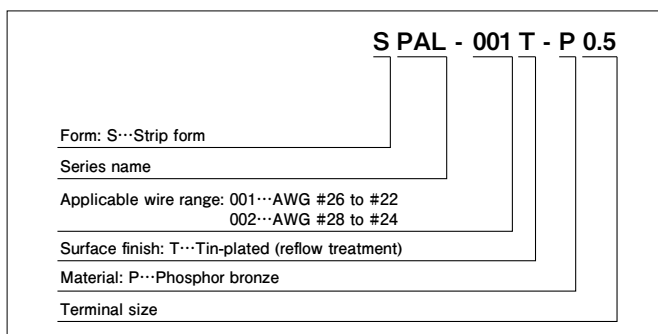

Receptacle housing for wire-to-wire

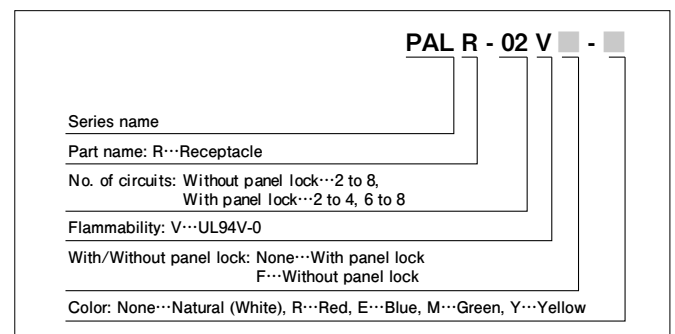

单击下面可查看定价，库存，交付和生命周期等信息

[>>JST\(杰世腾\)](#)