

# NSH CONNECTOR

1.0 mm pitch/Disconnectable Crimp style connectors

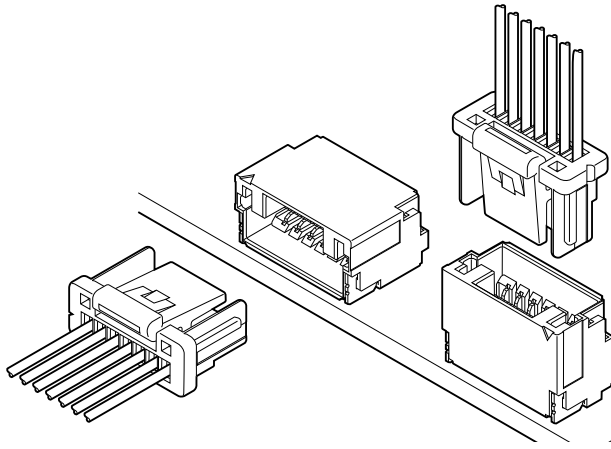

**1.0 mm pitch secure lock type connector.** This low insertion force type connector realizes easier mating operation. The basic concept of the contact part of this connector is equivalent to the performance proven SHL connector.

- Secure locking structure
- Contact lock structure
- Prevention of contact deformation
- Clear engagement click sounds

## Specifications

- Current rating: 1.0 A AC/DC (AWG #28)
- Voltage rating: 50 V AC/DC
- Temperature range: -25°C to +85°C  
(including temperature rise in applying electrical current)
- Contact resistance: Initial value/ 30 mΩ max.  
After environmental tests/ 50 mΩ max.
- Insulation resistance: 100 MΩ min.
- Withstanding voltage: 500 VAC/minute
- Applicable wire: Conductor size/ AWG #32 to #28  
Insulation O.D./ 0.4 to 0.8 mm

\* In using the products, refer to "Handling Precautions for Terminals and Connectors" described on our website (Technical documents of Product information page).

- \* RoHS2 compliance
- \* Dimensional unit: mm
- \* Contact JST for details.

## Standards

Ⓜ Recognized E60389

## PC board layout and Assembly layout

### Top entry type

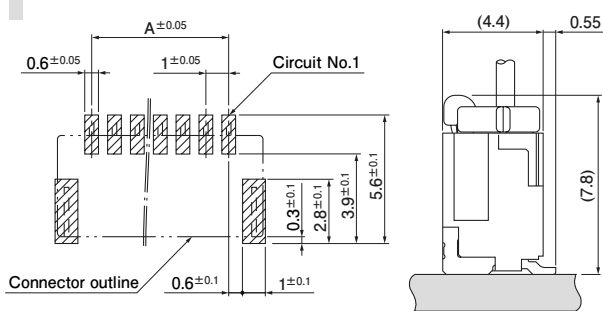

### Side entry type

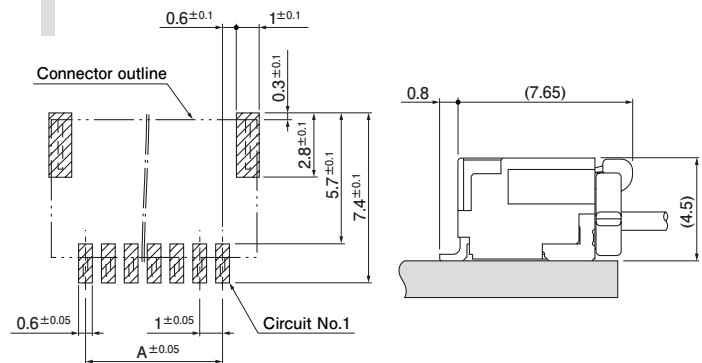

- Note: 1. The above figure is the figure viewed from the connector mounting side.  
2. Tolerances are non-cumulative: ± 0.05 mm for all centers.  
3. The dimensions above should serve as a guideline. Contact JST for details.

## Contact

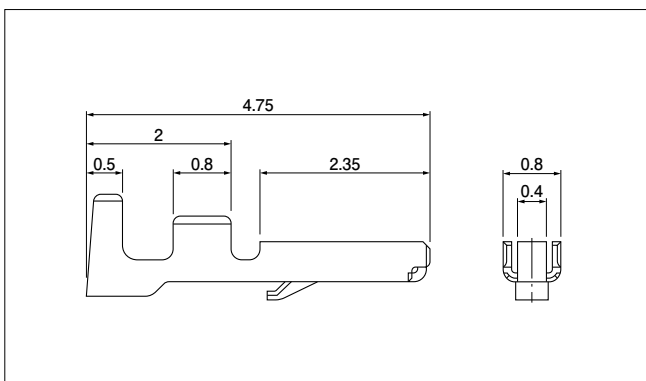

Model No.	Applicable wire		Insulation O.D. (mm)	Q'ty/reel
	mm <sup>2</sup>	AWG#		
SSH-003T-P0.2	0.032 to 0.08	32 to 28	0.4 to 0.8	41,000

### Material and Finish

Phosphor bronze, tin-plated (reflow treatment)

### RoHS2 compliance

Contact	Crimping machine	Applicator		
		Crimp applicator	Dies	Crimp applicator with dies
SSH-003T-P0.2	AP-K2N	MKS-L-10-3	MK/SSH/L-003-02	APLMK SSH/L003-02

Note: Contact JST for fully automatic crimping applicator.

# NSH CONNECTOR

## Housing

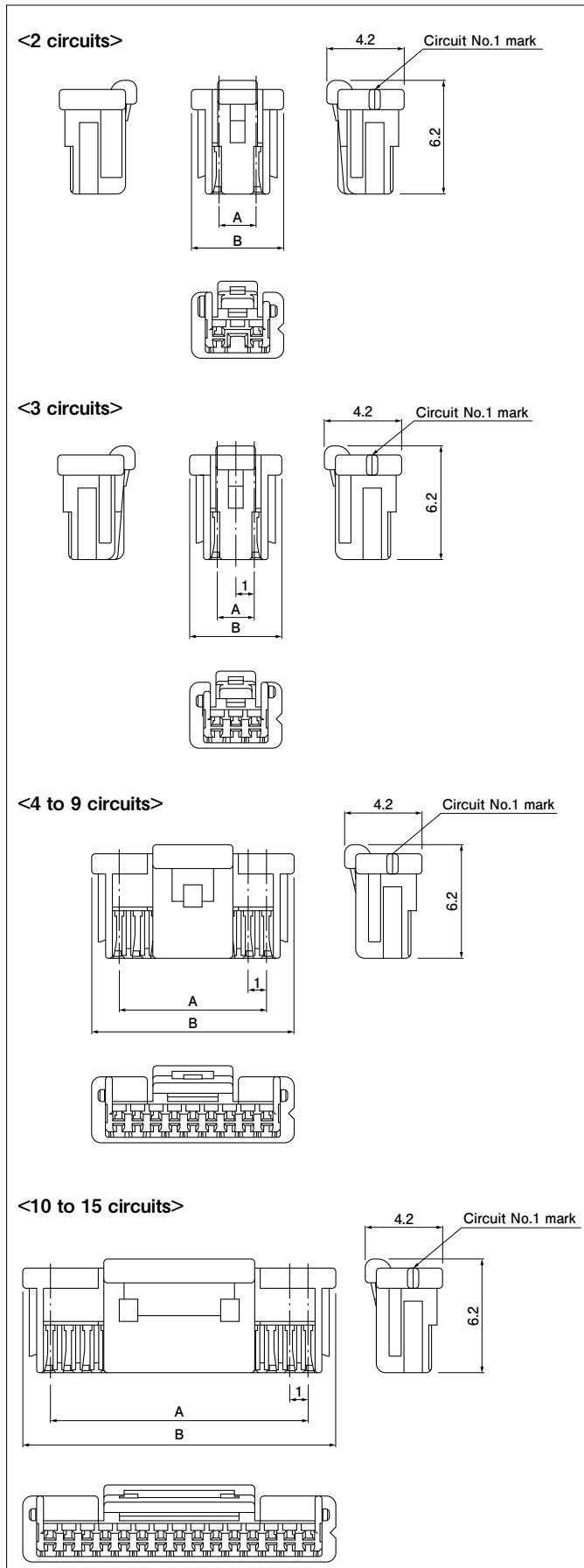

No. of circuits	Model No.	Dimensions (mm)		Q'ty/ bag
		A	B	
2	NSHR-02V-S	*2.0	*5.0	3,000
3	NSHR-03V-S	2.0	5.0	3,000
4	NSHR-04V-S	3.0	6.0	2,500
5	NSHR-05V-S	4.0	7.0	2,000
6	NSHR-06V-S	5.0	8.0	1,500
7	NSHR-07V-S	6.0	9.0	1,500
8	NSHR-08V-S	7.0	10.0	1,500
9	NSHR-09V-S	8.0	11.0	1,000
10	NSHR-10V-S	9.0	12.0	1,000
11	NSHR-11V-S	10.0	13.0	1,000
12	NSHR-12V-S	11.0	14.0	1,000
13	NSHR-13V-S	12.0	15.0	1,000
14	NSHR-14V-S	13.0	16.0	1,000
15	NSHR-15V-S	14.0	17.0	1,000

### Material and Finish

PBT, UL94V-0, natural

### RoHS2 compliance

Note: 2 circuits product is that the second pin of 3 circuits product is plugged up. (Between circuits 2.0mm pitch)

# NSH CONNECTOR

## Header

### Top entry type

<2 circuits>

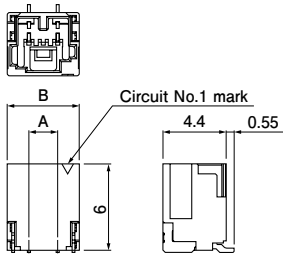

<3 circuits>

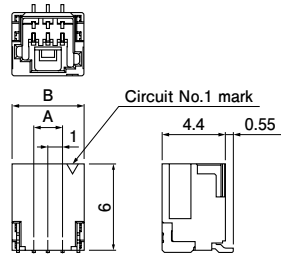

<4 to 9 circuits>

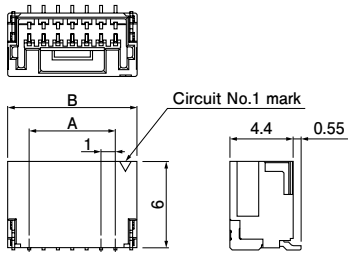

<10 to 15 circuits>

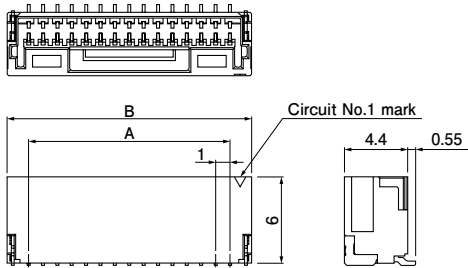

### Side entry type

<2 circuits>

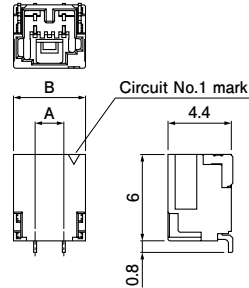

<3 circuits>

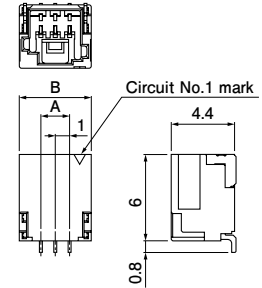

<4 to 9 circuits>

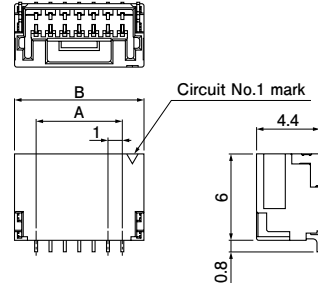

<10 to 15 circuits>

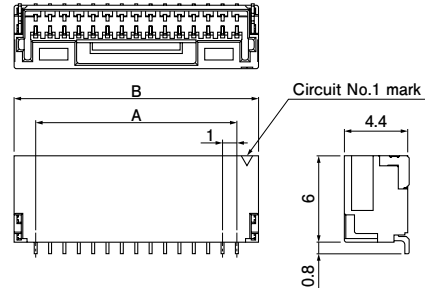

### Top entry type

No. of circuits	Model No.	Dimensions (mm)		Q'ty/ reel
		A	B	
2	BM02B-NSHSS-TBT	*2.0	*5.0	1,000
3	BM03B-NSHSS-TBT	2.0	5.0	1,000
4	BM04B-NSHSS-TBT	3.0	6.0	1,000
5	BM05B-NSHSS-TBT	4.0	7.0	1,000
6	BM06B-NSHSS-TBT	5.0	8.0	1,000
7	BM07B-NSHSS-TBT	6.0	9.0	1,000
8	BM08B-NSHSS-TBT	7.0	10.0	1,000
9	BM09B-NSHSS-TBT	8.0	11.0	1,000
10	BM10B-NSHSS-TBT	9.0	12.0	1,000
11	BM11B-NSHSS-TBT	10.0	13.0	1,000
12	BM12B-NSHSS-TBT	11.0	14.0	1,000
13	BM13B-NSHSS-TBT	12.0	15.0	1,000
14	BM14B-NSHSS-TBT	13.0	16.0	1,000
15	BM15B-NSHSS-TBT	14.0	17.0	1,000

#### Material and Finish

Contact: Copper alloy, copper-undercoated, tin-plated (reflow treatment)  
 Wafer: Polyamide, UL94V-0, natural  
 Reinforcement: Copper alloy, copper-undercoated, tin-plated (reflow treatment)

**RoHS2 compliance** This product displays (LF)(SN) on a label.  
 Note: 1. The products listed above are supplied on embossed-tape/with suction tape.  
 2. 2 circuits product is that the second pin of 3 circuits product is plugged up. (Between circuits 2.0 mm pitch)

### Side entry type

No. of circuits	Model No.	Dimensions (mm)		Q'ty/ reel
		A	B	
2	SM02B-NSHSS-TB	*2.0	*5.0	1,500
3	SM03B-NSHSS-TB	2.0	5.0	1,500
4	SM04B-NSHSS-TB	3.0	6.0	1,500
5	SM05B-NSHSS-TB	4.0	7.0	1,500
6	SM06B-NSHSS-TB	5.0	8.0	1,500
7	SM07B-NSHSS-TB	6.0	9.0	1,500
8	SM08B-NSHSS-TB	7.0	10.0	1,500
9	SM09B-NSHSS-TB	8.0	11.0	1,500
10	SM10B-NSHSS-TB	9.0	12.0	1,500
11	SM11B-NSHSS-TB	10.0	13.0	1,500
12	SM12B-NSHSS-TB	11.0	14.0	1,500
13	SM13B-NSHSS-TB	12.0	15.0	1,500
14	SM14B-NSHSS-TB	13.0	16.0	1,500
15	SM15B-NSHSS-TB	14.0	17.0	1,500

#### Material and Finish

Contact: Copper alloy, copper-undercoated, tin-plated (reflow treatment)  
 Wafer: Polyamide, UL94V-0, natural  
 Reinforcement: Copper alloy, copper-undercoated, tin-plated (reflow treatment)

**RoHS2 compliance** This product displays (LF)(SN) on a label.  
 Note: 1. The products listed above are supplied on embossed-tape/without suction tape.  
 2. 2 circuits product is that the second pin of 3 circuits product is plugged up. (Between circuits 2.0 mm pitch)

## Model number allocation

### Contact

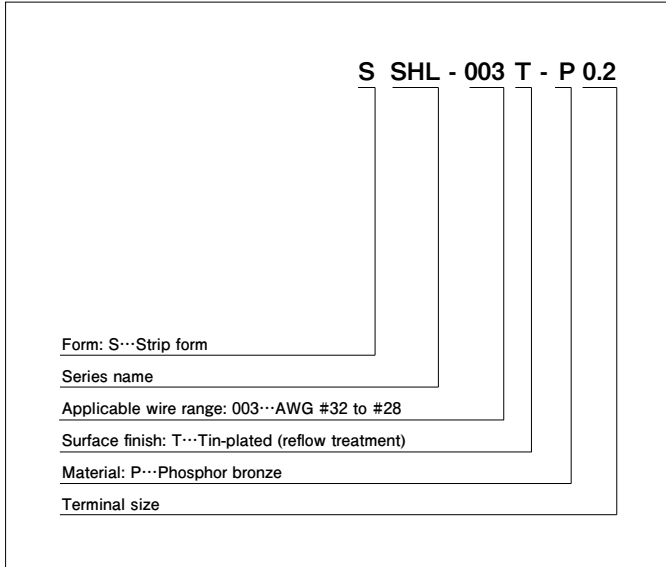

### Housing

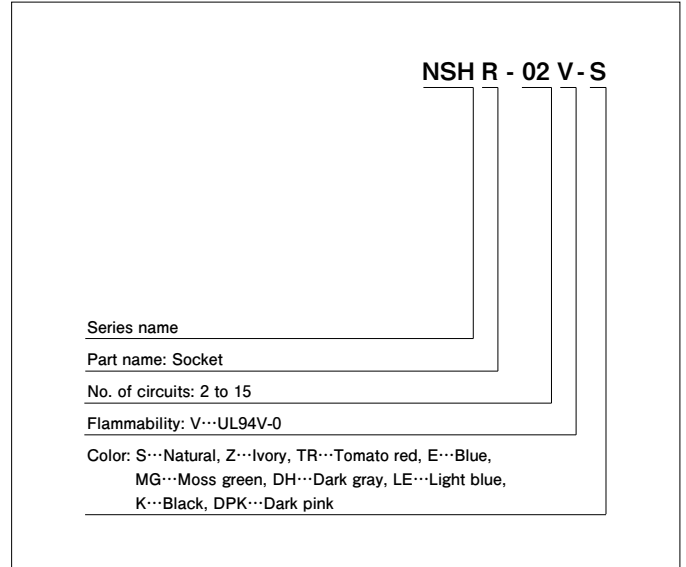

### Header

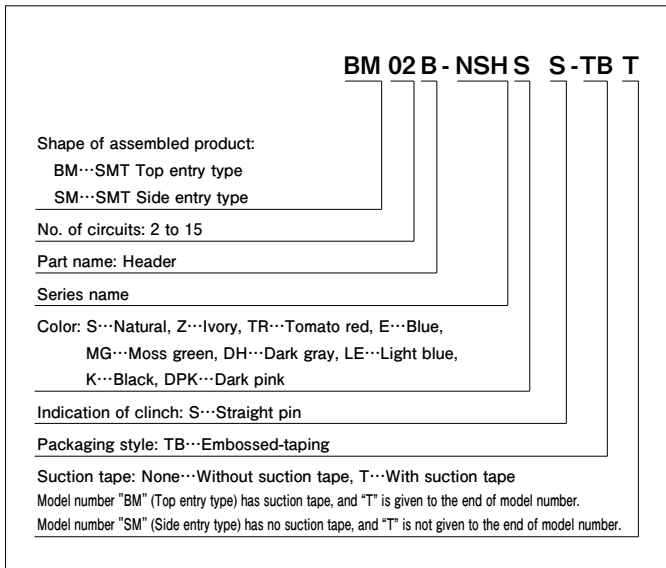

单击下面可查看定价，库存，交付和生命周期等信息

[>>JST\(杰世腾\)](#)