

# PUD CONNECTOR

2.0mm pitch/Disconnectable Crimp style connectors

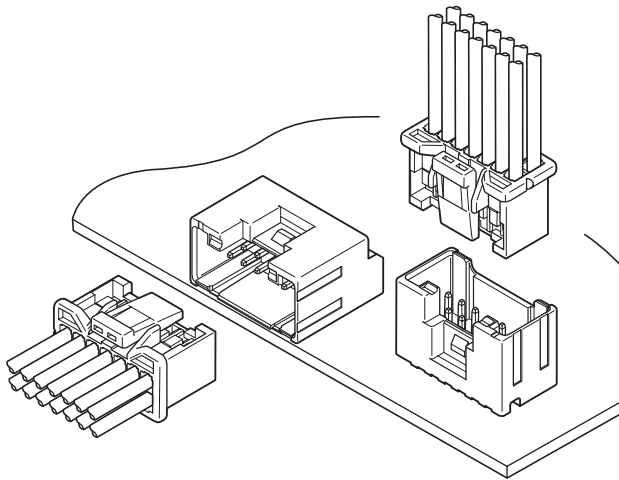

**This is a board-to-wire connector with secure locking device that has been designed to 2.0 mm pitch, crimping style and double-row. In spite of realizing low insertion force, the stable electric connection is demonstrated against the condition such as vibration, pinching and dry circuit. It is possible to unfasten the locking even if the header is surrounded with a case wall within height of header because the tip of locking device in receptacle does not protrude from its area.**

- High reliability contact
- Superior operability
- Secure locking structure
- Polarizing key for mounting on PC board

## Specifications

- Current rating: 3 A AC, DC (AWG #22)
  - Voltage rating: 250 V AC, DC
  - Temperature range: -25°C to +85°C  
(including temperature rise in applying electrical current)
  - Contact resistance: Initial value/ 10 mΩ max.  
After environmental tests/ 20 mΩ max.
  - Insulation resistance: 1,000 MΩ min.
  - Withstanding voltage: 800 VAC/minute
  - Applicable wire: Conductor size/ AWG #28 to #22  
Insulation O.D./ 0.76 to 1.5 mm
- \* Refer to "General Instruction and Notice when using Terminals and Connectors" at the end of this catalog.  
\* Contact JST for details.  
\* Compliant with RoHS.

## Standards

Recognized E60389

Certified LR20812

## PC board layout and Assembly layout

### Top entry type

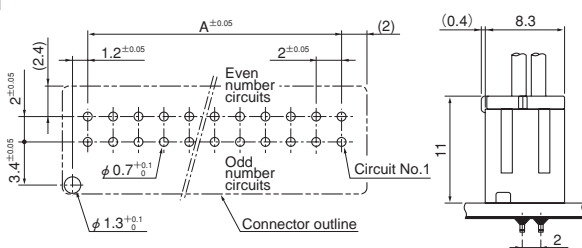

### Side entry type

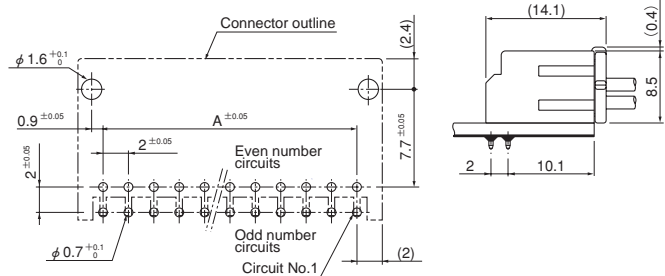

Note: 1. The above figure is the figure viewed from the connector mounting side.

2. Tolerances are non-cumulative: ±0.05 mm for all centers.

3. Hole dimensions differ according to the type of PC board and piercing method. The dimensions above should serve as a guideline. Contact JST for details.

### SMT type

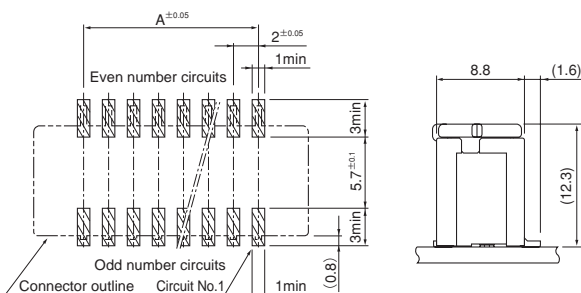

Note: 1. The above figure is the figure viewed from the connector mounting side.

2. Tolerances are non-cumulative: ±0.05 mm for all centers. The dimensions above should serve as a guideline. Contact JST for details.

# PUD CONNECTOR

## Contact

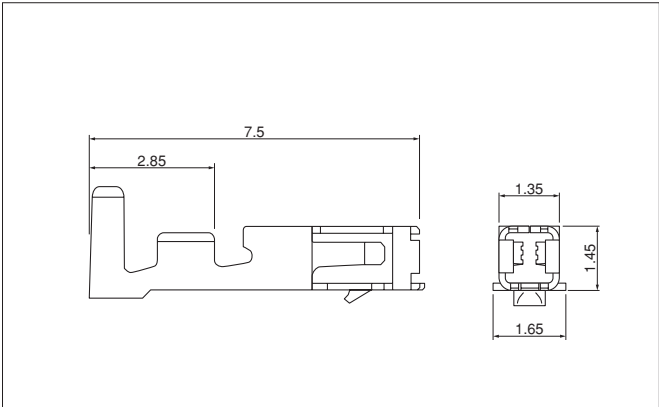

Model No.	Applicable wire		Insulation O.D. (mm)	Q'ty/reel
	mm <sup>2</sup>	AWG#		
<b>SPUD-001T-P0.5</b>	0.13~0.33	26~22	0.95~1.5	8,000
<b>SPUD-002T-P0.5</b>	0.08~0.22	28~24	0.76~1.5	

### Material and Finish

Copper alloy, tin-plated (reflow treatment)

### RoHS compliance

Contact	Crimping machine	Applicator		
		Crimp applicator	Dies	Crimp applicator with dies
<b>SPUD-001T-P0.5</b>	AP-K2N	MKS-L	MK/SPUD-001-05	APLMK SPUD001-05
		—	—	—
<b>SPUD-002T-P0.5</b>	AP-K2N	MKS-L	MK/SPUD-002-05	APLMK SPUD002-05
		—	—	—

## Housing

### <8, 10 circuits>

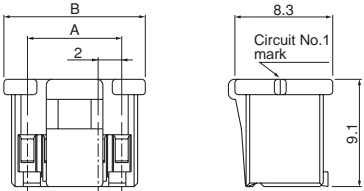

### <12, 14 circuits>

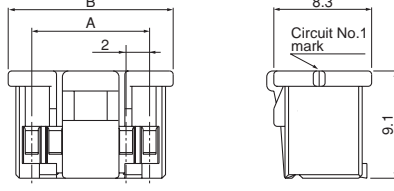

### <16, 18 circuits>

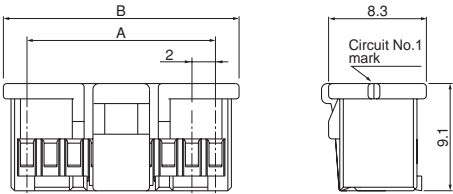

### <20, 22 circuits>

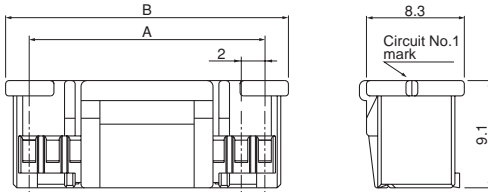

### <24 to 28 circuits>

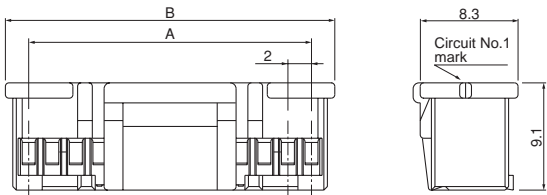

### <30 to 40 circuits>

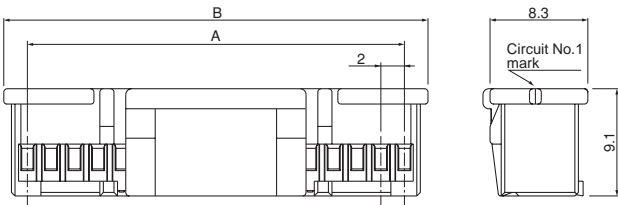

Circuits	Model No.	Dimensions (mm)		Q'ty/bag
		A	B	
8	<b>PUDP-08V-S</b>	6.0	10.0	1,000
10	<b>PUDP-10V-S</b>	8.0	12.0	1,000
12	<b>PUDP-12V-S</b>	10.0	14.0	1,000
14	<b>PUDP-14V-S</b>	12.0	16.0	1,000
16	<b>PUDP-16V-S</b>	14.0	18.0	1,000
18	<b>PUDP-18V-S</b>	16.0	20.0	1,000
20	<b>PUDP-20V-S</b>	18.0	22.0	1,000
22	<b>PUDP-22V-S</b>	20.0	24.0	1,000
24	<b>PUDP-24V-S</b>	22.0	26.0	1,000
26	<b>PUDP-26V-S</b>	24.0	28.0	1,000
28	<b>PUDP-28V-S</b>	26.0	30.0	500
30	<b>PUDP-30V-S</b>	28.0	32.0	500
32	<b>PUDP-32V-S</b>	30.0	34.0	500
34	<b>PUDP-34V-S</b>	32.0	36.0	500
36	<b>PUDP-36V-S</b>	34.0	38.0	500
38	<b>PUDP-38V-S</b>	36.0	40.0	500
40	<b>PUDP-40V-S</b>	38.0	42.0	500

### Material

PBT, UL94V-0, natural

### RoHS compliance

<For reference> As the color identification, the following alphabet shall be put in the underlined part. For availability, delivery and minimum order quantity, contact JST.

ex. **PUDP-08V-S**

S...natural Z...ivory E...blue R...red K...black TR...tomato red  
 MG...moss green DPK...dark pink CB...cobalt blue  
 DO...dark orange DP...dark purple DH...dark gray LE...light blue

# PUD CONNECTOR

## Through-hole type shrouded header

### Top entry type

<8, 10 circuits>

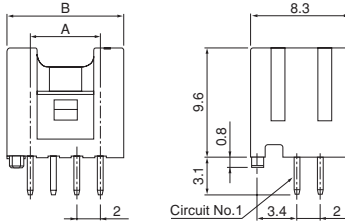

<12 to 18 circuits>

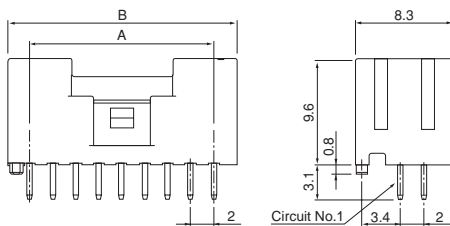

<20 to 40 circuits>

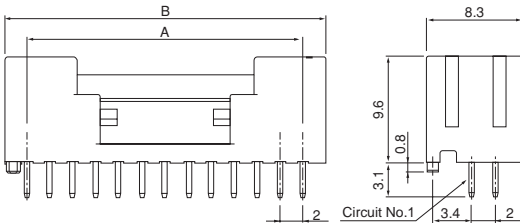

### Side entry type

<8, 10 circuits>

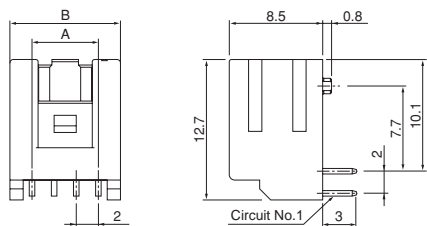

<12 to 18 circuits>

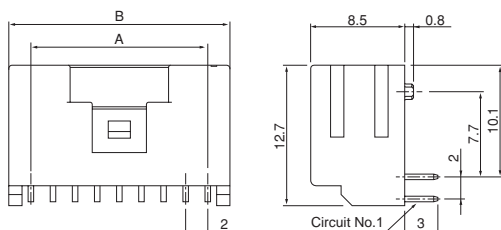

<20 to 40 circuits>

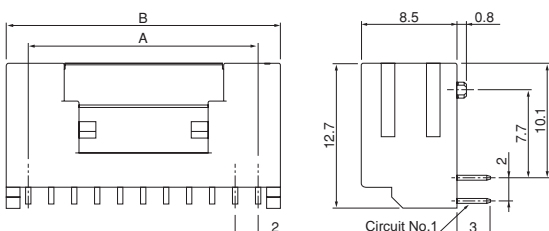

Circuits	Model No.			Dimensions (mm)		Q'ty/box
	Top entry type		Side entry type	A	B	
	Without boss	With boss	With boss			
8	B08B-PUDSS	B08B-PUDSS-1	S08B-PUDSS-1	6.0	10.0	3,300
10	B10B-PUDSS	B10B-PUDSS-1	S10B-PUDSS-1	8.0	12.0	2,750
12	B12B-PUDSS	B12B-PUDSS-1	S12B-PUDSS-1	10.0	14.0	2,310
14	B14B-PUDSS	B14B-PUDSS-1	S14B-PUDSS-1	12.0	16.0	1,980
16	B16B-PUDSS	B16B-PUDSS-1	S16B-PUDSS-1	14.0	18.0	1,760
18	B18B-PUDSS	B18B-PUDSS-1	S18B-PUDSS-1	16.0	20.0	1,650
20	B20B-PUDSS	B20B-PUDSS-1	S20B-PUDSS-1	18.0	22.0	1,430
22	B22B-PUDSS	B22B-PUDSS-1	S22B-PUDSS-1	20.0	24.0	1,320
24	B24B-PUDSS	B24B-PUDSS-1	S24B-PUDSS-1	22.0	26.0	1,210
26	B26B-PUDSS	B26B-PUDSS-1	S26B-PUDSS-1	24.0	28.0	1,100
28	B28B-PUDSS	B28B-PUDSS-1	S28B-PUDSS-1	26.0	30.0	1,100
30	B30B-PUDSS	B30B-PUDSS-1	S30B-PUDSS-1	28.0	32.0	990
32	B32B-PUDSS	B32B-PUDSS-1	S32B-PUDSS-1	30.0	34.0	880
34	B34B-PUDSS	B34B-PUDSS-1	S34B-PUDSS-1	32.0	36.0	880
36	B36B-PUDSS	B36B-PUDSS-1	S36B-PUDSS-1	34.0	38.0	770
38	B38B-PUDSS	B38B-PUDSS-1	S38B-PUDSS-1	36.0	40.0	770
40	B40B-PUDSS	B40B-PUDSS-1	S40B-PUDSS-1	38.0	42.0	770

### Material and Finish

Post: Copper alloy, copper-undercoated, tin-plated (reflow treatment)  
Wafer: Glass-filled PA 66, UL94V-0, natural

**RoHS compliance** This product displays (LF)(SN) on a label.

Note: Color indication was changed.

Berofe change; S...natural (ivory) , After change; S...natural

<For reference> As the color identification,  
the following alphabet shall be put in the underlined part.  
For availability, delivery and minimum order quantity, contact JST.

ex. **B08B-PUDSS-1**

S...natural Z...ivory E...blue R...red K...black TR...tomato red  
MG...moss green DPK...dark pink CB...cobalt blue  
DO...dark orange DP...dark purple DH...dark gray LE...light blue

# PUD CONNECTOR

## SMT type shrouded header

### <10 circuits>

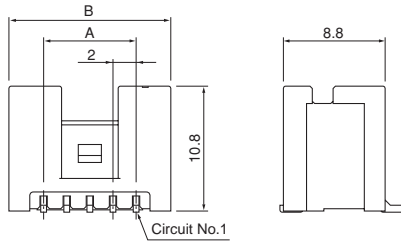

### <12 to 18 circuits>

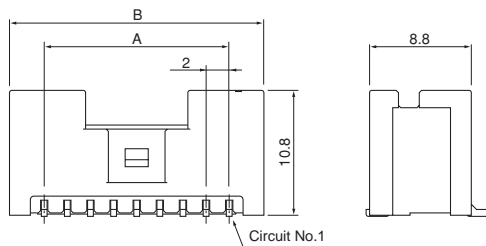

### <20, 22 circuits>

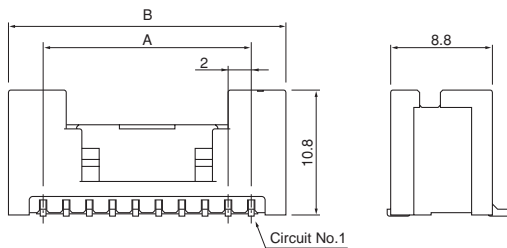

### <24 to 28 circuits>

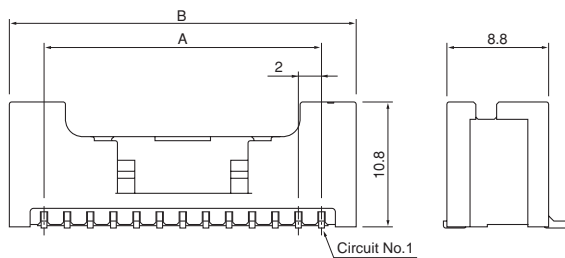

### <30 to 40 circuits>

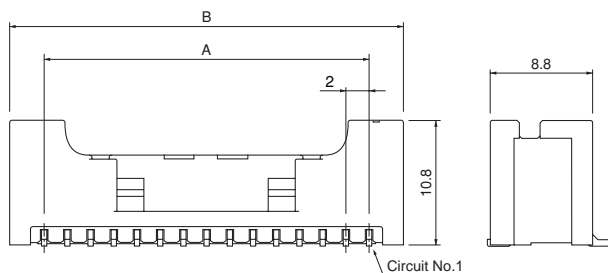

Circuits	Model No.	Dimensions (mm)		Qty/ reel
		A	B	
10	<b>BM10B-PUDSS-TFC</b>	8.0	14.0	400
12	<b>BM12B-PUDSS-TFC</b>	10.0	16.0	400
14	<b>BM14B-PUDSS-TFC</b>	12.0	18.0	400
16	<b>BM16B-PUDSS-TFC</b>	14.0	20.0	400
18	<b>BM18B-PUDSS-TFC</b>	16.0	22.0	400
20	<b>BM20B-PUDSS-TFC</b>	18.0	24.0	400
22	<b>BM22B-PUDSS-TFC</b>	20.0	26.0	400
24	<b>BM24B-PUDSS-TFC</b>	22.0	28.0	400
26	<b>BM26B-PUDSS-TFC</b>	24.0	30.0	400
28	<b>BM28B-PUDSS-TFC</b>	26.0	32.0	400
30	<b>BM30B-PUDSS-TFC</b>	28.0	34.0	400
32	<b>BM32B-PUDSS-TFC</b>	30.0	36.0	400
34	<b>BM34B-PUDSS-TFC</b>	32.0	38.0	400
36	<b>BM36B-PUDSS-TFC</b>	34.0	40.0	400
38	<b>BM38B-PUDSS-TFC</b>	36.0	42.0	400
40	<b>BM40B-PUDSS-TFC</b>	38.0	44.0	400

#### Material and Finish

Post: Copper alloy, copper-undercoated, tin-plated (reflow treatment)  
Wafer: Polyamide, UL94V-0, natural

**RoHS compliance** This product displays (LF)(SN) on a label.

<For reference> As the color identification,  
the following alphabet shall be put in the underlined part.  
For availability, delivery and minimum order quantity, contact JST.

ex. **BM-10B-PUDSS-TFC**

S...natural Z...ivory K...black TR...tomato red

MG...moss green DPK...dark pink CB...cobalt blue

DO...dark orange DP...dark purple DH...dark gray LE...light blue

单击下面可查看定价，库存，交付和生命周期等信息

[>>JST\(日本压着端子製造株式会社\)](#)