

NSHD CONNECTOR

1.0 mm pitch/Wire-to-Board connectors/Crimp style and Mating style

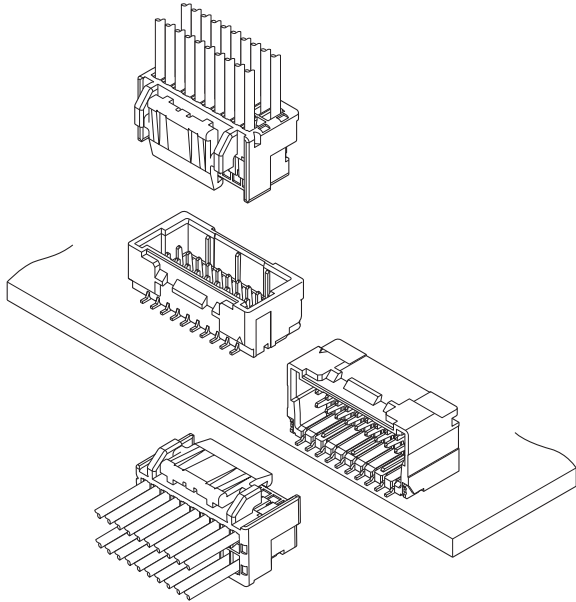

This is a wire-to-board connector with secure locking specification, which achieved excellent workability and withstanding external force.

Realize industry-leading space-saving, 1.0 mm pitch dual-row, and support a high densification of equipment.

- Excellent workability (Low insertion force)
- Withstanding external force
- Secure lock mechanism
- Space saving

■ Specifications

- Current rating: 1.0 A AC/DC (AWG #28)
- Voltage rating: 50 V AC/DC
- Temperature range: -25°C to +85°C
(including temperature rise in applying electrical current)
- Contact resistance:
 - Initial value/ 20 mΩ max.
 - After environmental tests/ 40 mΩ max.
- Insulation resistance: 100 MΩ min.
- Withstanding voltage:
 - There shall be no breakdown or flashover while applying 500 VAC for one minute.
- Applicable wire range:
 - Conductor size/ AWG #32 to AWG #28
 - Insulation O.D./ ϕ 0.4 mm to ϕ 0.8 mm
- * In using the products, refer to "Handling Precautions for Terminals and Connectors" described on our website (Technical documents of Product information page).
- * RoHS2 compliance
- * Dimensional unit: mm
- * Contact JST for details.

NSHD CONNECTOR

PC board layout and Assembly layout

Top entry type

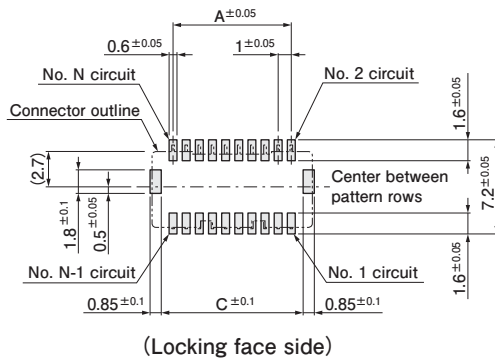

<16, 20, 24, 28, 32 circuits>

<40 circuits>

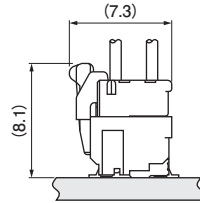
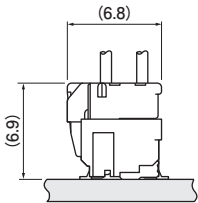

Side entry type

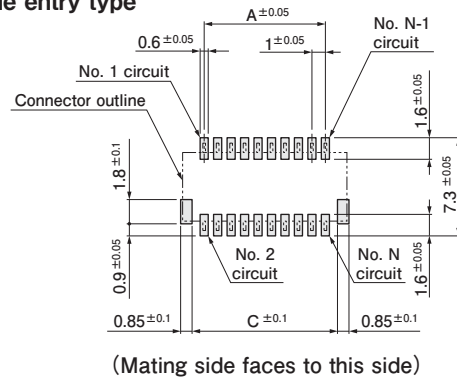

<16, 20, 24, 28, 32 circuits>

<40 circuits>

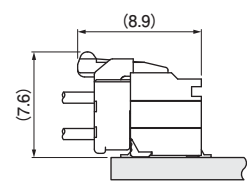
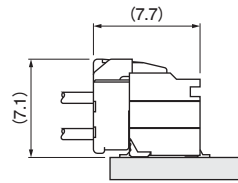

- Note: 1. The figure of PC board layout is the figure viewed from the connector mounting side.
 2. Dimensions A and C: See "Header" section on page 4.
 3. Tolerance for the PCB pattern pitch shall be ± 0.05 , and shall not accumulate more than ± 0.05 .
 4. The above dimensions are reference values. Please contact JST for details.

Contact

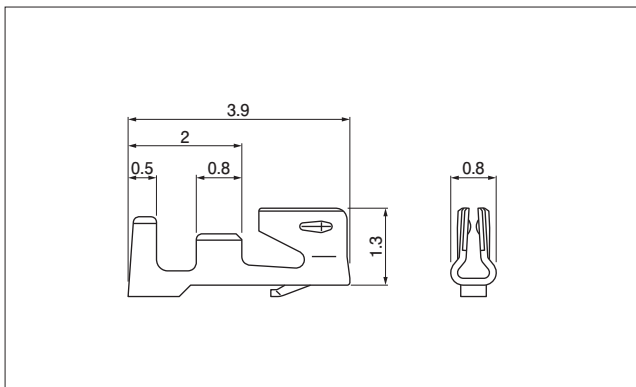

Model No.	Applicable wire range		Q'ty/ reel
	Conductor size AWG (mm ²)	Insulation O.D. (mm)	
SNSHD-003T-P0.2	#32 to #28 (0.032 to 0.08)	0.4 to 0.8	23,000

Material and Surface finish, etc.

Copper alloy, tin-plated

Crimping machine

Contact	Crimping machine	Applicator	Crimp applicator with dies
SNSHD-003T-P0.2	AP-K2N	MKS-L-10-3	APLMK SSH/L003-02

Note: Contact JST for fully automatic crimping applicator.

NSHD CONNECTOR

Socket housing

<16 circuits>

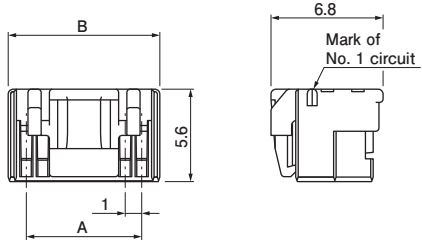

<20, 24, 28 circuits>

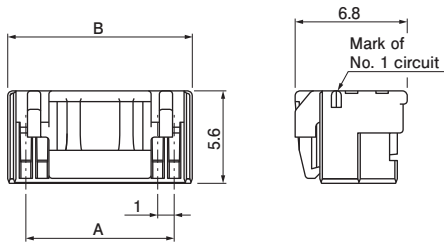

<32 circuits>

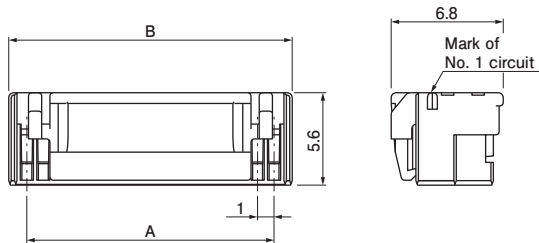

<40 circuits>

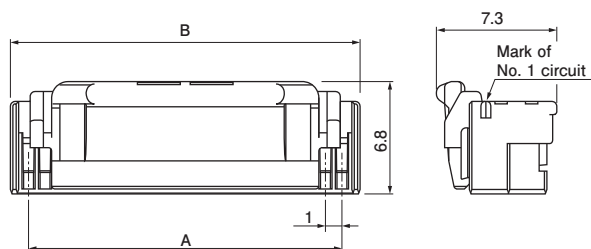

No. of circuits	Model No.	Dimensions (mm)		Q'ty/bag
		A	B	
16	NSHDR-16V-Z	7.0	9.2	2,500
20	NSHDR-20V-Z	9.0	11.2	2,000
24	NSHDR-24V-Z	11.0	13.2	1,500
28	NSHDR-28V-Z	13.0	15.2	1,000
32	NSHDR-32V-1-Z	15.0	17.2	1,000
40	NSHDR-40V-2-Z	19.0	21.2	900

Material and Surface finish, etc.

PBT, UL94V-0, ivory

NSHD CONNECTOR

Header

Top entry type

<16 circuits>

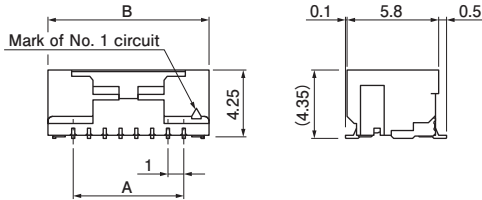

<20, 24, 28 circuits>

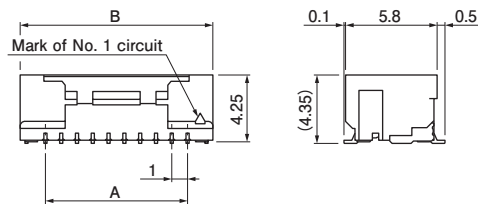

<32 circuits>

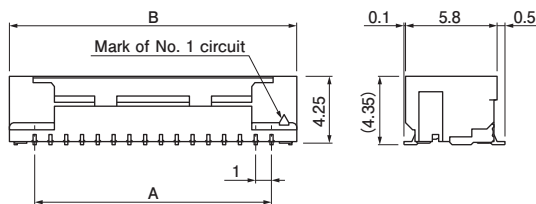

<40 circuits>

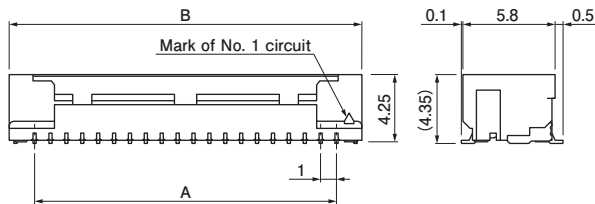

Side entry type

<16 circuits>

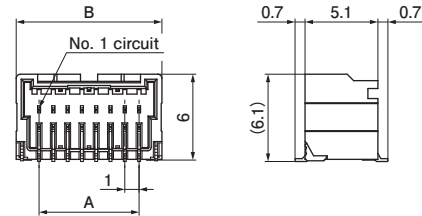

<20, 24, 28 circuits>

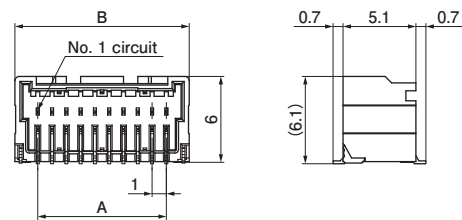

<32 circuits>

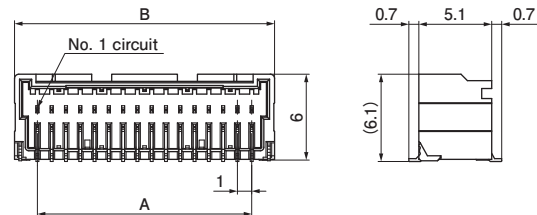

<40 circuits>

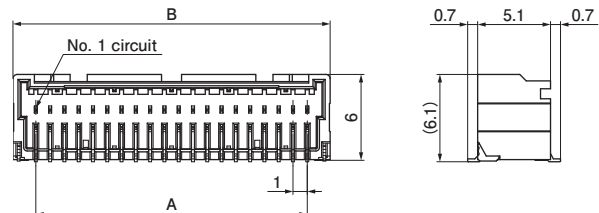

Top entry type

No. of circuits	Model No.	Dimensions (mm)			Q'ty/reel
		A	B	C	
16	BM16B-NSHDZS-TFT	7.0	10.2	8.8	1,600
20	BM20B-NSHDZS-TFT	9.0	12.2	10.8	1,600
24	BM24B-NSHDZS-TFT	11.0	14.2	12.8	1,600
28	BM28B-NSHDZS-TFT	13.0	16.2	14.8	1,600
32	BM32B-NSHDZS-1-TFT	15.0	18.2	16.8	1,600
40	BM40B-NSHDZS-1-TFT	19.0	22.2	20.8	1,600

Material and Surface finish, etc.

Header contact: Copper alloy, copper-undercoated, tin-plated
 Wafer: Polyamide, UL94V-0, ivory
 Reinforcing tab: Copper alloy, copper-undercoated, tin-plated

Note: 1. Dimension C: See "PC board layout" section on page 2.
 2. The products listed above are supplied on embossed-tape.

Side entry type

No. of circuits	Model No.	Dimensions (mm)			Q'ty/reel
		A	B	C	
16	SM16B-NSHDZS-TF	7.0	10.2	8.8	1,000
20	SM20B-NSHDZS-TF	9.0	12.2	10.8	1,000
24	SM24B-NSHDZS-TF	11.0	14.2	12.8	1,000
28	SM28B-NSHDZS-TF	13.0	16.2	14.8	1,000
32	SM32B-NSHDZS-1-TF	15.0	18.2	16.8	1,000
40	SM40B-NSHDZS-1-TF	19.0	22.2	20.8	1,000

Material and Surface finish, etc.

Header contact: Copper alloy, copper-undercoated, tin-plated
 Wafer: Polyamide, UL94V-0, ivory
 Reinforcing tab: Copper alloy, copper-undercoated, tin-plated

Note: 1. Dimension C: See "PC board layout" section on page 2.
 2. The products listed above are supplied on embossed-tape.

NSHD CONNECTOR

Model number allocation

Contact

S NSHD - 003 T - P 0.2

Supply form: Strip form

Series name

Applicable wire range: AWG #32 to AWG #28

Surface finish: Tin-plated

Material: Copper alloy

Applicable contact size

Socket housing

NSHD R - 32 V - 1 - Z

Series name

Type: Socket

No. of circuits

Flammability: UL94V-0

Supplementary symbol: Blank...16, 20, 24, 28 circuits
1...32 circuits
2...40 circuits

Color: Z...Ivory, TR...Tomato red, E...Blue

Header/ Top entry type

BM 32 B - NSHD Z S - 1 - TF T

Header type:
SMT top entry type

No. of circuits

Assembly product

Series name

Color: Z...Ivory, TR...Tomato red,
E...Blue

Supplementary symbol

Supplementary symbol: Blank...16, 20, 24, 28 circuits
1...32, 40 circuits

Packaging style: Embossed-taping

Suction tape: With suction tape

Header/ Side entry type

SM 32 B - NSHD Z S - 1 - TF

Header type:
SMT side entry type

No. of circuits

Assembly product

Series name

Color: Z...Ivory, TR...Tomato red,
E...Blue

Supplementary symbol

Supplementary symbol: Blank...16, 20, 24, 28 circuits
1...32, 40 circuits

Packaging style: Embossed-taping

单击下面可查看定价，库存，交付和生命周期等信息

[>>JST\(杰世腾\)](#)