

VH CONNECTOR

3.96 mm pitch/Disconnectable Crimp style connectors

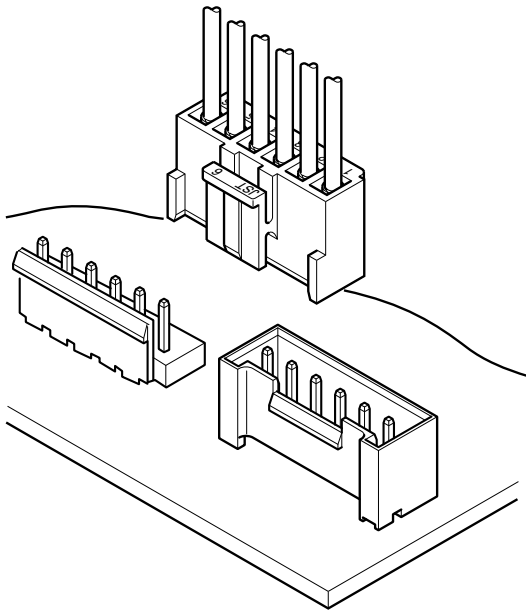

This small, field-proven connector for printed circuit boards is reliable and has a large current carrying capacity. It can be used with a wide variety of signal, power supply, and output circuits that appear in consumer electronic products.

- Proven box contact
- Compact connector with a large capacity
- Secure contact and mounting

Specifications

- Current rating: 10 A AC/DC (AWG #16)
- Voltage rating: 250 V AC/DC
- Temperature range: -25°C to +85°C
(including temperature rise in applying electrical current)
- Contact resistance: Initial value/ 10 mΩ max.
After environmental tests/ 20 mΩ max.
- Insulation resistance: 1,000 MΩ min.
- Withstanding voltage: 1,500 VAC/minute
- Applicable wire: AWG #22 to #16
- Applicable PC board thickness: 1.6 mm

Note:

Do not branch in parallel current which exceeds the rated current. If branched in parallel, current imbalance or other problems may develop. If it is absolutely necessary to branch such a large current in parallel, be sure to use contacts made of phosphor bronze. Design the circuits without causing imbalance and provide an extra margin for each circuit.

* In using the products, refer to "Handling Precautions for Terminals and Connectors" described on our website (Technical documents of Product information page).

* RoHS2 compliance

* Dimensional unit: mm

* Contact JST for details.

Standards

Ⓜ Recognized E60389

Ⓢ Certified LR20812

⚠ R75122

PC board layout and Assembly layout

Locking header Top entry type

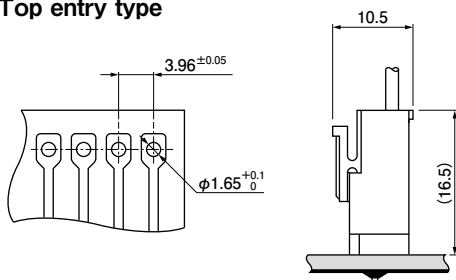

Locking header Side entry type

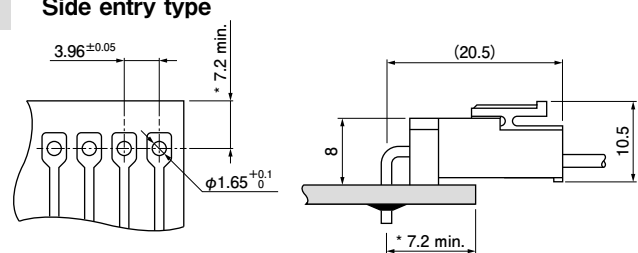

*11.0 max. when used with the VR connector receptacle.

Locking header Side entry type with PCB stabilizer

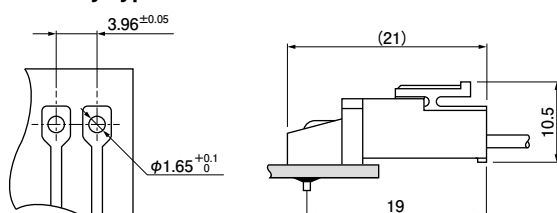

Shrouded header

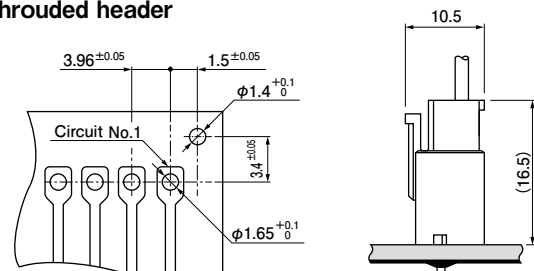

Note: 1. The above figure is the figure viewed from soldering side.

2. Tolerances are non-cumulative: ± 0.05 mm for all centers.

3. Please consider the pattern layout design in case of applying the large current.

4. Hole dimensions differ according to the type of PC board and piercing method. The dimensions above should serve as a guideline. Contact JST for details.

VH CONNECTOR

Contact

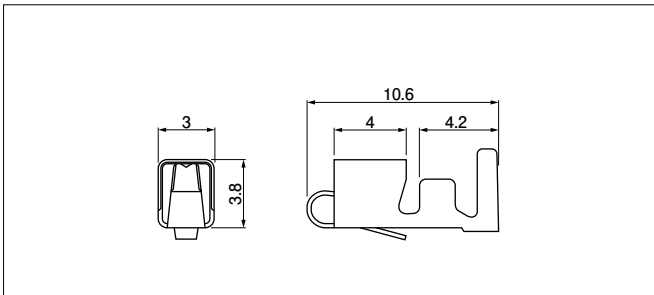

Model No.	Applicable wire		Insulation O.D. (mm)	Q'ty/reel
	mm ²	AWG #		
SVH-21T-P1.1	0.33 to 0.83	22 to 18	1.7 to 3.0	4,500
SVH-41T-P1.1	0.5 to 1.25	20 to 16	1.7 to 3.0	3,500

Material and Finish

Phosphor bronze, tin-plated (reflow treatment)

RoHS2 compliance

Note: When using retainer mountable type housing, applicable wire's insulation O. D. shall be 1.7 to 2.2 mm.

Contact	Crimping machine	Applicator		
		Crimp applicator	Dies	Crimp applicator with dies
SVH-21T-P1.1	AP-K2N	MKS-L	MK/SVH-21-11	APLMK SVH21-11
SVH-41T-P1.1			MK/SVH-41-11	APLMK SVH41-11

Note: Contact JST for fully automatic crimping applicator.

Housing

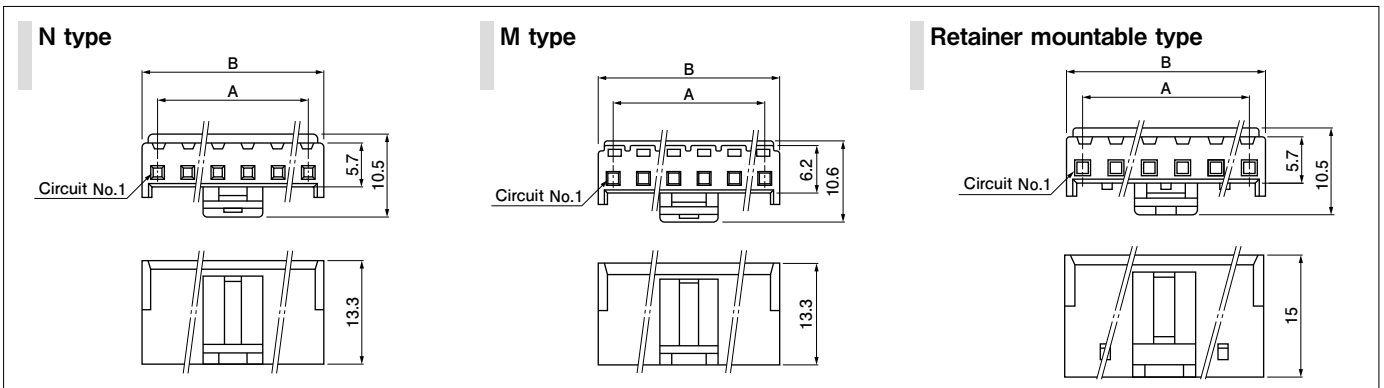

No. of circuits	Model No.			Dimensions (mm)		Q'ty/bag
	N type	M type	Retaine mountable type	A	B	
2	VHR-2N	VHR-2M	VHRR-2N	3.96	7.86	1,000
3	VHR-3N	VHR-3M	VHRR-3N	7.92	11.82	(*)
4	VHR-4N	VHR-4M	—	11.88	15.78	1,000
5	VHR-5N	VHR-5M	VHRR-5N	15.84	19.74	(*)
6	VHR-6N	VHR-6M	—	19.80	23.70	500
7	VHR-7N	VHR-7M	VHRR-7N	23.76	27.66	500
8	VHR-8N	—	VHRR-8N	27.72	31.62	500
9	VHR-9N	VHR-9M	VHRR-9N	31.68	35.58	500
10	VHR-10N	—	—	35.64	39.54	500
11	VHR-11N	—	—	39.60	43.50	500

Material and Finish

PA 6, UL94V-0, natural (white)

RoHS2 compliance

- Note: 1. Models identified as VHR-() M incorporate measures to prevent electric shock and are thus safer in regard to high voltages.
 2. The applicable housing for 2 circuits shrouded header is "VHR-2N" only. "VHRR-2N" is not applicable.
 3. Contact JST for Glow Wire compliant connectors.

(*) N / M type ; 1,000
 Retainer mountable type ; 500

Retainer

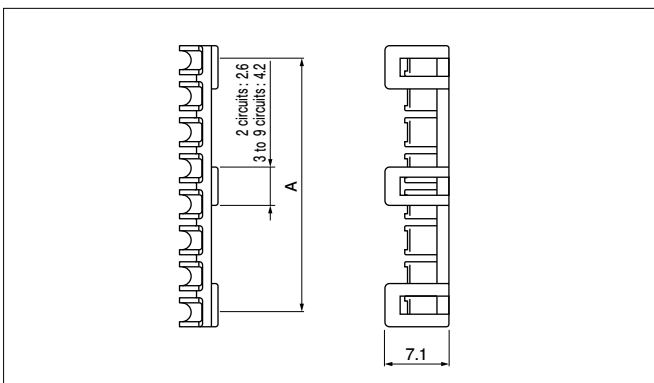

No. of circuits	Model No.	A	Q'ty/bag
2	VHS-2V	3.70	1,000
3	VHS-3V	7.52	1,000
5	VHS-5V	15.44	1,000
7	VHS-7V	23.36	1,000
8	VHS-8V	27.32	1,000
9	VHS-9V	31.28	1,000

Material and Finish

Glass-filled PA 66, UL94V-0, natural (ivory)

RoHS2 compliance

VH CONNECTOR

Locking header

Top entry type

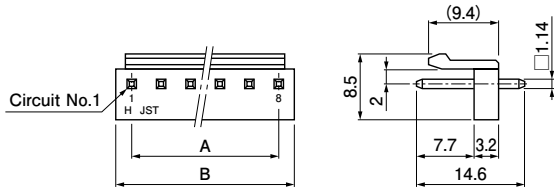

Side entry type

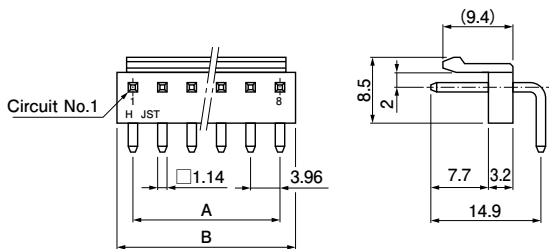

No. of circuits	Model No.		Dimensions (mm)		Q'ty/box	
	Top entry type	Side entry type	A	B	Top entry type	Side entry type
2	B2P-VH	B2PS-VH	3.96	7.86	1,000	1,000
3	B3P-VH	B3PS-VH	7.92	11.82	1,000	500
4	B4P-VH	B4PS-VH	11.88	15.78	500	500
5	B5P-VH	B5PS-VH	15.84	19.74	500	250
6	B6P-VH	B6PS-VH	19.80	23.70	250	250
7	B7P-VH	B7PS-VH	23.76	27.66	250	250
8	B8P-VH	B8PS-VH	27.72	31.62	200	200
9	B9P-VH	B9PS-VH	31.68	35.58	200	200
10	B10P-VH	B10PS-VH	35.64	39.54	200	100

Material and Finish

Post: Brass, copper-undercoated, tin-plated (reflow treatment)
Wafer: PA 66, UL94V-0, natural (white)

RoHS2 compliance This product displays (LF)(SN) on a label.
Note: 1. Headers with a reduced number of posts are also available.
Contact JST for details.
2. Contact JST for Glow Wire compliant connectors.

Top entry type of PBT

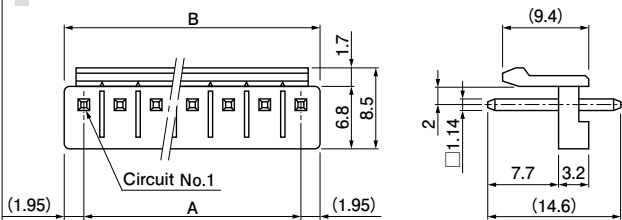

Side entry type with PCB stabilizer

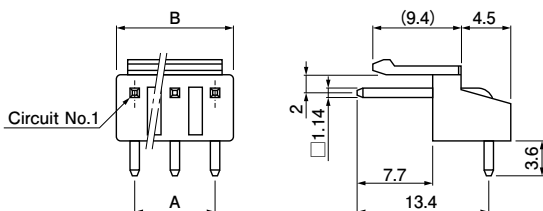

No. of circuits	Model No.		Dimensions (mm)		Q'ty/box	
	Top entry type of PBT	Side entry type with PCB stabilizer	A	B	Top entry type	Side entry type
2	B2P-VH-B	S2P-VH	3.96	7.86	1,000	1,000
3	B3P-VH-B	S3P-VH	7.92	11.82	1,000	500
4	B4P-VH-B	S4P-VH	11.88	15.78	500	500
5	B5P-VH-B	S5P-VH	15.84	19.74	500	250
6	B6P-VH-B	S6P-VH	19.80	23.70	250	250
7	B7P-VH-B	S7P-VH	23.76	27.66	250	250
8	B8P-VH-B	—	27.72	31.62	200	—
9	B9P-VH-B	—	31.68	35.58	200	—
10	B10P-VH-B	—	35.64	39.54	200	—
11	B11P-VH-B	—	39.60	43.50	200	—

Material and Finish

Post: Brass, copper-undercoated, tin-plated (reflow treatment)
Wafer: Top entry type of PBT: Glass-filled PBT, UL94V-0, natural (white)
Side entry type with PCB stabilizer: PA 66, UL94V-0, natural (white)

RoHS2 compliance This product displays (LF)(SN) on a label.

Shrouded header

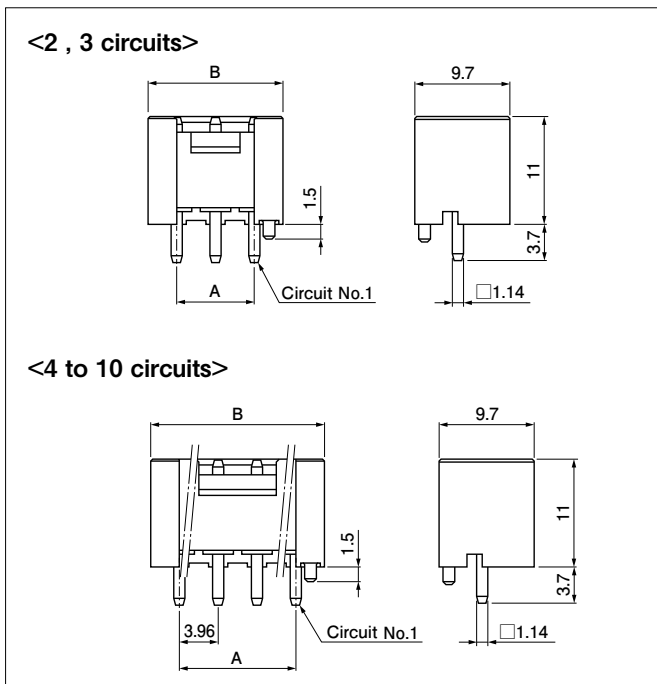

No. of circuits	Model No.	Dimensions (mm)		Q'ty/box
		A	B	
2	B2P-VH-FB-B	3.96	9.80	250
3	B3P-VH-FB-B	7.92	13.76	200
4	B4P-VH-FB-B	11.88	17.72	150
5	B5P-VH-FB-B	15.84	21.68	200
6	B6P-VH-FB-B	19.80	25.64	200
7	B7P-VH-FB-B	23.76	29.60	100
8	B8P-VH-FB-B	27.72	33.56	100
9	B9P-VH-FB-B	31.68	37.52	100
10	B10P-VH-FB-B	35.64	41.48	125

Material and Finish

Post: Copper alloy, copper-undercoated, tin-plated (reflow treatment)
Wafer: Glass-filled PBT, UL94V-0, natural (white)

RoHS2 compliance This product displays (LF)(SN) on a label.
Note: The applicable housing for 2 circuits shrouded header is "VHR-2N" only. "VHRR-2N" is not applicable.

Model number allocation

Contact

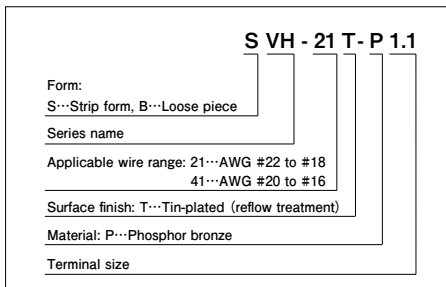

Housing

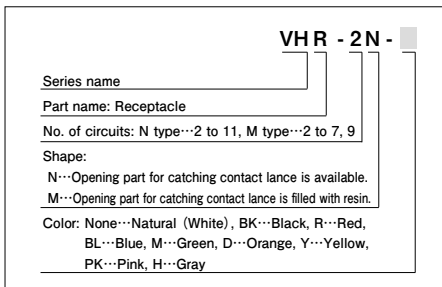

Retainer mountable type housing

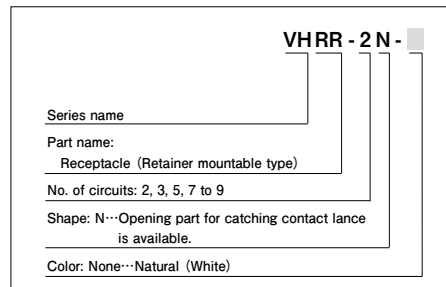

Retainer

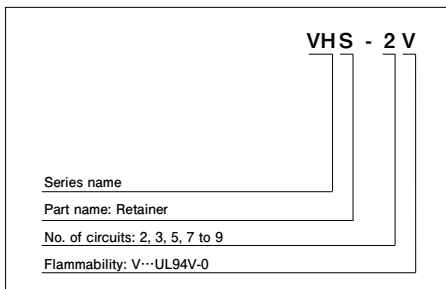

Header

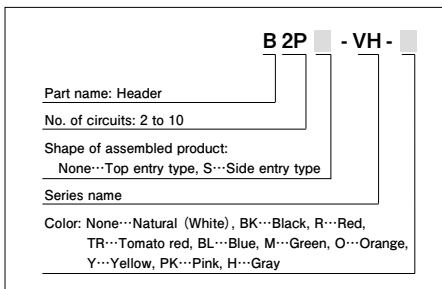

Header Top entry type of PBT

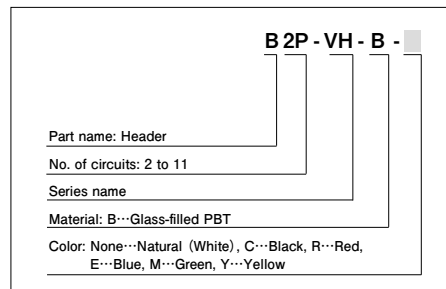

Header Side entry type with PCB stabilizer

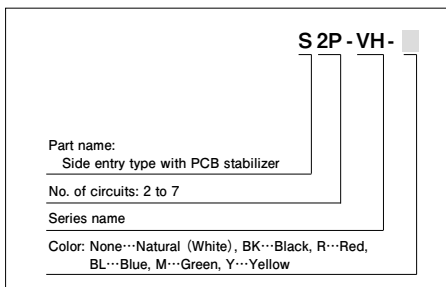

Shrouded header

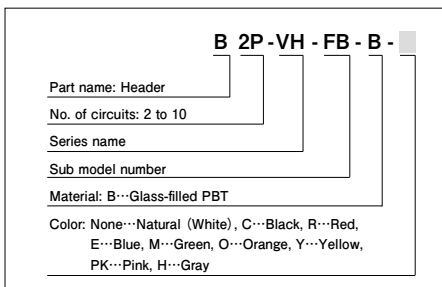

Note: Depending on the colors, it may take some time for delivery.

VH CONNECTOR

Post-omitted Header

- 1) When giving the polarity to the product by removing the post (N-1)th circuit
 However, since the product that the 2nd post of 3-circuit connector is omitted doesn't have polarity, select 3).

B *1 P *2 -VH

*1; No. of circuits (No. of posts)
 *2; Circuit No. of used original header

e.g.)

Circuit No.	1	2	3	4	5	6	7
Circuit (post)	○	○	○	○	○	×	○
Model No.	B6P7-VH						

○; With circuit (post) ×; Without circuit (post)

- 2) When giving the polarity to the product by removing the post in 2nd circuit
 However, since the product that the 2nd post of 3-circuit connector is omitted doesn't have polarity, select 3).

B *1 P *2 -VH-L

e.g.)

Circuit No.	1	2	3	4	5	6	7
Circuit (post)	○	×	○	○	○	○	○
Model No.	B6P7-VH-L						

- 3) When the pitch is set again
 1. When setting two times of pitch with omitting every other one post
 However, posts shall be inserted in No.1-circuit and No. N-circuit.

B *1 P *2 -VH

e.g.)

Circuit No.	1	2	3	4	5	6	7
Circuit (post)	○	×	○	×	○	×	○
Model No.	B4P7-VH						

2. When setting three times of pitch with omitting every other two posts
 However, posts shall be inserted in No.1-circuit and No. N-circuit.

B *1 P *2 -VH

e.g.)

Circuit No.	1	2	3	4	5	6	7
Circuit (post)	○	×	×	○	×	×	○
Model No.	B3P7-VH						

3. When setting four times of pitch with omitting every other three posts
 However, posts shall be inserted in No.1-circuit and No. N-circuit.

B *1 P *2 -VH

e.g.)

Circuit No.	1	2	3	4	5	6	7	8	9
Circuit (post)	○	×	×	×	○	×	×	×	○
Model No.	B3P9-VH								

单击下面可查看定价，库存，交付和生命周期等信息

[>>JST\(杰世腾\)](#)