

JMD CONNECTOR

Board-to-board connectors

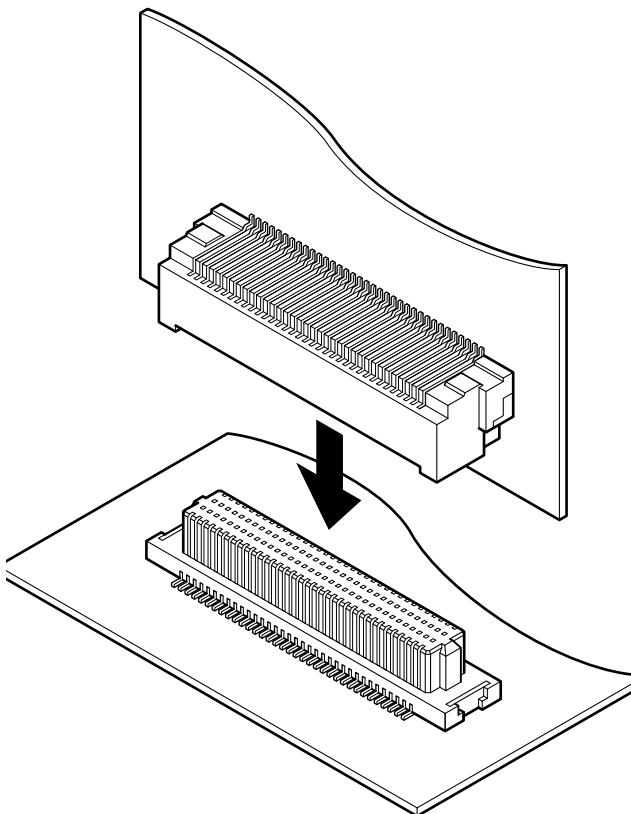

This connector is 0.5 mm pitch SMT type board-to-board connector with horizontal and vertical connection.



Features

• Smooth connection

Thanks to the cantilever type contacts, mating is very smooth.

• Distortion preventive construction

Box-shaped plug housing has the guide ribs on both ends, which prevents distortion, and offsetting the rib from the center axis provides the mating directionality.

• Wide range of circuits

No. of circuits available are from 20 to 100, every 10 circuits.

• Embossed taping for automatic mounting

This connector is supplied in embossed tape packaging, for mounting by automatic placement machines.

Specifications

- Current rating: 0.5 A AC, DC
- Voltage rating: 50 V AC, DC
- Temperature range: -25°C to +85°C
(including temperature rise in applying electrical current)
- Contact resistance: Initial value/ 50 mΩ max.
After environmental tests/ 100 mΩ max.
- Insulation resistance: 50 MΩ min.
- Withstanding voltage: 100 VAC/minute

* Refer to "General Instruction and Notice when using Terminals and Connectors" at the end of this catalog.

* Contact JST for details.

* Compliant with RoHS.

Standards

Recognized E60389

Certified LR20812

JMD CONNECTOR

Plug

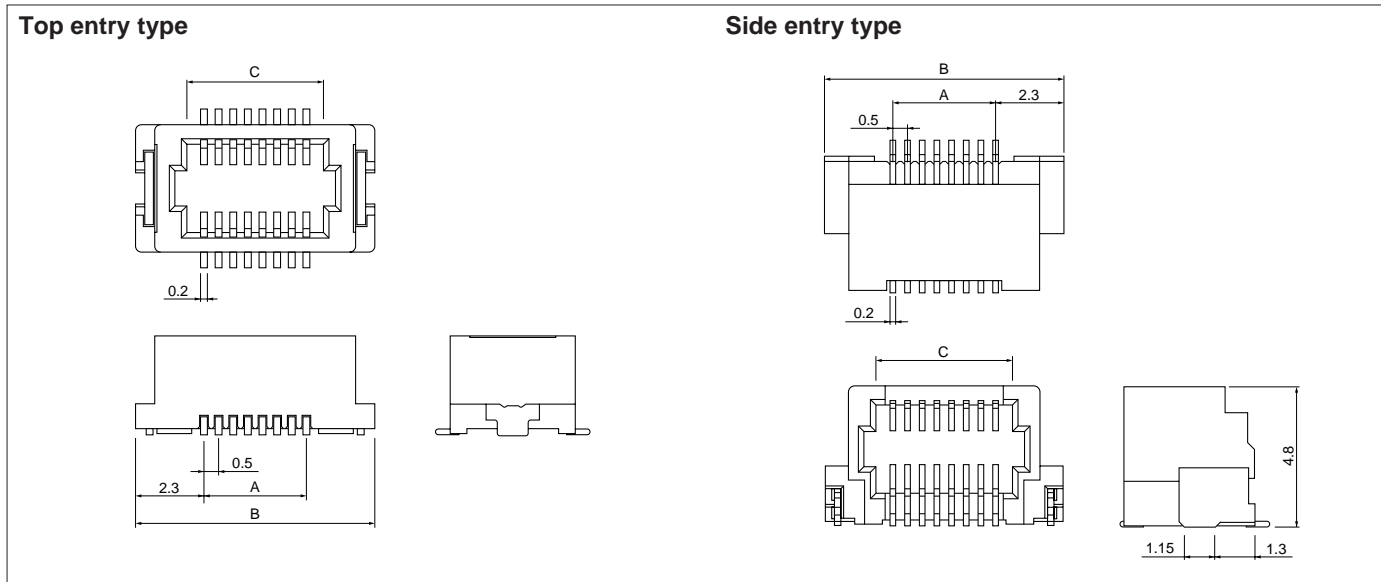

Circuits	Model No.				Dimensions (mm)			Q'ty/ reel
	Top entry type			Side entry type	A	B	C	
	4.5 mm	5.0 mm	6.0 mm					
20	20P-JMDSS-G-1-TF	–	–	20PS-JMDSS-G-1-TF	4.5	9.1	5.7	1,500
30	–	30P5.0-JMDSS-G-1-TF	–	30PS-JMDSS-G-1-TF	7.0	11.6	8.2	1,500
40	40P-JMDSS-G-1-TF	40P5.0-JMDSS-G-1-TF	–	40PS-JMDSS-G-1-TF	9.5	14.1	10.7	1,500
50	50P-JMDSS-G-1-TF	–	50P6.0-JMDSS-G-1-TF	50PS-JMDSS-G-1-TF	12.0	16.6	13.2	1,500
60	60P-JMDSS-G-1-TF	–	60P6.0-JMDSS-G-1-TF	60PS-JMDSS-G-1-TF	14.5	19.1	15.7	1,500
70	70P-JMDSS-G-1-TF	–	70P6.0-JMDSS-G-1-TF	70PS-JMDSS-G-1-TF	17.0	21.6	18.2	1,500
80	80P-JMDSS-G-1-TF	–	–	80PS-JMDSS-G-1-TF	19.5	24.1	20.7	1,500
100	100P-JMDSS-G-1-TF	–	–	100PS-JMDSS-G-1-TF	24.5	29.1	25.7	1,500

Material and Finish

Contact: Phosphor bronze, nickel-undercoated, gold-plated
Housing: PA 6T, UL94V-0
Solder tab: Brass, copper-undercoated, tin-plated (reflow treatment)

RoHS compliance This product displays (LF)(SN) on a label.
Note: The products listed above are supplied on embossed-tape.

Receptacle

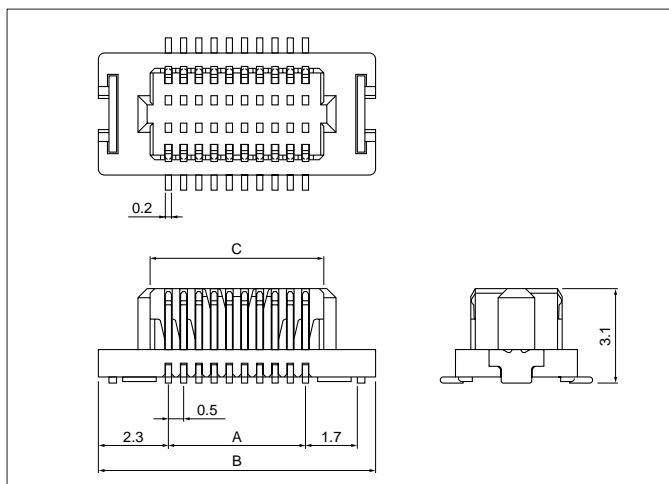

Circuits	Model No.	Dimensions (mm)			Q'ty/ reel
		A	B	C	
20	20R-JMDSS-G-1-TF(S)	4.5	9.1	5.7	1,500
30	30R-JMDSS-G-1-TF(S)	7.0	11.6	8.2	1,500
40	40R-JMDSS-G-1-TF(S)	9.5	14.1	10.7	1,500
50	50R-JMDSS-G-1-TF(S)	12.0	16.6	13.2	1,500
60	60R-JMDSS-G-1-TF(S)	14.5	19.1	15.7	1,500
70	70R-JMDSS-G-1-TF(S)	17.0	21.6	18.2	1,500
80	80R-JMDSS-G-1-TF(S)	19.5	24.1	20.7	1,500
100	100R-JMDSS-G-1-TF(S)	24.5	29.1	25.7	1,500

Material and Finish

Contact: Phosphor bronze, nickel-undercoated, gold-plated
Housing: PA 6T, UL94V-0
Solder tab: Brass, copper-undercoated, tin-plated (reflow treatment)

RoHS compliance This product displays (LF)(SN) on a label.
Note: The products listed above are supplied on embossed-tape.

Plug with polarizing key

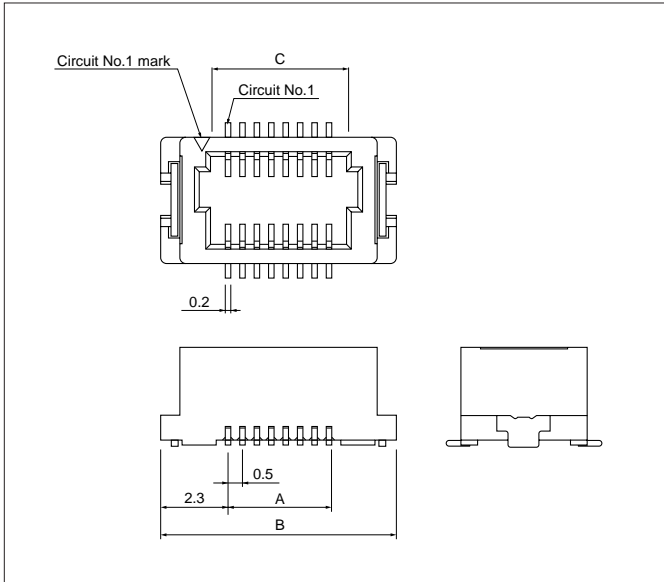

Cir-cuits	Model No.	Dimensions (mm)			Q'ty/ reel
	Stacking height /4.5 mm	A	B	C	
60	60P-JMDHS-GAN-1A-TF (A)	14.5	19.1	15.7	1,500

Material and Finish

Contact: Phosphor bronze, nickel-underplated, gold-plated (nickel-stripe)
Housing: PA 6T, UL94V-0, gray
Solder tab: Brass, copper-undercoated, tin-plated (reflow treatment)

RoHS compliance This product displays (LF)(SN) on a label.
The product listed above are supplied on embossed-tape.

Receptacle with polarizing key

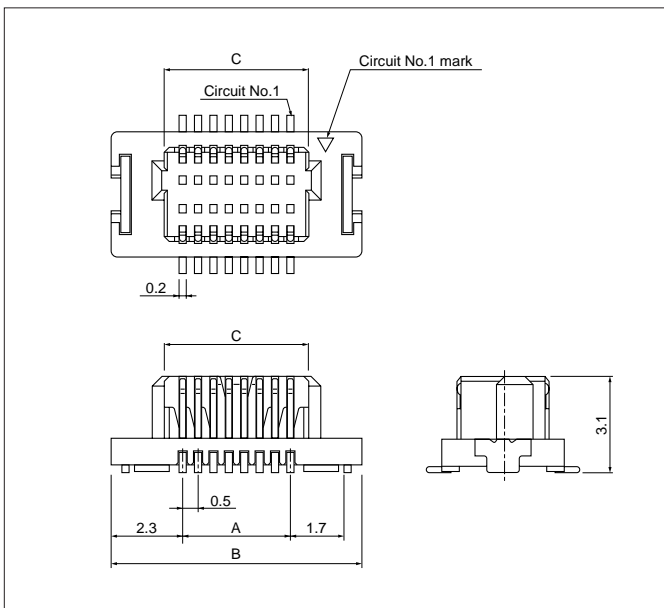

Cir-cuits	Model No.	Dimensions (mm)			Q'ty/ reel
	Stacking height /4.5 mm	A	B	C	
60	60R-JMDHS-GAN-1A-TF (SA)	14.5	19.1	15.7	1,500

Material and Finish

Contact: Phosphor bronze, nickel-underplated, gold-plated (nickel-stripe)
Housing: PA6T, UL94V-0, gray
Solder tab: Brass, copper-undercoated, tin-plated (reflow treatment)

RoHS compliance This product displays (LF)(SN) on a label.
The product listed above are supplied on embossed-tape.

JMD CONNECTOR

PC board layout (viewed from component side) and Assembly layout

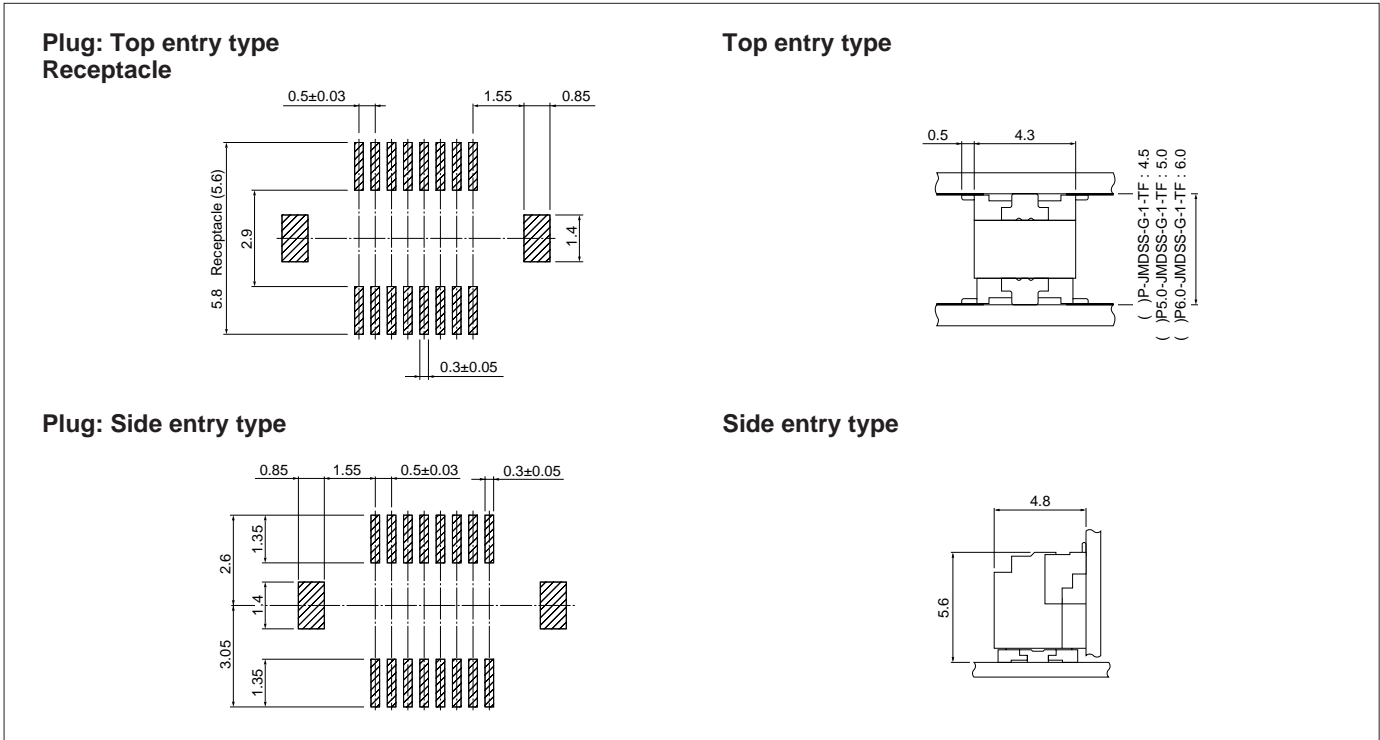

Note: 1. Tolerances are non-cumulative: ±0.03 mm for all centers.
 2. The dimensions above should serve as a guideline. Contact JST for details.

PC board layout (viewed from component side) and Assembly layout / with polarizing key

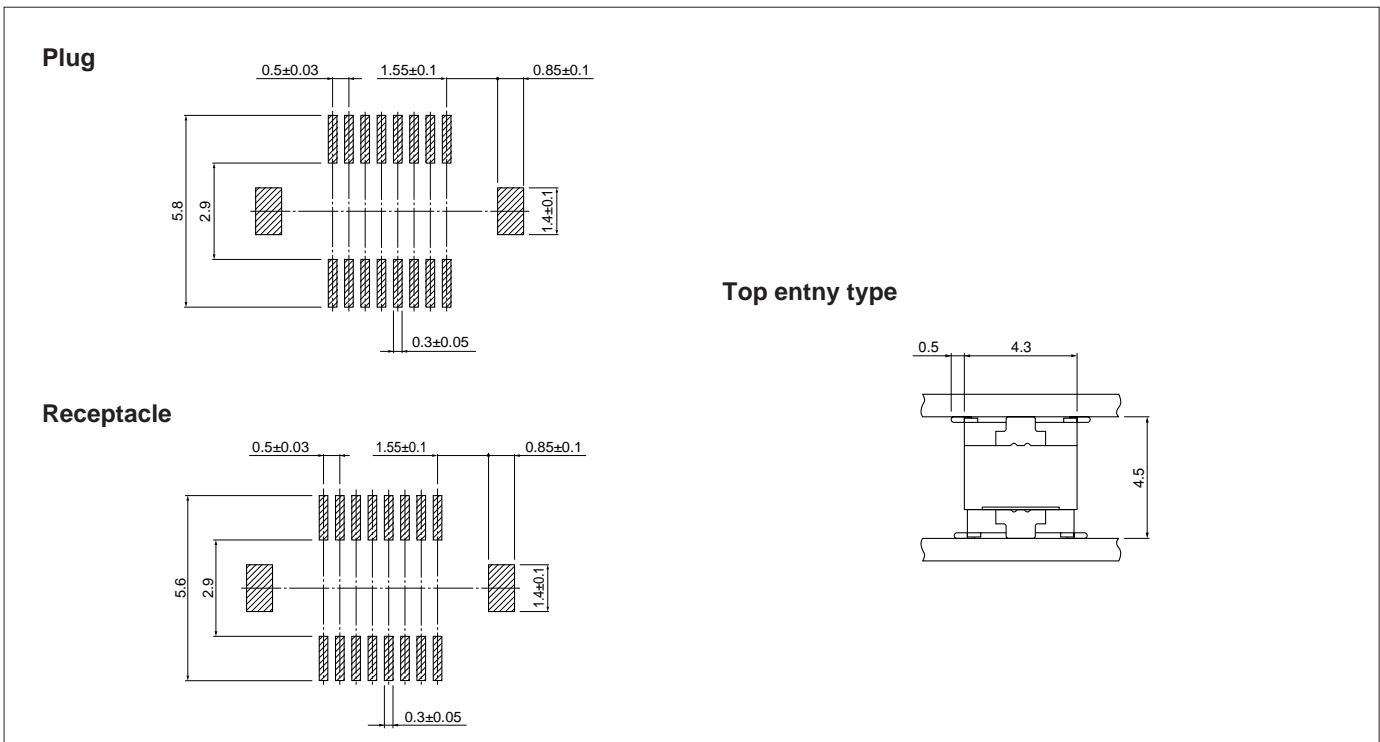

Note: 1. Tolerances are non-cumulative: ±0.03 mm for all centers.
 2. The dimensions above should serve as a guideline. Contact JST for details.

单击下面可查看定价，库存，交付和生命周期等信息

[>>JST\(杰世腾\)](#)