

Spec. No.: RLP-K-HTS-0001 /12

Date: 2017. 4. 21

Data sheet

Title: METAL-PLATE CHIP RESISTOR; LOW OHM

Style: RLP16,20,32,63, MLP20,32,63

AEC-Q200 qualified

RoHS COMPLIANCE ITEM

Halogen and Antimony Free

- Note:
- Stock conditions
 - Temperature: +5°C ~ +35°C
 - Relative humidity: 25% ~ 75%
 - The period of guarantee: Within 2 year from shipment by the company.
Solderability shall be satisfied.
 - Product specification contained in this data sheet are subject to change at any time without notice
 - If you have any questions or a Purchasing Specification for any quality Agreement is necessary, please contact our sales staff.



釜屋電機株式會社
KAMAYA ELECTRIC CO., LTD.

Hokkaido Research Center
Approval by: T. Sannomiya
Drawing by: M. Shibuya

Title: METAL-PLATE CHIP RESISTOR; LOW OHM
 RLP16, 20, 32, 63, MLP20,32, 63

Page: 1/24

1. Scope

1.1 This data sheet covers the detail requirements for metal-plate chip resistor ; low ohm, style of RLP16, 20, 32, 63, MLP20,32, 63.

1.2 Applicable documents

JIS C 5201-1: 2011, JIS C 5201-8: 2014, JIS C 5201-8-1: 2014
 IEC60115-1: 2008, IEC60115-8: 2009, IEC60115-8-1: 2014

2. Classification

Type designation shall be the following form.

(Example) RLP 63 K R010 F TE
 1 2 3 4 5 6

Style

1 Metal - plate chip resistor; low ohm  Style
 2 Size

RLP16	1608 size, 0.33W
RLP20	2012 size, 0.5W
RLP32	3216 size, 1W
RLP63	6332 size, 1W
MLP20	2012 size, 1W
MLP32	3216 size, 1.5W
MLP63	6332 size, 2W

3 Temperature coefficient of resistance

N	$\pm 70 \times 10^{-6} / ^\circ\text{C}$
K	$\pm 100 \times 10^{-6} / ^\circ\text{C}$
-(Dash)	$\pm 150 \times 10^{-6} / ^\circ\text{C}$

4 Rated resistance

1L50	1.5m Ω
R002	2m Ω

5 Tolerance on rated resistance

F	$\pm 1\%$
J	$\pm 5\%$

6 Packaging form

TP	Paper taping
TE	Embossed taping

3. Rating

3.1 The ratings shall be in accordance with Table-1.

3.1.1 RLP series

Table-1(1)

Style	Rated dissipation (W)	Rated current (A)	Temperature coefficient of resistance ($10^{-6}/^{\circ}\text{C}$)		Rated resistance (m Ω)	Tolerance on rated resistance
			K	± 70		
RLP16	0.33	8.1	K	100	5	F($\pm 1\%$) J($\pm 5\%$)
			N	± 70		
		5.7	K	100	10	
			N	± 70		
RLP20	0.5	15.8	K	100	2	
			N	± 70		
		12.9	K	100	3	
			N	± 70		
		11.1	K	100	4	
			N	± 70		
		10.0	K	100	5	
			N	± 70		
		9.1	K	100	6	
			N	± 70		
		8.4	K	100	7	
			N	± 70		
		7.9	K	100	8	
			N	± 70		
		7.4	K	100	9	
			N	± 70		
7.0	K	100	10			
	N	± 70				

Table-1(2)

Style	Rated dissipation (W)	Rated current (A)	Temperature coefficient of resistance ($10^{-6}/^{\circ}\text{C}$)		Rated resistance (m Ω)	Tolerance on rated resistance
RLP32	1.0	31.6	-(Standard)	± 150	1	F($\pm 1\%$) J($\pm 5\%$)
			K	± 100		
		22.3	K	± 100	2	
			N	± 70		
		18.2	K	± 100	3	
			N	± 70		
		15.8	K	± 100	4	
			N	± 70		
		14.1	K	± 100	5	
			N	± 70		
		12.9	K	± 100	6	
			N	± 70		
		11.9	K	± 100	7	
			N	± 70		
		11.1	K	± 100	8	
N	± 70					
10.5	K	± 100	9			
	N	± 70				
10	K	± 100	10			
	N	± 70				
9.5	K	± 100	11			
	N	± 70				
9.1	K	± 100	12			
	N	± 70				
8.7	K	± 100	13			
	N	± 70				
8.4	K	± 100	14			
	N	± 70				
8.1	K	± 100	15			
	N	± 70				

Table-1(3)

Style	Rated dissipation (W)	Rated current (A)	Temperature coefficient of resistance ($10^{-6}/^{\circ}\text{C}$)		Rated resistance (m Ω)	Tolerance on rated resistance
			-(Standard)	± 150		
RLP63	2.0	44.7		± 150	1	F($\pm 1\%$) J($\pm 5\%$)
			K	± 100		
			N	± 70		
	1.0	22.3	K	± 100	2	
			N	± 70		
		18.2	K	± 100	3	
			N	± 70		
		15.8	K	± 100	4	
			N	± 70		
		14.1	K	± 100	5	
			N	± 70		
		12.9	K	± 100	6	
			N	± 70		
		11.9	K	± 100	7	
			N	± 70		
		11.1	K	± 100	8	
			N	± 70		
		10.5	K	± 100	9	
			N	± 70		
		10	K	± 100	10	
			N	± 70		
		9.5	K	± 100	11	
			N	± 70		
		9.1	K	± 100	12	
			N	± 70		
		8.7	K	± 100	13	
			N	± 70		
	8.4	K	± 100	14		
		N	± 70			
	8.1	K	± 100	15		
N		± 70				

3.1.2 MLP series

Table-1(4)

Style	Rated dissipation (W)	Rated current (A)	Temperature coefficient of resistance ($10^{-6}/^{\circ}\text{C}$)		Rated resistance (m Ω)	Tolerance on rated resistance
MLP20	1.0	22.3	K	100	2	F($\pm 1\%$) J($\pm 5\%$)
			N	± 70		
		18.2	K	100	3	
			N	± 70		
		15.8	K	100	4	
			N	± 70		
		14.1	K	100	5	
			N	± 70		
		12.9	K	100	6	
			N	± 70		
		11.9	K	100	7	
			N	± 70		
		11.1	K	100	8	
			N	± 70		
10.5	K	100	9			
	N	± 70				
10	K	100	10			
	N	± 70				
MLP32	1.5	38.7	-(Standard)	± 150	1	F($\pm 1\%$) J($\pm 5\%$)
			N	± 70		
		27.3	K	± 100	2	
			N	± 70		
		22.3	K	± 100	3	
			N	± 70		
		19.3	K	± 100	4	
			N	± 70		
		17.3	K	± 100	5	
			N	± 70		
		15.8	K	± 100	6	
			N	± 70		
		14.6	K	± 100	7	
			N	± 70		
		13.6	K	± 100	8	
			N	± 70		
		12.9	K	± 100	9	
			N	± 70		
12.2	K	± 100	10			
	N	± 70				

Table-1(5)

Style	Rated dissipation (W)	Rated current (A)	Temperature coefficient of resistance ($10^{-6}/^{\circ}\text{C}$)		Rated resistance (m Ω)	Tolerance on rated resistance
MLP63	2.0	63.2	K	100	0.5	J($\pm 5\%$)
			N	± 70		
		36.5	K	100	1.5	F($\pm 1\%$) J($\pm 5\%$)
			N	± 70		
		31.6	K	100	2	
			N	± 70		
		28.2	K	100	2.5	
			N	± 70		
		25.8	K	100	3	
			N	± 70		
		22.3	K	100	4	
			N	± 70		
		20	K	100	5	
			N	± 70		
		18.2	K	100	6	
			N	± 70		
		16.9	K	100	7	
			N	± 70		
		15.8	K	100	8	
			N	± 70		
14.9	K	100	9			
	N	± 70				
14.1	K	100	10			
	N	± 70				

Style	Isolation voltage (V)	Category temperature range ($^{\circ}\text{C}$)
RLP16	100	-55--+155
RLP20		
RLP32		
RLP63		
MLP20		
MLP32		
MLP63		

3.2 Climatic category

55/155/56

Lower category temperature

 -55 $^{\circ}\text{C}$

Upper category temperature

 +155 $^{\circ}\text{C}$

Duration of the damp heat, steady state test

56days

3.3 Stability class

5%

Limits for change of resistance:

 -for long-term tests $\pm 5\%$

 -for short-term tests $\pm 1\%$

3.4 Derating

The derated values of dissipation at temperature in excess of 70 °C shall be as indicated by the following curve.

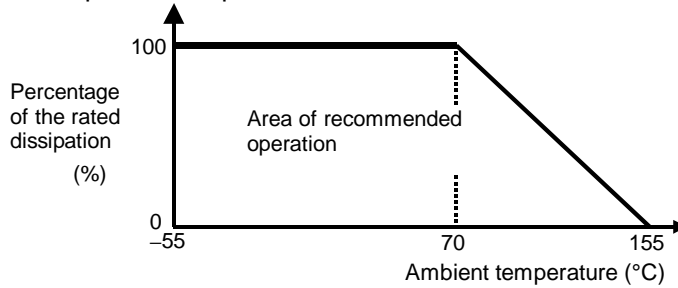

Figure-1 Derating curve

3.5 Rated voltage

d.c. or a.c. r.m.s. voltage calculated from the square root of the product of the rated resistance and the rated dissipation.

$$E = \sqrt{P \cdot R}$$

E: Rated voltage (V)
 P: Rated dissipation (W)
 R: Rated resistance (Ω)

3.6 Rated current

The rated current calculated from the square root of the quotient of the rated resistance and the rated dissipation.

$$I = \sqrt{P / R}$$

I: Rated current (A)
 P: Rated dissipation (W)
 R: Rated resistance (Ω)

The rated current shall be corresponding to rated voltage.

4. Packaging form

The standard packaging form shall be in accordance with Table-2.

Table-2

Symbol	Packaging form		Standard packaging quantity / units	Application
TP	Paper taping	8mm width, 4mm pitches	5,000 pcs.	RLP16, 20, 32, MLP20,32
TE	Embossed taping	12mm width, 4mm pitches	4,000 pcs.	RLP63, MLP63

5. Dimensions

5.1 The resistor shall be of the design and physical dimensions in accordance with Figure-2 and Table-3.

5.1.1 RLP series

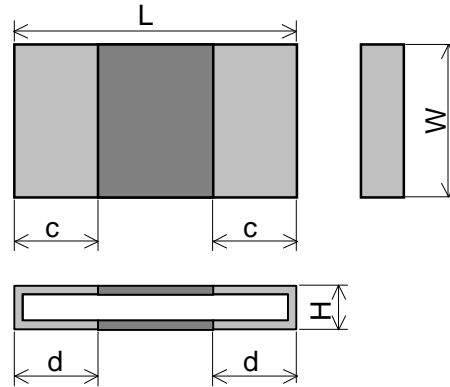

Figure-2
Table-3(1)

Unit: mm

Style	Rated resistance (mΩ)	L	W	H	c	d
RLP16	5	1.6±0.1	0.8±0.1	0.35±0.10	0.2±0.1	0.6±0.1
	10			0.3±0.1	0.2±0.1	0.3±0.1
RLP20	2	2.0±0.15	1.25±0.15	0.22±0.10	0.35±0.10	0.55±0.20
	3			0.45±0.10	0.35±0.10	0.75±0.20
	4			0.35±0.10	0.35±0.10	0.75±0.20
	5			0.35±0.10	0.35±0.10	0.6±0.2
	6			0.35±0.10	0.35±0.10	0.47±0.20
	7			0.22±0.10	0.35±0.10	0.75±0.20
	8			0.22±0.10	0.35±0.10	0.6±0.2
	9			0.22±0.10	0.35±0.10	0.52±0.20
	10			0.22±0.10	0.35±0.10	0.47±0.20
	RLP32			1	3.2±0.15	1.6±0.15
2		0.32±0.15	0.5±0.25	0.5±0.25		
3		0.35±0.10	0.7±0.25	1.3±0.25		
4		0.35±0.10	1.1±0.25	1.1±0.25		
5		0.35±0.10	1.0±0.25	1.0±0.25		
6		0.35±0.10	0.85±0.25	0.85±0.25		
7		0.35±0.10	0.7±0.25	0.7±0.25		
8		0.35±0.10	0.6±0.25	0.6±0.25		
9		0.3±0.1	0.75±0.25	0.75±0.25		
10		0.28±0.10	0.5±0.25	0.5±0.25		
11		0.28±0.10	0.5±0.25	0.5±0.25		
12		0.22±0.10	0.65±0.25	0.65±0.25		
13		0.22±0.10	0.65±0.25	0.65±0.25		
14		0.22±0.10	0.55±0.25	0.55±0.25		
15		0.22±0.10	0.5±0.25	0.5±0.25		

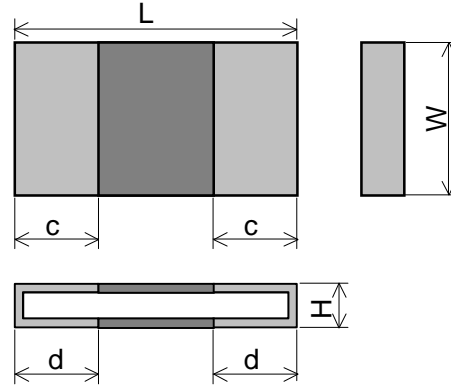

Table-3(2)

Unit: mm

Style	Rated resistance (mΩ)	L	W	H	c	d
RLP63	1	6.3±0.25	3.2±0.25	0.38±0.15	2.2±0.25	2.2±0.25
	2		3.1±0.25	0.38±0.15	1.1±0.25	1.1±0.25
	3			0.45±0.15	2.2±0.25	2.2±0.25
	4			0.35±0.15	2.2±0.25	2.2±0.25
	5			0.34±0.15	1.95±0.25	1.95±0.25
	6			0.34±0.15	1.75±0.25	1.75±0.25
	7			0.35±0.15	1.4±0.25	1.4±0.25
	8			0.35±0.15	1.1±0.25	1.1±0.25
	9			0.35±0.15	0.8±0.25	0.8±0.25
	10			0.23±0.15	1.75±0.25	1.75±0.25
	11			0.23±0.15	1.75±0.25	1.75±0.25
	12			0.23±0.15	1.4±0.25	1.4±0.25
	13			0.23±0.15	1.3±0.25	1.3±0.25
	14			0.23±0.15	1.1±0.25	1.1±0.25
	15			0.23±0.15	0.95±0.25	0.95±0.25

5.1.2 MLP series

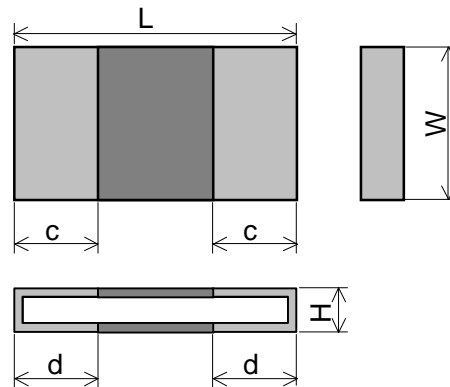

Table-3(3)

Unit: mm

Style	Rated resistance (mΩ)	L	W	H	c	d
MLP20	2	2.0±0.15	1.25±0.15	0.22±0.10	0.35±0.10	0.55±0.20
	3			0.45±0.10	0.35±0.10	0.75±0.20
	4			0.35±0.10	0.35±0.10	0.7±0.2
	5			0.35±0.10	0.35±0.10	0.6±0.2
	6			0.35±0.10	0.35±0.10	0.47±0.20
	7			0.22±0.10	0.35±0.10	0.75±0.20
	8			0.22±0.10	0.35±0.10	0.6±0.2
	9			0.22±0.10	0.35±0.10	0.52±0.20
	10			0.22±0.10	0.3±0.1	0.47±0.20
	MLP32			1	3.2±0.15	1.6±0.15
2		0.32±0.15	0.5±0.25	0.5±0.25		
3		0.35±0.10	0.7±0.25	1.3±0.25		
4		0.35±0.10	1.1±0.25	1.1±0.25		
5		0.35±0.10	1.0±0.25	1.0±0.25		
6		0.35±0.10	0.85±0.25	0.85±0.25		
7		0.35±0.10	0.7±0.25	0.7±0.25		
8		0.35±0.10	0.6±0.25	0.6±0.25		
9		0.3±0.1	0.75±0.25	0.75±0.25		
10		0.28±0.10	0.5±0.25	0.5±0.25		
MLP63	0.5	6.3±0.25	3.1±0.25	0.58±0.15	2.2±0.25	2.2±0.25
	1.5			0.38±0.15	1.5±0.25	1.5±0.25
	2			0.58±0.15	2.2±0.25	2.2±0.25
	2.5			0.45±0.15	2.4±0.25	2.4±0.25
	3			0.45±0.15	2.2±0.25	2.2±0.25
	4			0.34±0.15	2.2±0.25	2.2±0.25
	5			0.51±0.15	1.1±0.25	1.1±0.25
	6			0.5±0.15	1.1±0.25	1.1±0.25
	7			0.5±0.15	0.6±0.25	0.6±0.25
	8			0.35±0.15	1.1±0.25	1.1±0.25
9	0.35±0.15	0.8±0.25	0.8±0.25			
10	0.35±0.15	0.5±0.25	0.5±0.25			

5.2 Net weight (Reference)

Style	Rated resistance (mΩ)	Net weight (mg)
RLP16	5	2
	10	
RLP20	2,4 to 10	3
	3	7
RLP32	1	12
	2	11
	3	11
	4	12
	5	11
	6	11
	7	11
	8	10
	9	9
	10	9
	11	9
	12	8
	13	7
	14	7
	15	6
RLP63	1	50
	2	42
	3	57
	4	43
	5	43
	6	41
	7	42
	8	41
	9	40
	10	30
	11	30
	12	26
	13	26
	14	26
	15	26

5.2 Net weight (Reference)

Style	Rated resistance (mΩ)	Net weight (mg)
MLP20	2,4 to 10	3
	3	7
MLP32	1	12
	2	11
	3	11
	4	12
	5	11
	6	11
	7	11
	8	10
	9	9
	10	9
MLP63	0.5	90
	1.5	47
	2	77
	2.5	63
	3	63
	4	48
	5	64
	6	55
	7	55
	8	43
9	40	
10	41	

6. Marking

The Rated resistance of RLP16 should not be marked standard.

6.1 RLP63, MLP63

The rated resistance shall be marked in 4 characters consisting of 3 figures and a letter and marked on over coat side.

(Example) "R010" → 0.01 [Ω] → 10 [mΩ]

"1L50" → 0.0015 [Ω] → 1.5 [mΩ]

6.2 RLP20, 32, MLP20, 32

The rated resistance shall be marked in combination of two figures and underlines and marked on over coat side.

(Example) "05" → 0.005 [Ω] → 5 [mΩ]

"10" → 0.01 [Ω] → 10 [mΩ]

7. Performance

7.1 The standard condition for tests shall be in accordance with Sub-clause 4.2, JIS C 5201-1: 2011.

7.2 The performance shall be satisfied in Table-4.

Table- 4(1)

No.	Test items	Condition of test (JIS C 5201-1)	Performance requirements																																																																																					
1	Visual examination	Sub-clause 4.4.1 Checked by visual examination.	As in 4.4.1 The marking shall be legible, as checked by visual examination.																																																																																					
2	Dimension Resistance	Sub-clause 4.4.2 Resistance value shall be measured by mounting the substrate of the following condition.  <p style="text-align: right;">Unit:mm</p> <table border="1" style="width: 100%; border-collapse: collapse;"> <thead> <tr> <th>Style</th> <th>Resistance value(mΩ)</th> <th>a</th> <th>b</th> <th>c</th> </tr> </thead> <tbody> <tr> <td rowspan="2">RLP16</td> <td>5</td> <td>0.6</td> <td>0.9</td> <td rowspan="2">0.9</td> </tr> <tr> <td>10</td> <td>1.0</td> <td>0.6</td> </tr> <tr> <td rowspan="2">RLP20</td> <td>2,3</td> <td>0.5</td> <td>1.1</td> <td rowspan="2">1.36</td> </tr> <tr> <td>4 to 10</td> <td>0.8</td> <td>0.95</td> </tr> <tr> <td rowspan="5">RLP32</td> <td>1</td> <td>1.0</td> <td>1.45</td> <td rowspan="5">1.7</td> </tr> <tr> <td>2</td> <td>2.1</td> <td>0.9</td> </tr> <tr> <td>3</td> <td>0.8</td> <td>1.55</td> </tr> <tr> <td>4</td> <td>1.0</td> <td>1.45</td> </tr> <tr> <td>5 and 6</td> <td>1.4</td> <td>1.25</td> </tr> <tr> <td rowspan="4">RLP63</td> <td>1</td> <td>1.5</td> <td>3.0</td> <td rowspan="4">4.0</td> </tr> <tr> <td>2</td> <td>4.0</td> <td>1.8</td> </tr> <tr> <td>3, 4</td> <td>1.8</td> <td>2.9</td> </tr> <tr> <td>5</td> <td>2.4</td> <td>2.6</td> </tr> <tr> <td rowspan="2">MLP20</td> <td>2,3</td> <td>0.5</td> <td>1.1</td> <td rowspan="2">1.36</td> </tr> <tr> <td>4 to 10</td> <td>0.8</td> <td>0.95</td> </tr> <tr> <td rowspan="5">MLP32</td> <td>1</td> <td>1.0</td> <td>1.45</td> <td rowspan="5">1.7</td> </tr> <tr> <td>2</td> <td>2.1</td> <td>0.9</td> </tr> <tr> <td>3</td> <td>0.8</td> <td>1.55</td> </tr> <tr> <td>4</td> <td>1.0</td> <td>1.45</td> </tr> <tr> <td>5 and 6</td> <td>1.4</td> <td>1.25</td> </tr> <tr> <td rowspan="2">MLP63</td> <td>0.5,2 to 4</td> <td>1.8</td> <td>2.9</td> <td rowspan="2">3.5</td> </tr> <tr> <td>1.5, 5 to 10</td> <td>4.0</td> <td>1.8</td> </tr> </tbody> </table>	Style	Resistance value(mΩ)	a	b	c	RLP16	5	0.6	0.9	0.9	10	1.0	0.6	RLP20	2,3	0.5	1.1	1.36	4 to 10	0.8	0.95	RLP32	1	1.0	1.45	1.7	2	2.1	0.9	3	0.8	1.55	4	1.0	1.45	5 and 6	1.4	1.25	RLP63	1	1.5	3.0	4.0	2	4.0	1.8	3, 4	1.8	2.9	5	2.4	2.6	MLP20	2,3	0.5	1.1	1.36	4 to 10	0.8	0.95	MLP32	1	1.0	1.45	1.7	2	2.1	0.9	3	0.8	1.55	4	1.0	1.45	5 and 6	1.4	1.25	MLP63	0.5,2 to 4	1.8	2.9	3.5	1.5, 5 to 10	4.0	1.8	As specified in Table-3 of this specification. As in 4.5.2 The resistance value shall correspond with the rated resistance taking into account the specified tolerance.
Style	Resistance value(mΩ)	a	b	c																																																																																				
RLP16	5	0.6	0.9	0.9																																																																																				
	10	1.0	0.6																																																																																					
RLP20	2,3	0.5	1.1	1.36																																																																																				
	4 to 10	0.8	0.95																																																																																					
RLP32	1	1.0	1.45	1.7																																																																																				
	2	2.1	0.9																																																																																					
	3	0.8	1.55																																																																																					
	4	1.0	1.45																																																																																					
	5 and 6	1.4	1.25																																																																																					
RLP63	1	1.5	3.0	4.0																																																																																				
	2	4.0	1.8																																																																																					
	3, 4	1.8	2.9																																																																																					
	5	2.4	2.6																																																																																					
MLP20	2,3	0.5	1.1	1.36																																																																																				
	4 to 10	0.8	0.95																																																																																					
MLP32	1	1.0	1.45	1.7																																																																																				
	2	2.1	0.9																																																																																					
	3	0.8	1.55																																																																																					
	4	1.0	1.45																																																																																					
	5 and 6	1.4	1.25																																																																																					
MLP63	0.5,2 to 4	1.8	2.9	3.5																																																																																				
	1.5, 5 to 10	4.0	1.8																																																																																					
		Thickness of copper clad: 0.035mm 4-Terminal method Measurement current: 1(A) Note: The measuring apparatus corresponding to DC Low-ohm Mater (1A) of AX-1152D for ADEX CORPORATION.																																																																																						

Table-4(2)

No	Test items	Condition of test (JIS C 5201-1)	Performance requirements
3	Voltage proof	Sub-clause 4.7 Method: 4.6.1.4(See Figure-5) Test voltage: Alternating voltage with a peak value of 1.42 times the insulation voltage. Duration: 60 s±5 s Insulation resistance Test voltage: Insulation voltage Duration: 1 min.	No breakdown or flash over $R \geq 1 \text{ G}\Omega$
4	Solderability	Sub-clause 4.17 Without aging Flux: The resistors shall be immersed in a non-activated soldering flux for 2 s. Bath temperature: 235 °C±5 °C Immersion time: 2 s±0.5 s	As in 4.17.4.5 The terminations shall be covered with a smooth and bright solder coating.
5	Mounting Overload (in the mounted state) Solvent resistance of the marking	Sub-clause 4.31 Substrate material: Epoxide woven glass Test substrate: RLP16: Figure-3-1 RLP20, MLP20 Figure-3-2 RLP32 MLP32 Figure-3-3 RLP63, MLP63 Figure-3-4 Sub-clause 4.13 The applied voltage shall be 2.5 times the rated voltage or the current corresponding to. Duration: 2 s Visual examination Resistance Sub-clause 4.30 Solvent: 2-propanol Solvent temperature: 23 °C±5 °C Method 1 Rubbing material: cotton wool Without recovery	No visible damage $\Delta R \leq \pm 1\%$ Legible marking
6	Mounting Bound strength of the end face plating Final measurements	Sub-clause 4.31 Substrate material: Epoxide woven glass Test substrate: Figure-4 Sub-clause 4.33 Bent value: 3mm(RLP16, 20, 32, MLP20, 32) 1 mm(RLP63, MLP63) Resistance Sub-clause 4.33.6 Visual examination	$\Delta R \leq \pm 1\%$ No visible damage

Table-4(3)

No	Test items	Condition of test (JIS C 5201-1)	Performance requirements
7	Resistance to soldering heat Component resistance solvent	Sub-clause 4.18 (JEITA RC-2144 2.3.2) Substrate material: Epoxide woven glass Test substrate: Figure-3-1 T ₁ :Pre-heat minimum temp.:150±5 °C T ₂ :Pre-heat maximum temp.:180±5 °C T ₃ :Soldering temp.:220 °C T ₄ :Peak temp.:250 °C t ₁ :Pre-heat duration:120±5 s t ₂ :Soldering duration:60 to 90 s t ₃ :Peak duration(T ₄ -5°C):20 to 40 s Pre-reflow soldering: 1 time (Initial measurements) Reflow soldering: 3 times  Visual examination Resistance Sub-clause 4.29 Solvent: 2-propanol Solvent temperature: 23 °C±5 °C Method 2 Recovery: 48 h Visual examination Resistance	No visible damage $\Delta R \leq \pm 1\%$ No visible damage $\Delta R \leq \pm 1\%$
8	Mounting Adhesion Rapid change temperature	Sub-clause 4.31 Substrate material: Epoxide woven glass Test substrate: Figure-3-1 Sub-clause 4.32 Force: 5 N Duration: 10 s±1 s Visual examination Sub-clause 4.19 Lower category temperature:-55 °C Upper category temperature:+155 °C Duration of exposure at each temperature: 30 min. Number of cycles: 5 cycles. Visual examination Resistance	No visible damage No visible damage $\Delta R \leq \pm 1\%$

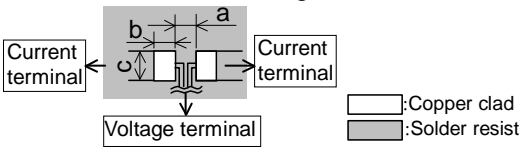
Table-4(4)

No	Test items	Condition of test (JIS C 5201-1)	Performance requirements
9	Climatic sequence -Dry heat -Damp heat, cycle (12+12hour cycle) First cycle -Cold -Damp heat, cycle (12+12hour cycle) Remaining cycle -D.C. load	Sub-clause 4.23 Sub-clause 4.23.2 Test temperature: +155 °C Duration: 16 h Sub-clause 4.23.3 Test method: 2 Test temperature: 55 °C [Severity(2)] Sub-clause 4.23.4 Test temperature -55 °C Duration: 2h Sub-clause 4.23.6 Test method: 2 Test temperature: 55 °C [Severity (2)] Number of cycles: 5 cycles Sub-clause 4.23.7 The applied current shall be the rated current. Duration: 1 min. Visual examination Resistance	No visible damage $\Delta R \leq \pm 5 \%$
10	Mounting Endurance at 70 °C	Sub-clause 4.31 Substrate material: Epoxide woven glass Test substrate: RLP16: Figure-3-1 RLP20, MLP20 Figure-3-2 RLP32 MLP32 Figure-3-3 RLP63, MLP63 Figure-3-4 Sub-clause 4.25.1 Ambient temperature: 70 °C±2 °C Duration: 1000 h The current shall be applied in cycles of 1.5 h on and 0.5 h. The applied current shall be the rated current Examination at 48 h, 500 h and 1000 h: Visual examination Resistance	No visible damage $\Delta R \leq \pm 5 \%$
11	Mounting Variation of resistance with temperature	Sub-clause 4.31 Substrate material: Epoxide woven glass Test substrate: Figure-3-1 Sub-clause 4.8 +20 °C / +155 °C	As in Table-1

Table-4(5)

No	Test items	Condition of test (JIS C 5201-1)	Performance requirements
12	Mounting Damp heat, steady state	Sub-clause 4.31 Substrate material: Epoxide woven glass Test substrate: Figure-3-1 Sub-clause 4.24 Ambient temperature: 40 °C±2 °C Relative humidity: 93 ⁺² / ₃ % Without current applied. Visual examination Resistance	No visible damage Legible marking $\Delta R \leq \pm 5\%$
13	Dimensions (detail) Mounting Endurance at upper category temperature	Sub-clause 4.4.3 Sub-clause 4.31 Substrate material: Epoxide woven glass Test substrate: Figure-3-1 Sub-clause 4.25.3 Ambient temperature: 155 °C±2 °C Duration: 1000 h Examination at 48 h, 500 h and 1000 h: Visual examination Resistance	As in Table-4 No visible damage $\Delta R \leq \pm 5\%$

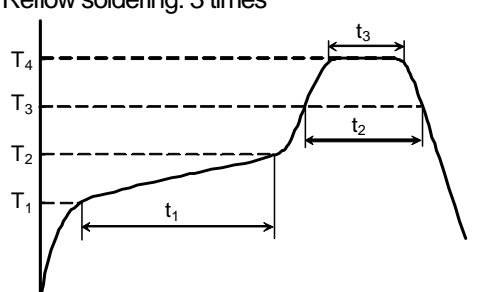
8. Test substrate

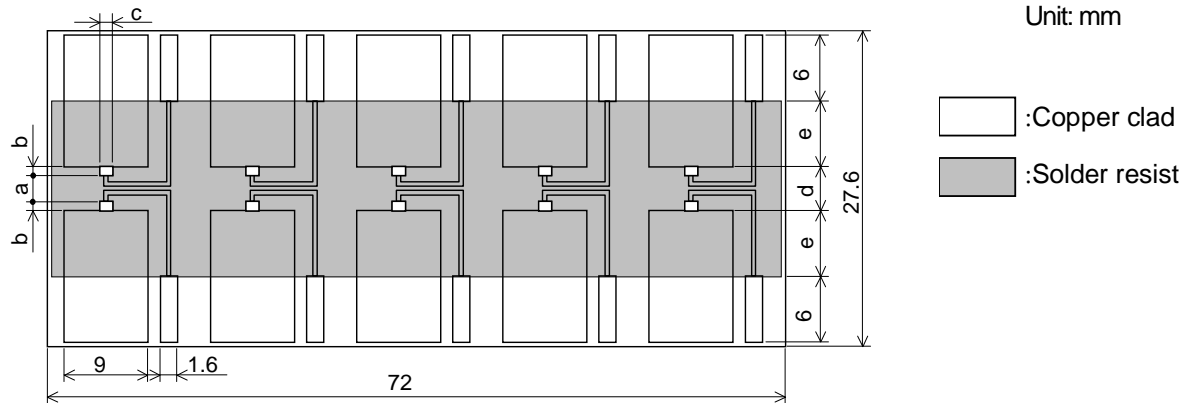

Style	Rated resistance (mΩ)	a	b	c	d	e
RLP16	5	0.6	0.9	0.9	2.2	6.2
	10	1.0	0.6			
RLP20	2,3	0.5	1.1	1.36	2.7	5.95
	4 to 10	0.8	0.95			
RLP32	1	1.0	1.45	1.7	3.9	5.35
	2	2.1	0.9			
	3	0.8	1.55			
	4	1.0	1.45			
	5 and 6	1.4	1.25			
	7 to 15	2.1	0.9			
RLP63	1	1.5	3.05	3.5	7.6	3.5
	2	4.0	1.8			
	3, 4	1.8	2.9			
	5	2.4	2.6			
	6 to 15	4.0	1.8			
MLP20	2,3	0.5	1.1	1.36	2.7	5.95
	4 to 10	0.8	0.95			
MLP32	1	1.0	1.45	1.7	3.9	5.35
	2	2.1	0.9			
	3	0.8	1.55			
	4	1.0	1.45			
	5 and 6	1.4	1.25			
	7 to 10	2.1	0.9			
MLP63	0.5, 2 to 4	1.8	2.9	3.5	7.6	3.5
	1.5, 5 to 10	4.0	1.8			

Figure-3-1 RLP16, 20, 32, 63, MLP20,32, 63 TEST SUBSTRATE

Remark: Material: Epoxy resin based as glass fabric(Specified in JIS C 6484).

Thickness: 1.6mm Thickness of copper clad: 0.035mm

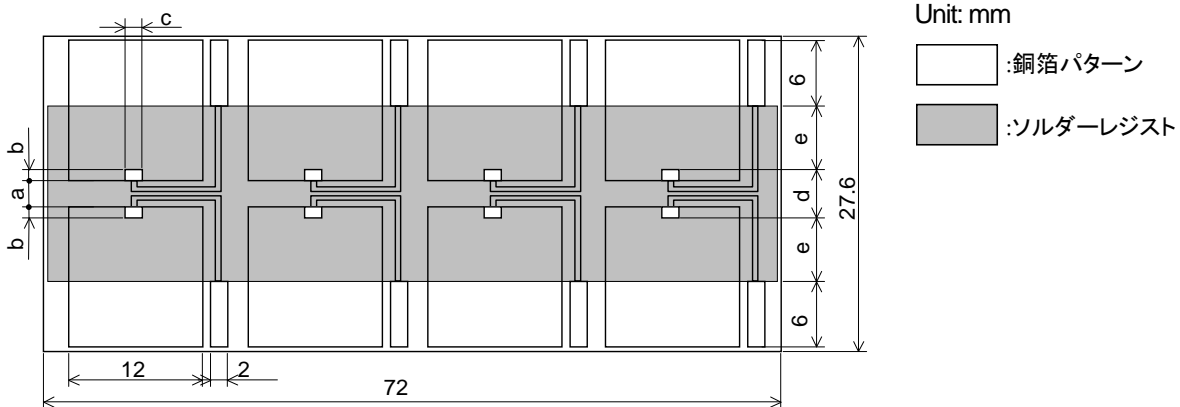

Style	Rated resistance (mΩ)	a	b	c	d	e
RLP20	2,3	0.5	1.1	1.36	2.7	5.95
	4 to 10	0.8	0.95			
MLP20	2,3	0.5	1.1			
	4 to 10	0.8	0.95			

Figure-3-2 RLP20, MLP20 TEST SUBSTRATE

Remark: Material: Epoxy resin based as glass fabric(Specified in JIS C 6484).

Thickness: 1.6mm Thickness of copper clad: 0.035mm

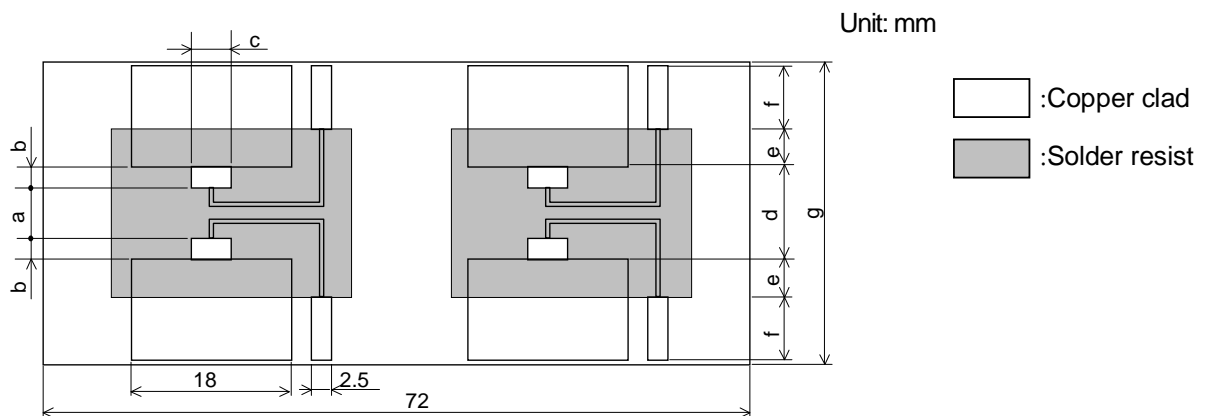

Style	Rated resistance (mΩ)	a	b	c	d	e	f	g
RLP32	1	1.0	1.45	1.7	3.9	5.35	11.68	39
	2	2.1	0.9				6.0	27.6
	3	0.8	1.55				11.68	39
	4	1.0	1.45				6.0	27.6
	5 and 6	1.4	1.25				11.68	39
	7 to 15	2.1	0.9				6.0	27.6
MLP32	1	1.0	1.45	1.7	3.9	5.35	11.68	39
	2	2.1	0.9				6.0	27.6
	3	0.8	1.55				11.68	39
	4	1.0	1.45				6.0	27.6
	5 and 6	1.4	1.25				11.68	39
	7 to 10	2.1	0.9				6.0	27.6

Figure-3-3 RLP32, MLP32 TEST SUBSTRATE

Remark: Material: Epoxy resin based as glass fabric(Specified in JIS C 6484).

Thickness: 1.6mm Thickness of copper clad: 0.07mm

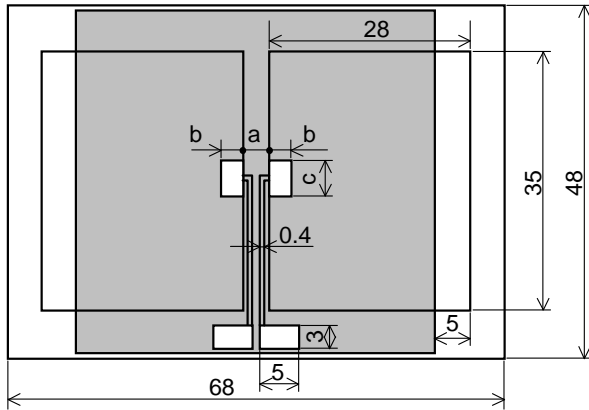

Unit: mm

:Copper clad
 :Solder resist

Style	Rated resistance (mΩ)	a	b	c
RLP63	1	2.0	3.0	4.0
	2	4.0	1.8	3.5
	3, 4	1.8	2.9	
	5	2.4	2.6	
	6 to 15	4.0	1.8	
MLP63	0.5, 2 to 4	1.8	2.9	3.5
	1.5, 5 to 10	4.0	1.8	

Figure-3-4 RLP63, MLP63 TEST SUBSTRATE

Remark: Material: Epoxy resin based as glass fabric(Specified in JIS C 6484).

Thickness: 1.6mm Thickness of copper clad: 0.07mm

Remark: In the case of connection by connector, the connecting terminals are gold plated.

However, the plating is not necessary when the connection is made by soldering.

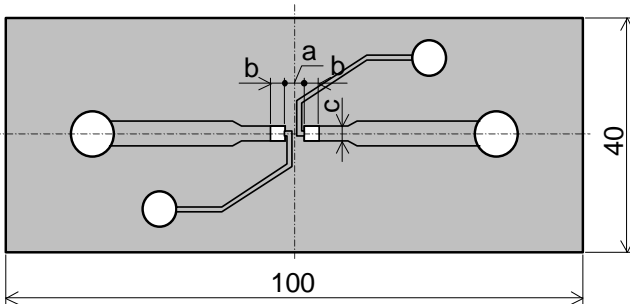

Unit: mm

:Copper clad
 :Solder resist

Style	Rated resistance (mΩ)	a	b	c
RLP16	5	0.6	0.9	0.9
	10	1.0	0.6	
RLP20	2,3	0.5	1.1	1.36
	4 to 10	0.8	0.95	
RLP32	1	1.0	1.45	1.7
	2	2.1	0.9	
	3	0.8	1.55	
	4	1.0	1.45	
	5 and 6	1.4	1.25	
MLP20	7 to 15	2.1	0.9	1.36
	2,3	0.5	1.1	
	4 to 10	0.8	0.95	
MLP32	1	1.0	1.45	1.7
	2	2.1	0.9	
	3	0.8	1.55	
	4	1.0	1.45	
	5 and 6	1.4	1.25	
	7 to 10	2.1	0.9	

RLP16, 20, 32, MLP20 32 BOUND STRENGTH OF THE END FACE PLATING TEST SUBSTRATE

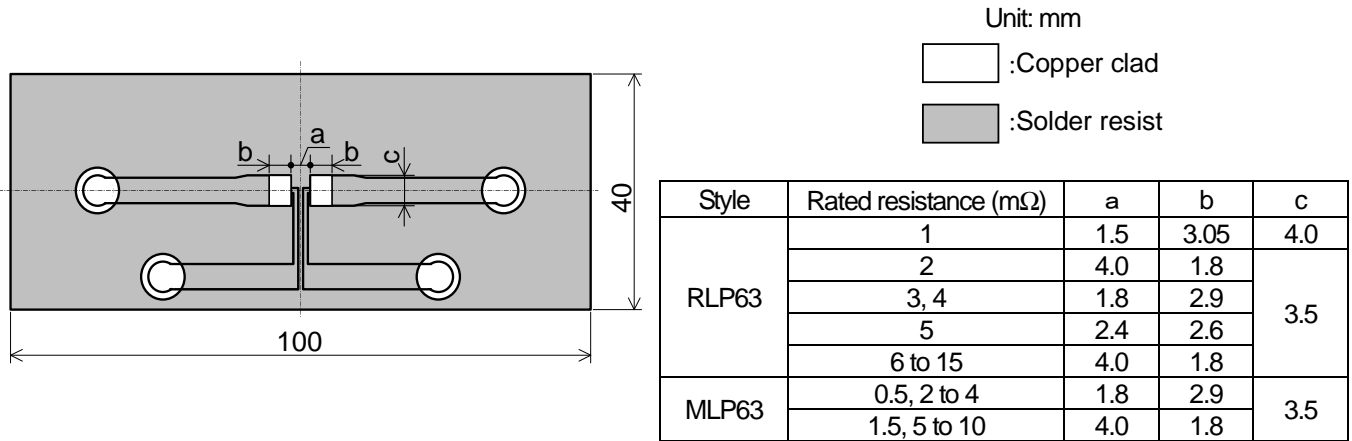

RLP 63, MLP63 BOUND STRENGTH OF THE END FACE PLATING TEST SUBSTRATE

Figure-4

Remark. Material: Epoxy resin based as glass fabric(Specified in JIS C 6484).

Thickness: 1.6mm Thickness of copper clad: 0.035mm

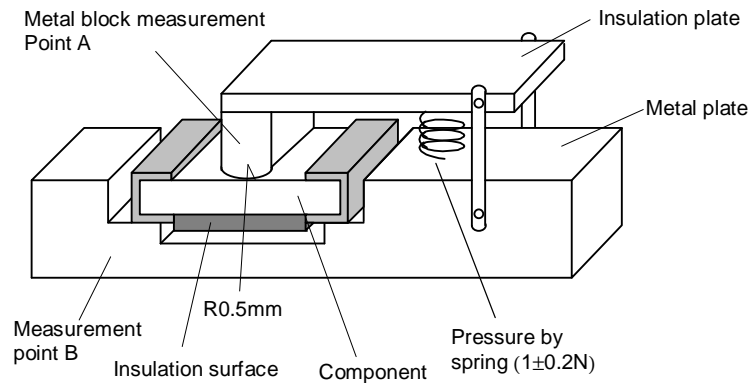

Figure-5

9. Taping

9.1 Applicable documents JIS C 0806-3: 2014, EIAJ ET-7200C: 2010

9.2 Taping dimensions

9.2.1 Paper taping (8mm width, 4mm pitches)

Taping dimensions shall be in accordance with Figure-6 and Table-5.

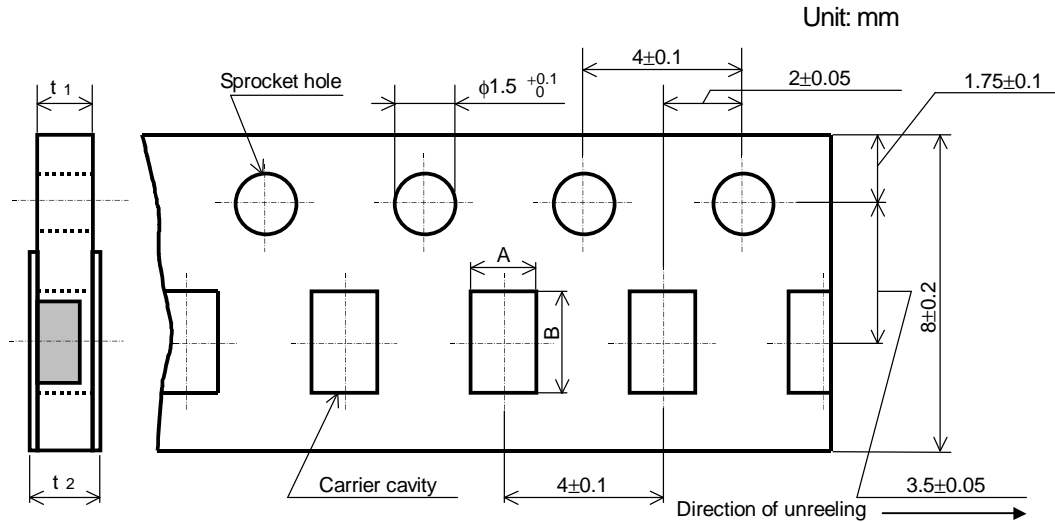

Figure-6

Table-5

Unit: mm

Style	A	B	t ₁	t ₂
RLP16	1.15±0.15	1.9 ± 0.2	0.6±0.1	0.8max.
RLP20	1.65±0.15	2.5±0.2	0.6±0.1	0.8max.
MLP20				
RLP32	2.00±0.15	3.6±0.2	0.6±0.1	0.8max.
MLP32				

9.2.2 Embossed taping (12mm width, 4mm pitches)

Taping dimensions shall be in accordance with Figure-7 and Table-6.

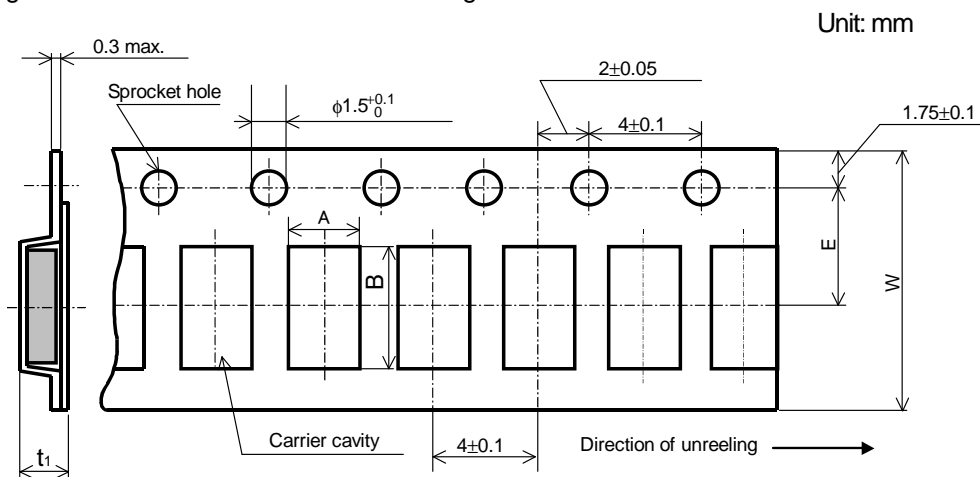

Figure-7

Table-6

Unit: mm

Style	A	B	W	E	t ₁
RLP63	3.6±0.2	6.9±0.2	12.0±0.3	5.5±0.05	1.1±0.15
MLP63					

- 1). The cover tapes shall not cover the sprocket holes.
- 2). Tapes in adjacent layers shall not stick together in the packing.
- 3). Components shall not stick to the carrier tape or to the cover tape.
- 4). Pitch tolerance over any 10 pitches $\pm 0.2\text{mm}$.
- 5). The peel strength of the top cover tape shall be within 0.1N to 0.5N on the test method as shown in the following RLP16, 20, 32, MLP20, 32: Figure-8, RLP63, MLP63: Figure-9.
- 6). When the tape is bent with the minimum radius for (RLP16, 20, 32, MLP20, 32: 25mm, RLP63, MLP63 : 30mm) the tape shall not be damaged and the components shall maintain their position and orientation in the tape.
- 7). In no case shall there be two or more consecutive components missing.
The maximum number of missing components shall be one or 0.1%, whichever is greater.

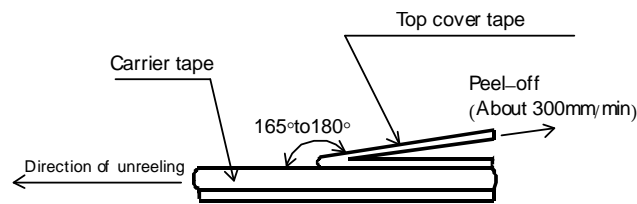

Figure-8

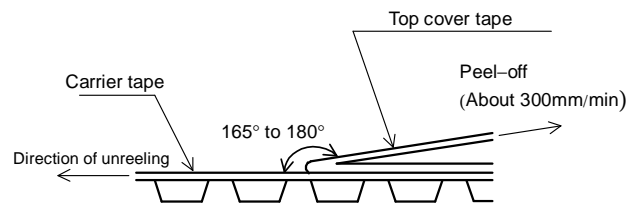

Figure-9

9.3 Reel dimension

Reel dimensions shall be in accordance with the following Figure-10 and Table-7.
 Plastic reel (Based on EIAJ ET-7200C)

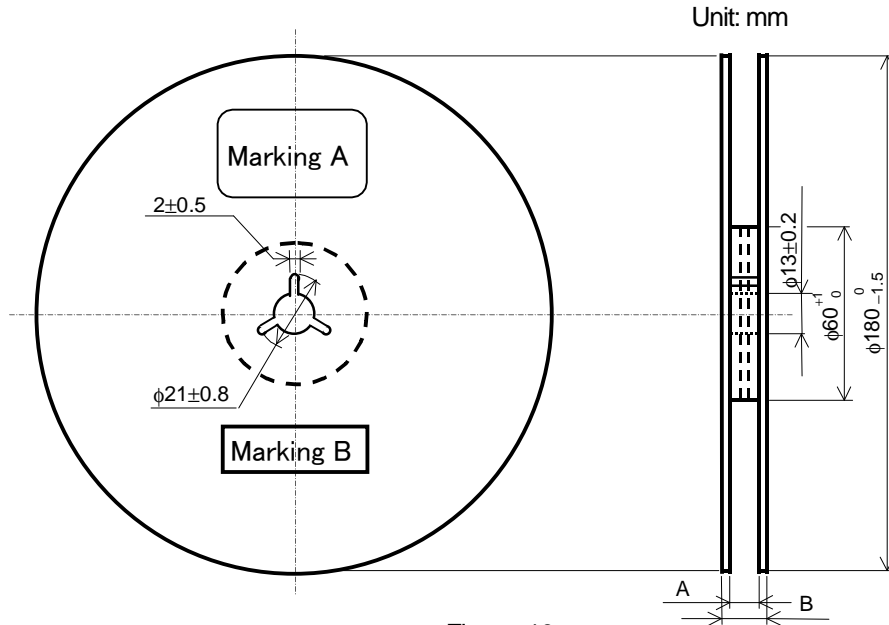

Figure-10

Table-7

Style	A	B	Unit: mm
			Note
RLP16, 20, 32, MLP20,32	9 ^{+1.0} / ₀	11.4±1.0	Injection molding
		13±1.0	Vacuum forming
RLP63, MLP63	13 ^{+1.0} / ₀	17±1.0	Vacuum forming

Note : Marking label shall be marked on a place of Marking A or two place of Marking A and B.

9.4 Leader and trailer tape.

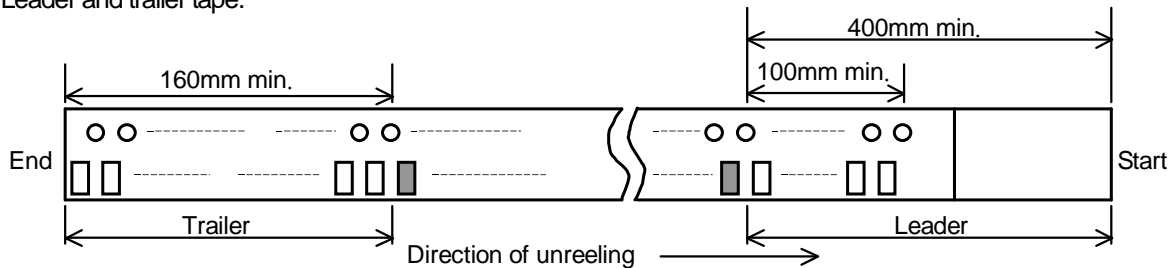

Figure-11

10. Marking on package

The label of a minimum package shall be legibly marked with follows.

10.1 Marking A

(1) Classification

(Style, Temperature coefficient of resistance, Rated resistance, Tolerance on rated resistance, Packaging form)

(2) Lot number (3) Quantity (4) Manufacturer's name or trade mark (5) Others

10.2 Marking B (KAMAYA Control label)

单击下面可查看定价，库存，交付和生命周期等信息

[>>Kamaya\(釜屋电机\)](#)