

CONSTANT VOLTAGE REGULATION APPLICATION.  
REFERENCE VOLTAGE APPLICATION.

### FEATURES

- Small Package : USC
- Zener Voltage Tolerance
  - None Grade : About  $\pm 6\%$ .
  - Y Grade : About  $\pm 2.5\%$ .
- Suffix U : Qualified to AEC-Q101.  
ex) KDZ10V-Y-RTK/HU
- Suffix A : USC(1) Package  
ex) KDZ12V-Y-RTK/HA

### MAXIMUM RATING (Ta=25°C)

CHARACTERISTIC	SYMBOL	RATING	UNIT
Power Dissipation	$P_D^*$	200	mW
Junction Temperature	$T_j$	150	°C
Operating Temperature	$T_{opr}$	-55 ~ 150	°C
Storage Temperature Range	$T_{stg}$	-55 ~ 150	°C

\* Mounted on a glass epoxy circuit board of  $20 \times 20$ mm, pad dimension of  $4 \times 4$ mm.

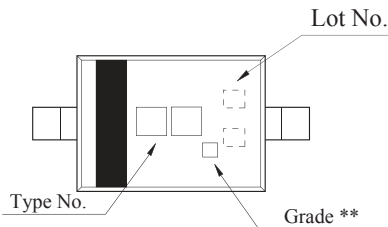

\*\*

Grade	Symbol
None	(Blank)
Y	●

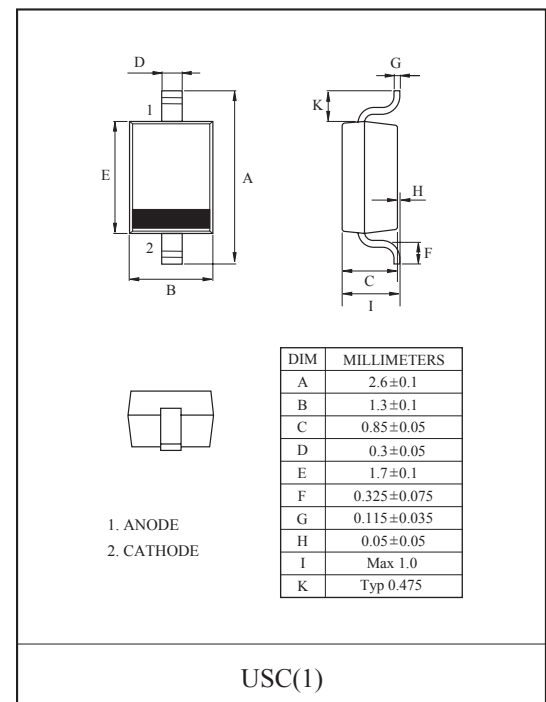
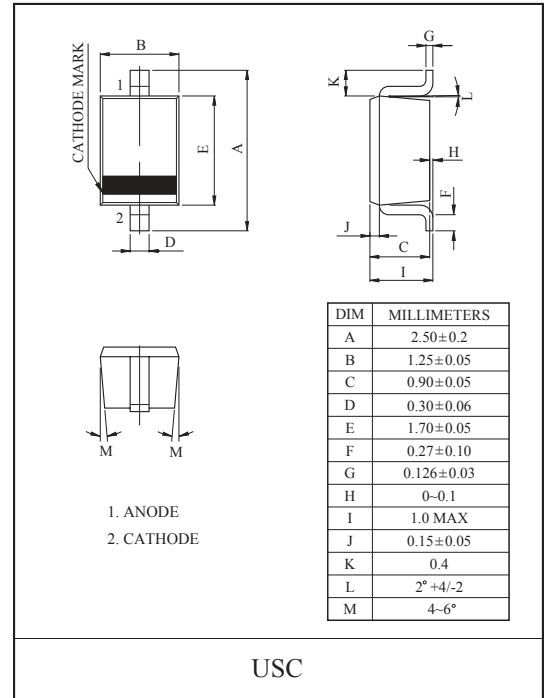

Type No.	Marking	Type No.	Marking	Type No.	Marking	Type No.	Marking
KDZ2.0V	2A	KDZ4.3V	43	KDZ9.1V	91	KDZ20V	20
KDZ2.2V	2B	KDZ4.7V	47	KDZ10V	10	KDZ22V	22
KDZ2.4V	2C	KDZ5.1V	51	KDZ11V	11	KDZ24V	24
KDZ2.7V	2D	KDZ5.6V	56	KDZ12V	12	KDZ27V	A1
KDZ3.0V	30	KDZ6.2V	62	KDZ13V	13	KDZ30V	A2
KDZ3.3V	33	KDZ6.8V	68	KDZ15V	15	KDZ33V	A3
KDZ3.6V	36	KDZ7.5V	75	KDZ16V	16	KDZ36V	7
KDZ3.9V	39	KDZ8.2V	82	KDZ18V	18	-	-

# KDZ2.0V~36V

## ELECTRICAL CHARACTERISTICS (T<sub>a</sub>=25 °C)

TYPE No.	Grade	Zener Voltage V <sub>z</sub> (V)			Dynamic Impedance Z <sub>z</sub> (Ω)		KNEE Dynamic Impedance Z <sub>zk</sub> (Ω)		Reverse Current I <sub>R</sub> (μA)	
		Min.	Max.	I <sub>z</sub> (mA)	MAX.	I <sub>z</sub> (mA)	MAX.	I <sub>z</sub> (mA)	MAX.	V <sub>R</sub> (V)
KDZ2.0V	-	1.85	2.15	5	100	5	1000	0.5	120	1.0
	Y	1.95	2.15							
KDZ2.2V	-	2.05	2.38	5	100	5	1000	0.5	120	1.0
	Y	2.16	2.38							
KDZ2.4V	-	2.28	2.60	5	100	5	1000	0.5	120	1.0
	Y	2.40	2.60							
KDZ2.7V	-	2.50	2.90	5	110	5	1000	0.5	120	1.0
	Y	2.65	2.90							
KDZ3.0V	-	2.80	3.20	5	120	5	1000	0.5	50	1.0
	Y	2.95	3.20							
KDZ3.3V	-	3.10	3.50	5	130	5	1000	0.5	20	1.0
	Y	3.25	3.50							
KDZ3.6V	-	3.40	3.80	5	130	5	1000	0.5	10	1.0
	Y	3.60	3.845							
KDZ3.9V	-	3.70	4.10	5	130	5	1000	0.5	10	1.0
	Y	3.890	4.160							
KDZ4.3V	-	4.00	4.50	5	130	5	1000	0.5	5	1.0
	Y	4.170	4.430							
KDZ4.7V	-	4.40	4.90	5	120	5	1000	0.5	5	1.0
	Y	4.550	4.750							
KDZ5.1V	-	4.80	5.40	5	70	5	1000	0.5	1	1.5
	Y	4.980	5.200							
KDZ5.6V	-	5.30	6.00	5	40	5	900	0.5	1	2.5
	Y	5.490	5.730							
KDZ6.2V	-	5.80	6.60	5	30	5	500	0.5	1	3.0
	Y	6.060	6.330							
KDZ6.8V	-	6.40	7.20	5	25	5	150	0.5	0.5	5.0
	Y	6.650	6.930							
KDZ7.5V	-	7.00	7.90	5	23	5	120	0.5	0.5	6.0
	Y	7.280	7.600							
KDZ8.2V	-	7.70	8.70	5	20	5	120	0.5	0.5	6.5
	Y	8.020	8.360							
KDZ9.1V	-	8.50	9.60	5	18	5	120	0.5	0.5	7.0
	Y	8.850	9.230							
KDZ10V	-	9.40	10.60	5	15	5	120	0.5	0.5	8.0
	Y	9.770	10.210							

# KDZ2.0V~36V

## ELECTRICAL CHARACTERISTICS (Continuous, Ta=25°C)

TYPE No.	Grade	Zener Voltage Vz (V)			Dynamic Impedance Zz (Ω)		KNEE Dynamic Impedance Zzk (Ω)		Reverse Current IR (μA)	
		Min.	Max.	Iz (mA)	MAX.	Iz (mA)	MAX.	Iz (mA)	MAX.	VR(V)
KDZ11V	-	10.40	11.60	5	15	5	120	0.5	0.5	8.5
	Y	10.760	11.220							
KDZ12V	-	11.40	12.60	5	15	5	110	0.5	0.5	9.0
	Y	11.740	12.240							
KDZ13V	-	12.40	14.10	5	15	5	110	0.5	0.5	10
	Y	12.910	13.490							
KDZ15V	-	13.80	15.60	5	15	5	110	0.5	0.5	11
	Y	14.340	14.980							
KDZ16V	-	15.30	17.10	5	18	5	150	0.5	0.5	12
	Y	15.850	16.510							
KDZ18V	-	16.80	19.10	5	20	5	150	0.5	0.5	14
	Y	17.560	18.350							
KDZ20V	-	18.80	21.20	5	25	5	200	0.5	0.5	15
	Y	19.520	20.390							
KDZ22V	-	20.80	23.30	5	30	5	200	0.5	0.5	17
	Y	21.540	22.470							
KDZ24V	-	22.80	25.60	5	40	5	200	0.5	0.5	19
	Y	23.720	24.780							
KDZ27V	-	26.19	27.53	2	150	2	150	0.5	0.1	21
KDZ30V	-	29.19	30.69		200		200			23
KDZ33V	-	32.15	33.79		250		250			25
KDZ36V	-	35.07	36.87		300		300			27

# KDZ2.0V~36V

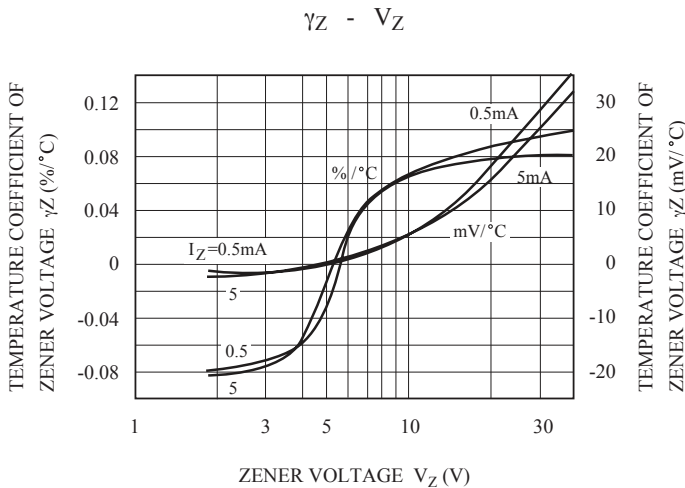
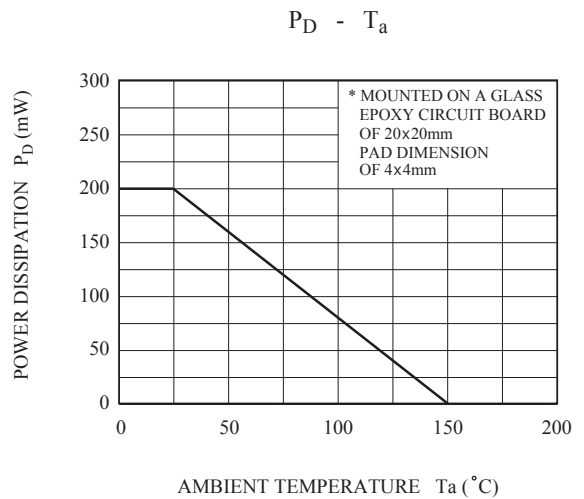
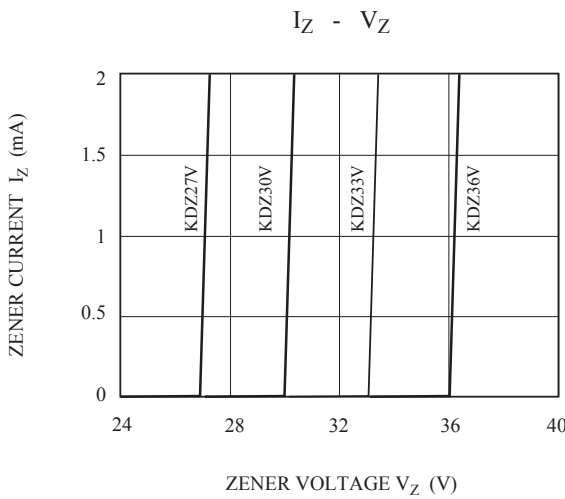
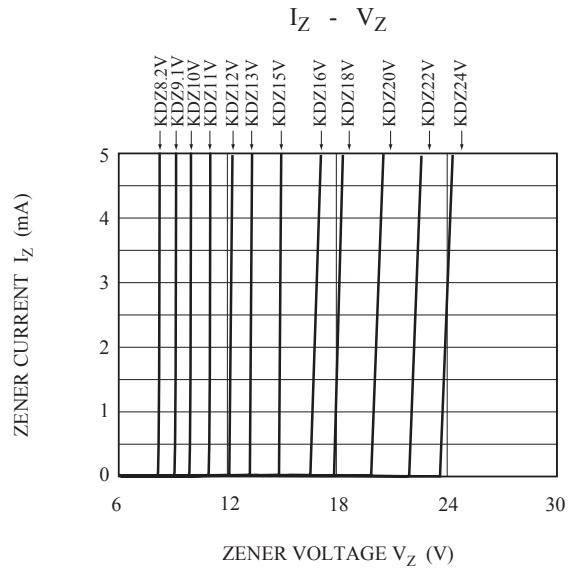
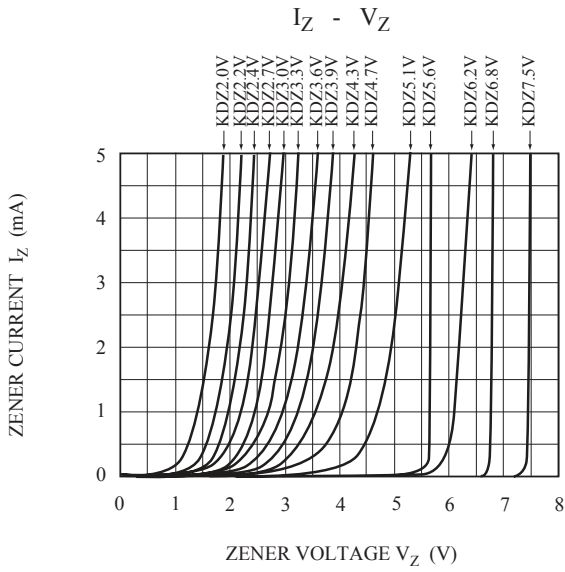

单击下面可查看定价，库存，交付和生命周期等信息

[>>KEC\(开益禧\)](#)