

GENERAL PURPOSE APPLICATION.
SWITCHING APPLICATION.

FEATURES

- Excellent h_{FE} Linearity
 : $h_{FE}(2)=80(\text{Typ.})$ at $V_{CE}=-6V, I_C=-150\text{mA}$
 : $h_{FE}(I_C=0.1\text{mA})/h_{FE}(I_C=2\text{mA})=0.95(\text{Typ.})$.
- Low Noise : $NF=1\text{dB}(\text{Typ.})$ at $f=1\text{kHz}$.
- Complementary to KTC3198.

MAXIMUM RATING ($T_a=25^\circ\text{C}$)

CHARACTERISTIC	SYMBOL	RATING	UNIT
Collector-Base Voltage	V_{CBO}	-50	V
Collector-Emitter Voltage	V_{CEO}	-50	V
Emitter-Base Voltage	V_{EBO}	-5	V
Collector Current	I_C	-150	mA
Base Current	I_B	-50	mA
Collector Power Dissipation	$*P_C$	625	mW
		400	
Junction Temperature	T_j	150	$^\circ\text{C}$
Storage Temperature Range	T_{stg}	-55 ~ 150	$^\circ\text{C}$

*Cu Lead-Frame : 625mW
Fe Lead-Frame : 400mW

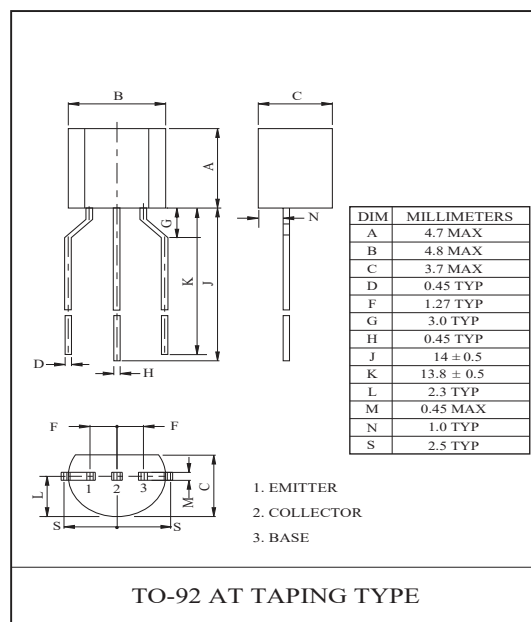
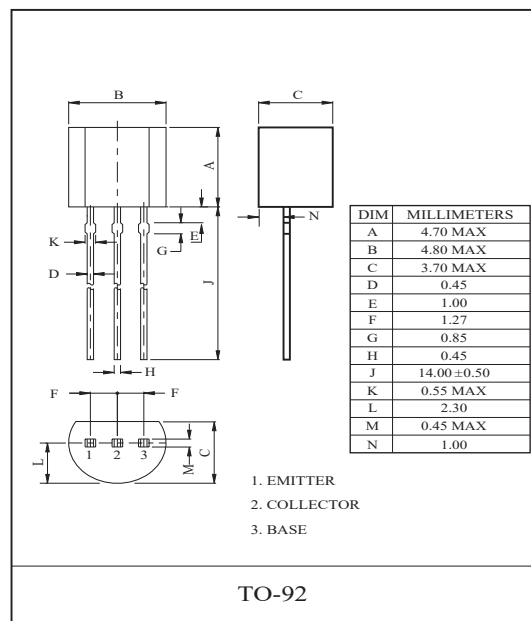

ELECTRICAL CHARACTERISTICS ($T_a=25^\circ\text{C}$)

CHARACTERISTIC	SYMBOL	TEST CONDITION	MIN.	TYP.	MAX.	UNIT
Collector Cut-off Current	I_{CBO}	$V_{CB}=-50V, I_E=0$	-	-	-0.1	μA
Emitter Cut-off Current	I_{EBO}	$V_{EB}=-5V, I_C=0$	-	-	-0.1	μA
DC Current Gain	$h_{FE}(1)$ (Note)	$V_{CE}=-6V, I_C=-2\text{mA}$	70	-	400	
	$h_{FE}(2)$	$V_{CE}=-6V, I_C=-150\text{mA}$	25	-	-	
Collector-Emitter Saturation Voltage	$V_{CE(sat)}$	$I_C=-100\text{mA}, I_B=-10\text{mA}$	-	-0.1	-0.3	V
Base-Emitter Saturation Voltage	$V_{BE(sat)}$	$I_C=-100\text{mA}, I_B=-10\text{mA}$	-	-	-1.1	V
Transition Frequency	f_T	$V_{CE}=-10V, I_C=-1\text{mA}$	80	-	-	MHz
Collector Output Capacitance	C_{ob}	$V_{CB}=-10V, I_E=0, f=1\text{MHz}$	-	4.0	7.0	pF
Base Intrinsic Resistance	$r_{bb'}$	$V_{CB}=-10V, I_E=1\text{mA}, f=30\text{MHz}$	-	30	-	Ω
Noise Figure	NF	$V_{CE}=-6V, I_C=-0.1\text{mA}, R_g=10k\Omega, f=1\text{kHz}$	-	1.0	10	dB

Note : $h_{FE}(1)$ Classification O:70 ~ 140, Y:120 ~ 240, GR:200 ~ 400

KTA1266

$I_C - V_{CE}$

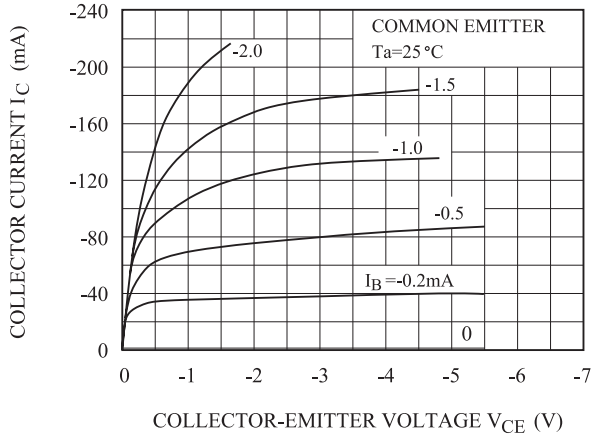

$h_{FE} - I_C$

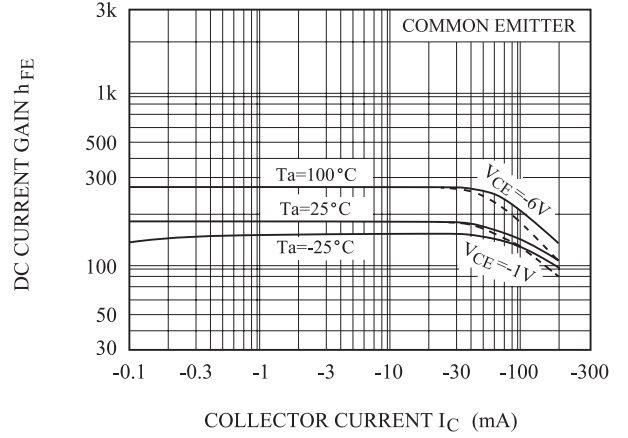

$V_{CE(sat)} - I_C$

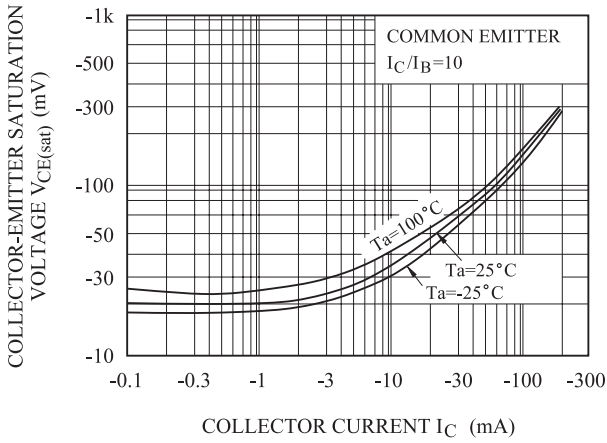

$f_T - I_C$

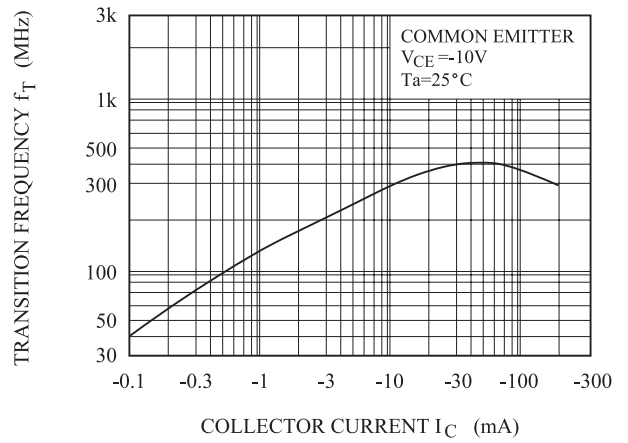

$I_B - V_{BE}$

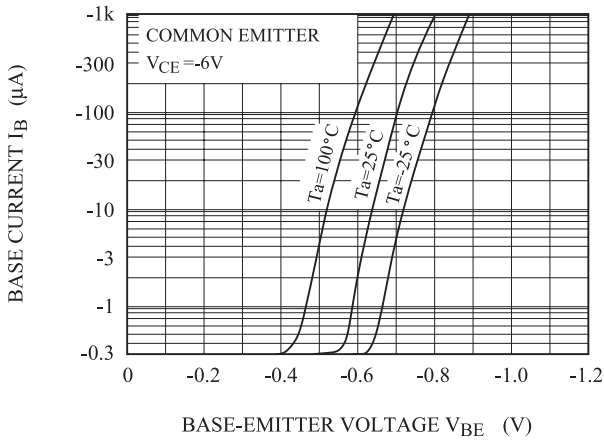

$P_C - T_a$

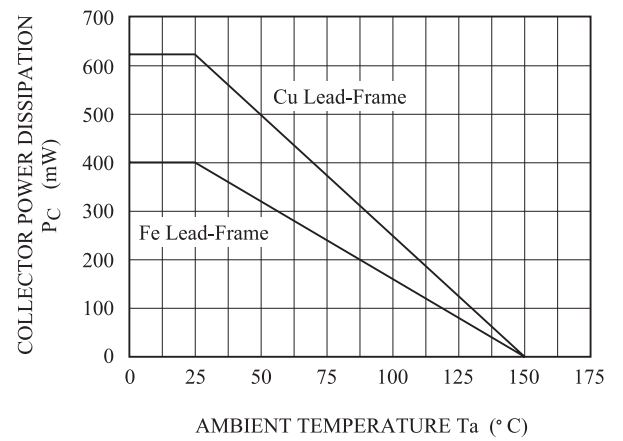

单击下面可查看定价，库存，交付和生命周期等信息

[>>KEC\(开益禧\)](#)