

Metallized Polypropylene Film EMI Suppression Capacitors

R47 Series, Class X2, 440 VAC, 110°C

(Automotive Grade)

Overview

The R47 series is constructed of metallized polypropylene film encapsulated with self-extinguishing resin in a box of material that meets the requirements of UL 94 V-0.

Automotive Grade devices (up to 22.5 mm lead spacing) meet the demanding Automotive Electronics Council's AEC-Q200 qualification requirements.

Applications

For worldwide use in electromagnetic interference (EMI) suppression in across-the-line applications that require X2 safety classification. Intended for use in situations in which capacitor failure would not result in exposure to electric shock.

Benefits

- Approvals: ENEC, UL, cUL
- X2 CLASS (IEC 60384-14)
- Rated voltage: 440VAC 50/60Hz
- Capacitance range: 0.0047 – 2.2 µF
- Lead spacing: 10.0 – 37.5 mm
- Capacitance tolerance: ±20%, ±10%
- Climatic category 40/110/56, IEC 60068-1
- Tape & Reel in accordance with IEC 60286-2
- RoHS compliant and lead-free terminations
- Operating temperature range of -40°C to +110°C
- 100% screening factory test at 2,200 VDC/1,500 VAC
- Self healing properties
- Automotive (AEC-Q200) grades available up to 22.5 mm lead spacing

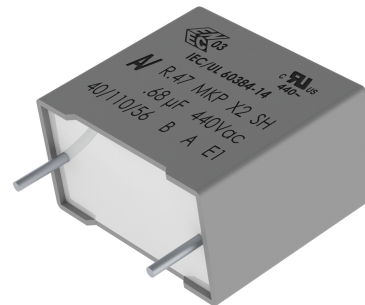

Part Number System

R47	4	F	1470	00	01	M
Series	Rated Voltage (VAC)	Lead Spacing (mm)	Capacitance Code (pF)	Packaging	Internal Use	Capacitance Tolerance
X2, Metallized Polypropylene	4 = 440	F = 10.0 I = 15.0 N = 22.5 R = 27.5 W = 37.5	The last three digits represent significant figures. The first digit specifies number of zeros to be added.	See Ordering Options Table	01 02 03	K = ±10% M = ±20%

Ordering Options Table

Lead Spacing Nominal (mm)	Type of Leads and Packaging	Lead Length (mm)	Lead and Packaging Code
10 15 22.5	Standard Lead and Packaging Options		
	Bulk (Bag) – Short Leads	4 +2/-0	00
	Ammo Pack	H ₀ = 18.5 ±0.5	DQ
	Other Lead and Packaging Options		
	Tape & Reel (Large Reel)	H ₀ = 18.5 ±0.5	CK
	Bulk (Bag) – Short Leads	3.5 +0.5/-0	JB
	Bulk (Bag) – Short Leads	4.0 +0.5/-0	JE
	Bulk (Bag) – Long Leads	30 +5/-0	40
Bulk (Bag) – Long Leads	25+2/-1	50	
27.5 37.5	Standard Lead and Packaging Options		
	Bulk (Tray) – Short Leads	4 +2/-0	00
	Tape & Reel (Large Reel)	H ₀ = 18.5 ±0.5	CK
	Other Lead and Packaging Options		
	Bulk (Tray) – Short Leads	3.5 +0.5/-0	JB
	Bulk (Tray) – Long Leads	30 +5/-0	40
	Bulk (Tray) – Long Leads	25 +2/-1	50

Dimensions – Millimeters

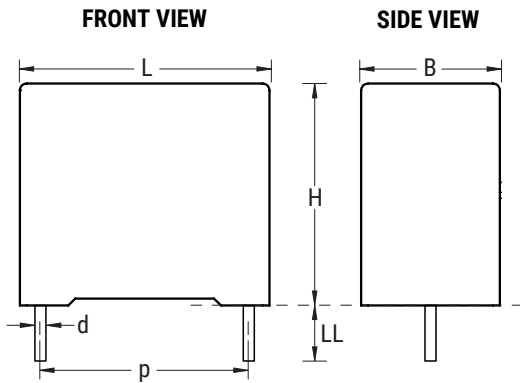

p		B		H		L		d	
Nominal	Tolerance	Nominal	Tolerance	Nominal	Tolerance	Nominal	Tolerance	Nominal	Tolerance
10.0	±0.4	4.0	+0.2	9.0	+0.1	13.0	+0.2	0.6	±0.05
10.0	±0.4	5.0	+0.2	11.0	+0.1	13.0	+0.2	0.6	±0.05
10.0	±0.4	6.0	+0.2	12.0	+0.1	13.0	+0.2	0.6	±0.05
15.0	±0.4	5.0	+0.2	11.0	+0.1	18.0	+0.3	0.6	±0.05
15.0	±0.4	6.0	+0.2	12.0	+0.1	18.0	+0.3	0.6	±0.05
15.0	±0.4	6.0	+0.2	17.5	+0.1	18.0	+0.3	0.6	±0.05
15.0	±0.4	7.5	+0.2	13.5	+0.1	18.0	+0.5	0.6	±0.05
15.0	±0.4	7.5	+0.2	18.5	+0.1	18.0	+0.5	0.8	±0.05
15.0	±0.4	8.5	+0.2	14.5	+0.1	18.0	+0.5	0.6	±0.05
15.0	±0.4	9.0	+0.2	12.5	+0.1	18.0	+0.5	0.6	±0.05
15.0	±0.4	10.0	+0.2	16.0	+0.1	18.0	+0.5	0.8	±0.05
15.0	±0.4	11.0	+0.2	19.0	+0.1	18.0	+0.5	0.8	±0.05
15.0	±0.4	13.0	+0.2	12.0	+0.1	18.0	+0.5	0.8	±0.05
22.5	±0.4	6.0	+0.2	15.0	+0.1	26.5	+0.3	0.8	±0.05
22.5	±0.4	6.5	+0.2	13.5	+0.1	26.5	+0.3	0.8	±0.05
22.5	±0.4	7.0	+0.2	16.0	+0.1	26.5	+0.3	0.8	±0.05
22.5	±0.4	8.5	+0.2	17.0	+0.1	26.5	+0.3	0.8	±0.05
22.5	±0.4	10.0	+0.2	18.5	+0.1	26.5	+0.3	0.8	±0.05
22.5	±0.4	11.0	+0.2	20.0	+0.1	26.5	+0.3	0.8	±0.05
22.5	±0.4	13.0	+0.2	22.0	+0.1	26.5	+0.3	0.8	±0.05
27.5	±0.4	9.0	+0.2	17.0	+0.1	32.0	+0.3	0.8	±0.05
27.5	±0.4	11.0	+0.2	20.0	+0.1	32.0	+0.3	0.8	±0.05
27.5	±0.4	13.0	+0.2	22.0	+0.1	32.0	+0.3	0.8	±0.05
27.5	±0.4	14.0	+0.2	28.0	+0.1	32.0	+0.3	0.8	±0.05
27.5	±0.4	18.0	+0.2	33.0	+0.1	32.0	+0.3	0.8	±0.05
27.5	±0.4	22.0	+0.2	37.0	+0.1	32.0	+0.3	0.8	±0.05
37.5	±0.4	11.0	+0.3	22.0	+0.1	41.5	+0.3	1.0	±0.05
37.5	±0.4	13.0	+0.3	24.0	+0.1	41.5	+0.3	1.0	±0.05
37.5	±0.4	16.0	+0.3	28.5	+0.1	41.5	+0.3	1.0	±0.05
37.5	±0.4	19.0	+0.3	32.0	+0.1	41.5	+0.3	1.0	±0.05
37.5	±0.4	20.0	+0.3	40.0	+0.1	41.5	+0.3	1.0	±0.05

Note: See Ordering Options Table for lead length (LL/H₀) options.

Performance Characteristics

Dielectric	Polypropylene film
Plates	Metal layer deposited by evaporation under vacuum
Winding	Non-inductive type
Leads	Tinned wire
Protection	Plastic case, thermosetting resin filled. Box material is solvent resistant and flame retardant according to UL94.
Related Documents	IEC 60384-14, EN 60384-14
Rated Voltage V_R	440 VAC (50/60 Hz), 1,000 VDC
Capacitance Range	4700 pF to 1 μ F
Capacitance Values	E6 series (IEC 60063) measured @ 1 kHz and +20 \pm 1°C
Capacitance Tolerance	\pm 10%, \pm 20%
Temperature Range	-40°C to +110°C
Climatic Category	40/110/56 IEC 60068-1
Storage Conditions	Storage time: \leq 24 months from the date marked on the label package
	Average relative humidity per year \leq 70%
	RH \leq 85% for 30 days randomly distributed throughout the year
	Dew is absent
	Temperature: -40 to 80°C (see "Maximum Humidity in Storage Conditions" graph below)
Approvals	ENEC, UL, cUL

Maximum Humidity in Storage Conditions

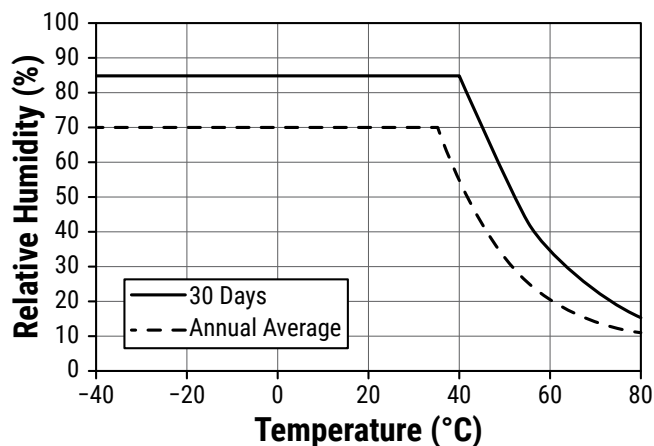

Performance Characteristics cont'd

Dissipation Factor ($\tan\delta$)	$\leq 0.1\%$ (0.06%*) at 1 kHz, +25°C $\pm 5^\circ\text{C}$ (* typical value)			
Test Voltage Between Terminals	The 100% screening factory test is carried out at 2,700 VDC/1,700 VAC. The voltage level is selected to meet the requirements in applicable equipment standards. All electrical characteristics are checked after the test. This test cannot be repeated, as there is a risk of damaging the capacitor. KEMET is not liable in such cases for any failures.			
Insulation Resistance	Measured at +25°C $\pm 5^\circ\text{C}$, according to IEC 60384-2			
	Minimum Values Between Terminals			
	Voltage Charge	Voltage Charge Time	$C \leq 0.33 \mu\text{F}$	$C > 0.33 \mu\text{F}$
	100 VDC	1 minute	$\geq 1 \cdot 10^5 \text{ M}\Omega$	$\geq 30,000 \text{ M}\Omega \cdot \mu\text{F}$
In DC Applications	Recommended voltage $\leq 1,000$ VDC			

Qualification

Automotive Grade products meet or exceed the requirements outlined by the Automotive Electronics Council. Details regarding test methods and conditions are referenced in document AEC-Q200, Stress Test Qualification for Passive Components. For additional information regarding the Automotive Electronics Council and AEC-Q200, please visit the website at www.aecouncil.com.

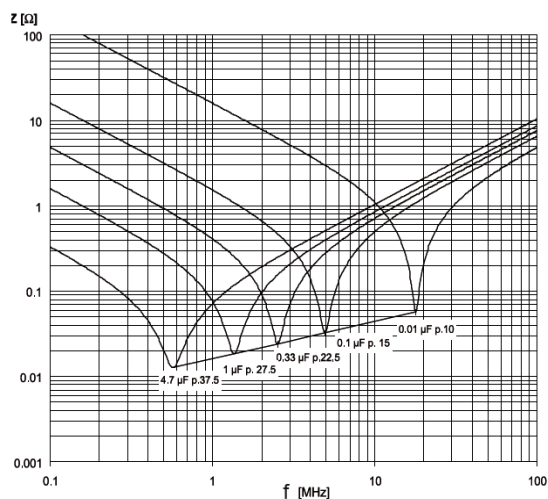

Impedance Graph



Environmental Test Data

Test	IEC Publication	Procedure
Endurance	EN/IEC 60384-14	1.25 x V _R VAC 50 Hz, once every hour increase to 1,000 VAC for 0.1 second, 1,000 hours at upper rated temperature
Vibration	IEC 60068-2-6 Test Fc	3 directions at 2 hours each 10 – 55 Hz at 0.75 mm or 98 m/s ²
Bump	IEC 60068-2-29 Test Eb	1,000 bumps at 390 m/s ²
Change of Temperature	IEC 60068-2-14 Test Na	Upper and lower rated temperature 5 cycles
Active Flammability	IEC 60384-14	V _R + 20 surge pulses at 2.5 kV (pulse every 5 seconds)
Passive Flammability	IEC 60384-14	IEC 60384-1, IEC 60695-11-5 Needle flame test
Damp Heat Steady State	IEC 60068-2-78 Test Cab	+40°C and 93% RH, 56 days

Approvals

Mark	Specification	File Number
	EN/IEC 60384-14	CA08.00101
	UL 60384-14 and CAN/CSA E60384-14 (440VAC)	E97797

Environmental Compliance

All KEMET EMI capacitors are RoHS compliant.

Table 1 – Ratings & Part Number Reference

Capacitance Value (µF)	Dimensions in mm			Lead Spacing (p)	dV/dt (V/µs)	New KEMET Part Number	Legacy Part Number
	B	H	L				
0.0047	4.0	9.0	13.0	10.0	750	474F1470(1)01(2)	R474F1470(1)01(2)
0.0068	5.0	11.0	13.0	10.0	750	474F1680(1)01(2)	R474F1680(1)01(2)
0.0082	6.0	12.0	13.0	10.0	750	474F1820(1)01(2)	R474F1820(1)01(2)
0.010	6.0	12.0	13.0	10.0	750	474F2100(1)01(2)	R474F2100(1)01(2)
0.010	5.0	11.0	18.0	15.0	600	474I2100(1)01(2)	R474I2100(1)01(2)
0.012	5.0	11.0	18.0	15.0	600	474I2120(1)01(2)	R474I2120(1)01(2)
0.015	5.0	11.0	18.0	15.0	600	474I2150(1)01(2)	R474I2150(1)01(2)
0.018	5.0	11.0	18.0	15.0	600	474I2180(1)01(2)	R474I2180(1)01(2)
0.022	6.0	12.0	18.0	15.0	600	474I2220(1)01(2)	R474I2220(1)01(2)
0.027	6.0	12.0	18.0	15.0	600	474I2270(1)01(2)	R474I2270(1)01(2)
0.033	6.0	12.0	18.0	15.0	600	474I2330(1)01(2)	R474I2330(1)01(2)
0.039	7.5	13.5	18.0	15.0	600	474I2390(1)01(2)	R474I2390(1)01(2)
0.047	7.5	13.5	18.0	15.0	600	474I2470(1)01(2)	R474I2470(1)01(2)
0.047	6.0	17.5	18.0	15.0	600	474I2470(1)02(2)	R474I2470(1)02(2)
0.047	9.0	12.5	18.0	15.0	600	474I2470(1)03(2)	R474I2470(1)03(2)
0.056	8.5	14.5	18.0	15.0	600	474I2560(1)01(2)	R474I2560(1)01(2)
0.068	10.0	16.0	18.0	15.0	600	474I2680(1)01(2)	R474I2680(1)01(2)
0.068	7.5	18.5	18.0	15.0	600	474I2680(1)02(2)	R474I2680(1)02(2)
0.068	13.0	12.0	18.0	15.0	600	474I2680(1)03(2)	R474I2680(1)03(2)
0.082	10.0	16.0	18.0	15.0	600	474I2820(1)01(2)	R474I2820(1)01(2)
0.10	11.0	19.0	18.0	15.0	600	474I3100(1)01(2)	R474I3100(1)01(2)
0.047	6.0	15.0	26.5	22.5	300	474N2470(1)01(2)	R474N2470(1)01(2)
0.047	6.5	13.5	26.5	22.5	300	474N2470(1)02(2)	R474N2470(1)02(2)
0.068	6.0	15.0	26.5	22.5	300	474N2680(1)01(2)	R474N2680(1)01(2)
0.10	7.0	16.0	26.5	22.5	300	474N3100(1)01(2)	R474N3100(1)01(2)
0.12	8.5	17.0	26.5	22.5	300	474N3120(1)01(2)	R474N3120(1)01(2)
0.15	10.0	18.5	26.5	22.5	300	474N3150(1)01(2)	R474N3150(1)01(2)
0.18	10.0	18.5	26.5	22.5	300	474N3180(1)01(2)	R474N3180(1)01(2)
0.22	11.0	20.0	26.5	22.5	300	474N3220(1)01(2)	R474N3220(1)01(2)
0.27	13.0	22.0	26.5	22.5	300	474N3270(1)01(2)	R474N3270(1)01(2)
0.33	13.0	22.0	26.5	22.5	300	474N3330(1)01(2)	R474N3330(1)01(2)
0.15	9.0	17.0	32.0	27.5	225	474R3150(1)01(2)	R474R3150(1)01(2)
0.18	9.0	17.0	32.0	27.5	225	474R3180(1)01(2)	R474R3180(1)01(2)
0.22	9.0	17.0	32.0	27.5	225	474R3220(1)01(2)	R474R3220(1)01(2)
0.27	9.0	17.0	32.0	27.5	225	474R3270(1)02(2)	R474R3270(1)02(2)
0.33	11.0	20.0	32.0	27.5	225	474R3330(1)02(2)	R474R3330(1)02(2)
0.39	11.0	20.0	32.0	27.5	225	474R3390(1)01(2)	R474R3390(1)01(2)
0.47	13.0	22.0	32.0	27.5	225	474R3470(1)01(2)	R474R3470(1)01(2)
0.56	13.0	22.0	32.0	27.5	225	474R3560(1)01(2)	R474R3560(1)01(2)
0.68	14.0	28.0	32.0	27.5	225	474R3680(1)01(2)	R474R3680(1)01(2)
0.82	18.0	33.0	32.0	27.5	225	474R3820(1)01(2)	R474R3820(1)01(2)
1.0	18.0	33.0	32.0	27.5	225	474R4100(1)01(2)	R474R4100(1)01(2)
1.2	18.0	33.0	32.0	27.5	225	474R4120(1)01(2)	R474R4120(1)01(2)
1.5	22.0	37.0	32.0	27.5	225	474R4150(1)01(2)	R474R4150(1)01(2)
0.47	11.0	22.0	41.5	37.5	150	474W3470(1)01(2)	R474W3470(1)01(2)
0.56	11.0	22.0	41.5	37.5	150	474W3560(1)01(2)	R474W3560(1)01(2)
0.68	13.0	24.0	41.5	37.5	150	474W3680(1)01(2)	R474W3680(1)01(2)
0.82	16.0	28.5	41.5	37.5	150	474W3820(1)01(2)	R474W3820(1)01(2)
1.0	16.0	28.5	41.5	37.5	150	474W4100(1)01(2)	R474W4100(1)01(2)
1.2	19.0	32.0	41.5	37.5	150	474W4120(1)01(2)	R474W4120(1)01(2)
1.5	19.0	32.0	41.5	37.5	150	474W4150(1)01(2)	R474W4150(1)01(2)
1.8	20.0	40.0	41.5	37.5	150	474W4180(1)01(2)	R474W4180(1)01(2)
2.2	20.0	40.0	41.5	37.5	150	474W4220(1)01(2)	R474W4220(1)01(2)
Capacitance Value (µF)	B (mm)	H (mm)	L (mm)	Lead Spacing (p)	dV/dt (V/µs)	New KEMET Part Number	Legacy Part Number

(1) Insert ordering code for lead type and packaging. See Ordering Options Table for available options.

(2) M = ±20%, K = ±10%

Soldering Process

The implementation of the RoHS directive has resulted in the selection of SnAuCu (SAC) alloys or SnCu alloys as primary solder material. This has increased the liquidus temperature from 183°C for SnPb eutectic alloys to 217 – 221°C for the new alloys. As a result, the heat stress to the components, even in wave soldering, has increased considerably due to higher pre-heat and wave temperatures. Polypropylene capacitors are especially sensitive to heat (the melting point of polypropylene is 160 – 170°C). Wave soldering can be destructive, especially for mechanically small polypropylene capacitors (with lead spacing of 5 – 15 mm). Great care must be taken during soldering. The recommended solder profiles from KEMET should be used. Consult KEMET with any questions. In general, the wave soldering curve from IEC Publication 61760-1 Edition 2 serves as a solid guideline for successful soldering. See Figure 1.

Reflow soldering is not recommended for through-hole film capacitors. Exposing capacitors to a soldering profile in excess of the above-recommended limits may result to degradation of or permanent damage to the capacitors.

Do not place the polypropylene capacitor through an adhesive curing oven to cure resin for surface mount components. Insert through-hole parts after curing surface mount parts. Consult KEMET to discuss the actual temperature profile in the oven, if through-hole components must pass through the adhesive curing process. A maximum two soldering cycles is recommended. Allow time for the capacitor surface temperature to return to normal temperature before performing the second soldering cycle.

Manual Soldering Recommendations

Following is the recommendation for manual soldering with a soldering iron.

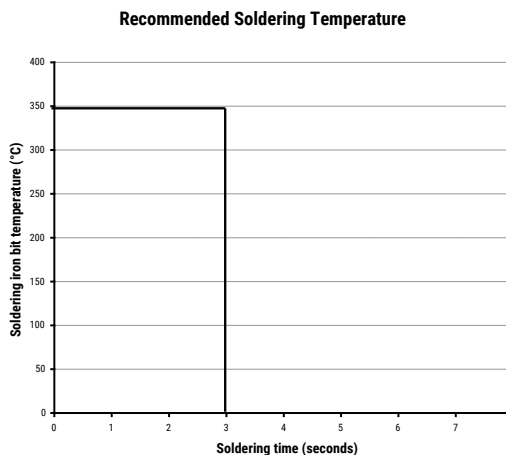

The soldering iron tip temperature should be set at 350°C (+10°C maximum), with the soldering duration not to exceed more than 3 seconds.

Wave Soldering Recommendations

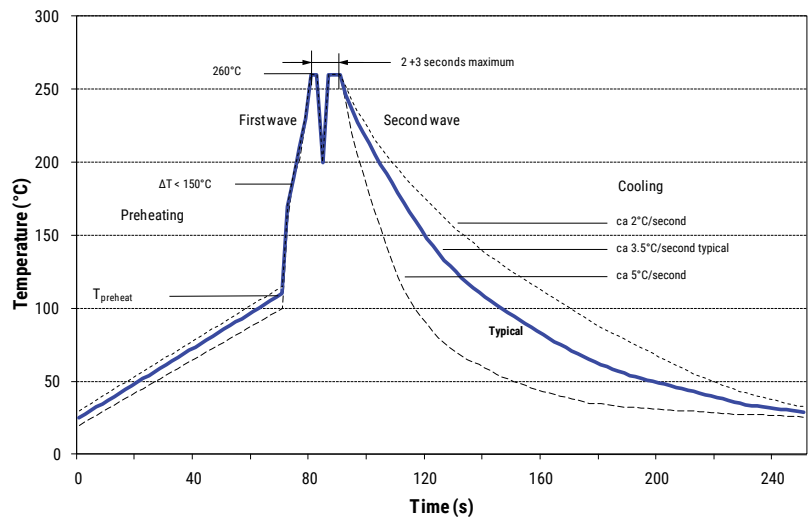

Soldering Process cont'd

Wave Soldering Recommendations cont'd

1. The table indicates the maximum set-up temperature of the soldering process.

Dielectric Film Material	Maximum Preheat Temperature			Maximum Peak Soldering Temperature	
	Capacitor Pitch ≤ 10 mm	Capacitor Pitch = 15 mm	Capacitor Pitch > 15 mm	Capacitor Pitch ≤ 15 mm	Capacitor Pitch > 15 mm
Polyester	130°C	130°C	130°C	270°C	270°C
Polypropylene	100°C	110°C	130°C	260°C	270°C
Paper	130°C	130°C	140°C	270°C	270°C
Polyphenylene Sulphide	150°C	150°C	160°C	270°C	270°C

2. The maximum temperature measured inside the capacitor: set the temperature so that the maximum temperature inside the element is below the limit.

Dielectric Film Material	Maximum Temperature Measured Inside the Element
Polyester	160°C
Polypropylene	110°C
Paper	160°C
Polyphenylene Sulphide	160°C

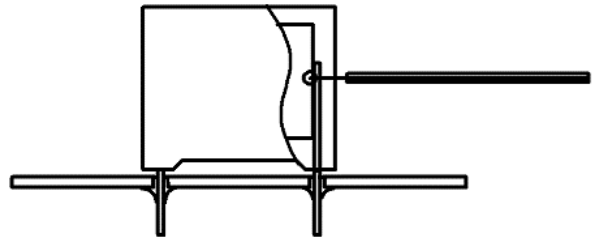

Temperature monitored inside the capacitor.

Selective Soldering Recommendations

Selective dip soldering is a variation of reflow soldering. In this method, the printed circuit board with through-hole components to be soldered is preheated and transported over the solder bath as it is in normal flow soldering, without touching the solder. When the board is over the bath, it is stopped. Pre-designed solder pots are lifted from the bath with molten solder, only at the places of the selected components, and pressed against the lower surface of the board to solder the components.

The temperature profile for selective soldering is similar to the double wave flow soldering outlined in this document.

However, instead of two baths, there is only one with a time from 3 – 10 seconds. In selective soldering, the risk of overheating is greater than in double wave flow soldering, and great care must be taken so that the parts do not overheat.

Construction

2 Sections

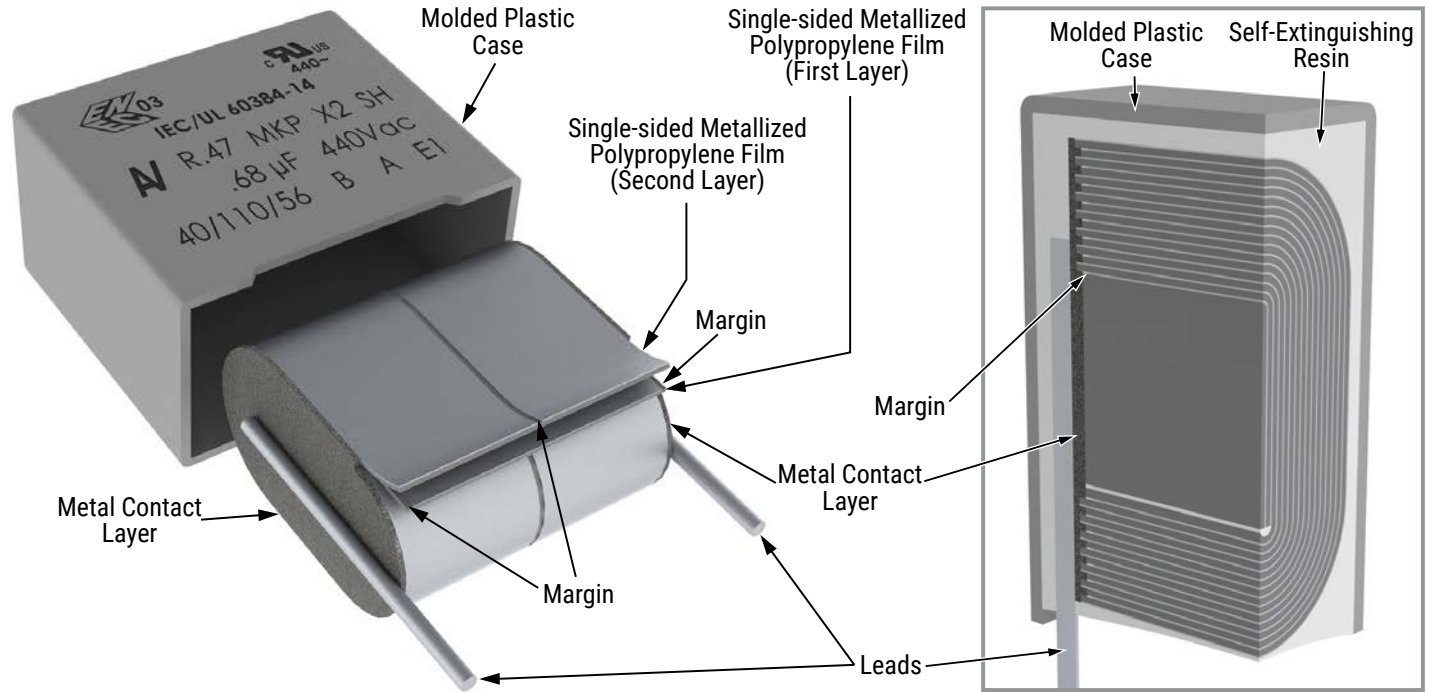

Winding Scheme

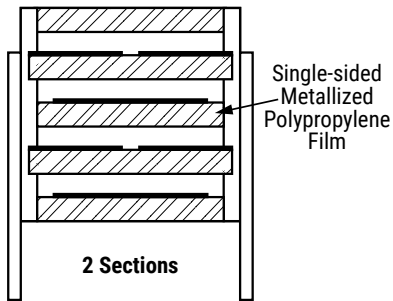

Marking

Lead Spacing 10 mm

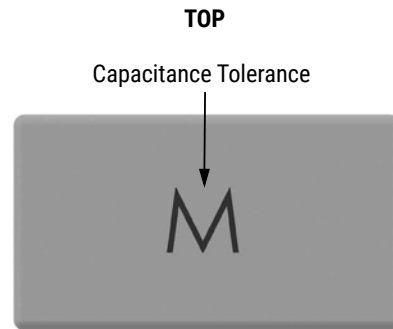
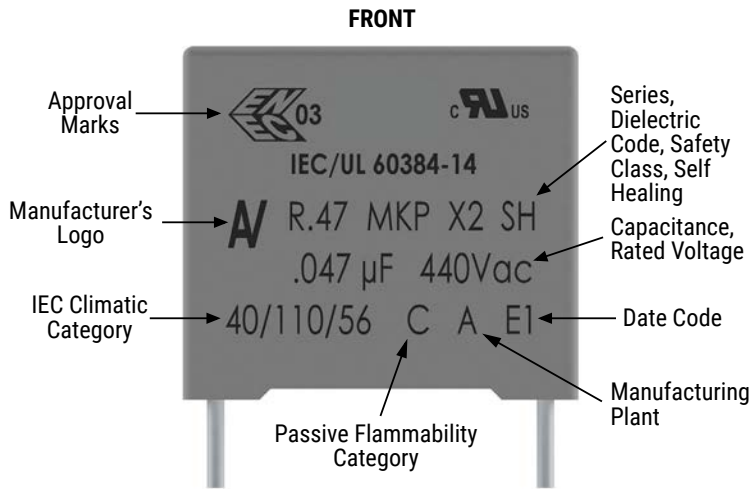

Lead Spacing 15 mm, 22.5 mm (small case sizes)

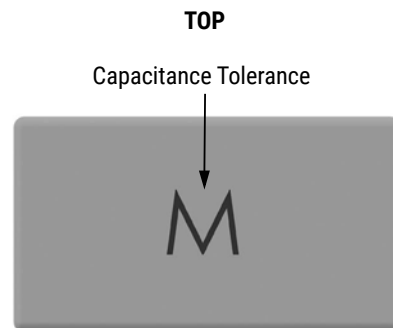
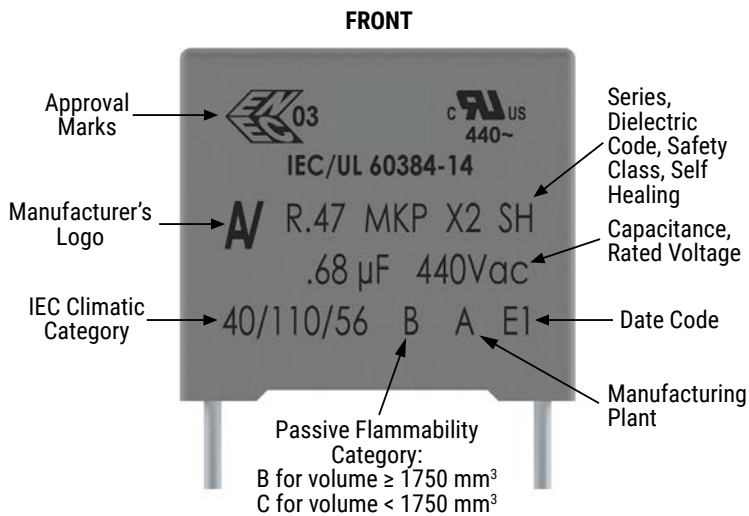

Marking cont'd

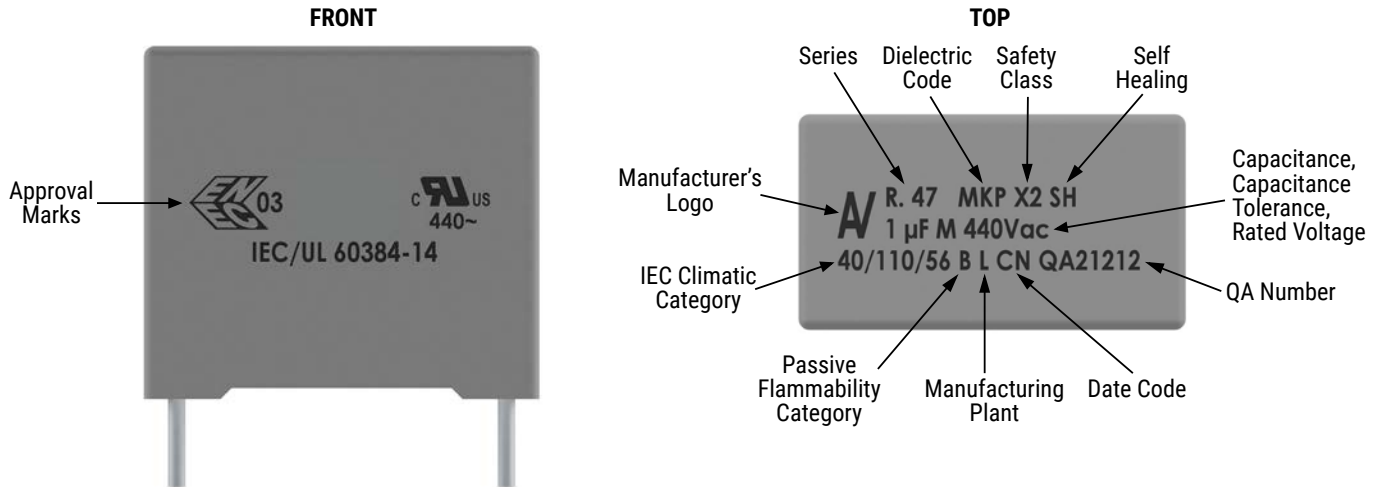

Manufacturing Date Code (IEC-60062)			
Y = Year, Z = Month			
Year	Code	Month	Code
2000	M	January	1
2001	N	February	2
2002	P	March	3
2003	R	April	4
2004	S	May	5
2005	T	June	6
2006	U	July	7
2007	V	August	8
2008	W	September	9
2009	X	October	0
2010	A	November	N
2011	B	December	D
2012	C		
2013	D		
2014	E		
2015	F		
2016	H		
2017	J		
2018	K		
2019	L		
2020	M		

Packaging Quantities

Lead Spacing (mm)	Thickness (mm)	Height (mm)	Length (mm)	Bulk Short Leads	Bulk Long Leads	Standard Reel ø 355 mm	Large Reel ø 500 mm	Ammo Taped
10	4	9	13	2000	1800	750	1500	1000
	5	11	13	1300	1500	600	1250	800
	6	12	13	1000	1200	500	1000	680
15	5	11	18	2000	1000	600	1250	800
	6	12	18	1750	900	500	1000	680
	6	17.5	18	1000	700	500	1000	680
	7.5	13.5	18	1000	700	350	800	500
	7.5	18.5	18	900	500	-	800	500
	8.5	14.5	18	1000	500	300	700	440
	9	12.5	18	1000	520	270	650	410
	10	16	18	750	500	300	600	380
	11	19	18	450	350	-	500	340
13	12	18	750	490	200	480	280	
22.5	6	15	26.5	805	500	-	700	464
	6.5	13.5	26.5	800	-	-	-	-
	7	16	26.5	700	500	-	550	380
	8.5	17	26.5	468	300	-	450	280
	10	18.5	26.5	396	300	-	350	235
	11	20	26.5	360	250	-	350	217
	13	22	26.5	300	200	-	300	-
27.5	9	17	32	816	408	-	450	-
	11	20	32	560	336	-	350	-
	13	22	32	480	288	-	300	-
	14	28	32	352	176	-	-	-
	18	33	32	256	128	-	-	-
	22	37	32	168	112	-	-	-
37.5	11	22	41.5	420	252	-	-	-
	13	24	41.5	360	216	-	-	-
	16	28.5	41.5	216	108	-	-	-
	19	32	41.5	192	96	-	-	-
	20	40	41.5	126	84	-	-	-

Lead Taping & Packaging (IEC 60286-2)

Figure 1
Lead Spacing 10 mm



Figure 2
Lead Spacing 15 mm



Figure 3
Lead Spacing 22.5 – 27.5 mm

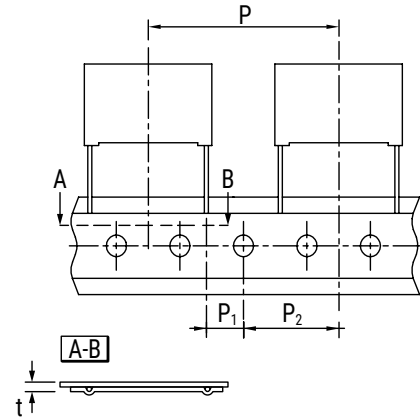

Taping Specification

Description	Symbol	Dimensions (mm)					Tol.
		Lead Space					
		10 Fig. 1	15 Fig. 2	22.5 Fig. 3	27.5 Fig. 3		
Lead wire diameter	d	0.6	0.6-0.8	0.8	0.8	±0.05	
Taping lead space	P	25.4	25.4	38.1	38.1	±1	
Feed hole lead space *	P ₀	12.7	12.7	12.7	12.7	±0.2 **	
Centering of the lead wire	P ₁	7.7	5.2	7.8	5.3	±0.7	
Centering of the body	P ₂	12.7	12.7	19.05	19.05	±1.3	
Lead spacing (pitch) ***	F	10	15	22.5	27.5	+0.6/-0.1	
Component alignment	Δh	0	0	0	0	±2	
Height of component from tape center	H ₀ ****	18.5	18.5	18.5	18.5	±0.5	
Carrier tape width	W	18	18	18	18	+1/-0.5	
Hold down tape width	W ₀	9	10	10	10	Minimum	
Hole position	W ₁	9	9	9	9	±0.5	
Hold down tape position	W ₂	3	3	3	3	Maximum	
Feed hole diameter	D ₀	4	4	4	4	±0.2	
Total tape thickness	t	0.7	0.7	0.7	0.7	±0.2	

* 15 mm also available

** Maximum of 1 mm on 20 lead spaces

*** Pitches 15 mm and 10 mm taped to 7.5 mm (crimped leads) available upon request

**** H₀ = 16.5 mm is available upon request

Lead Taping & Packaging (IEC 60286-2) cont'd

Ammo Specifications

Dimensions (mm)		
H	W	T
360	340	59



Reel Specifications

Reel Size	Dimensions (mm)		
	D	H	W
Standard	355	30	55 Maximum
Large	500	25	



KEMET Electronics Corporation Sales Offices

For a complete list of our global sales offices, please visit www.kemet.com/sales.

Disclaimer

All product specifications, statements, information and data (collectively, the "Information") in this datasheet are subject to change. The customer is responsible for checking and verifying the extent to which the Information contained in this publication is applicable to an order at the time the order is placed. All Information given herein is believed to be accurate and reliable, but it is presented without guarantee, warranty, or responsibility of any kind, expressed or implied.

Statements of suitability for certain applications are based on KEMET Electronics Corporation's ("KEMET") knowledge of typical operating conditions for such applications, but are not intended to constitute – and KEMET specifically disclaims – any warranty concerning suitability for a specific customer application or use. The Information is intended for use only by customers who have the requisite experience and capability to determine the correct products for their application. Any technical advice inferred from this Information or otherwise provided by KEMET with reference to the use of KEMET's products is given gratis, and KEMET assumes no obligation or liability for the advice given or results obtained.

Although KEMET designs and manufactures its products to the most stringent quality and safety standards, given the current state of the art, isolated component failures may still occur. Accordingly, customer applications which require a high degree of reliability or safety should employ suitable designs or other safeguards (such as installation of protective circuitry or redundancies) in order to ensure that the failure of an electrical component does not result in a risk of personal injury or property damage.

Although all product-related warnings, cautions and notes must be observed, the customer should not assume that all safety measures are indicated or that other measures may not be required.

KEMET is a registered trademark of KEMET Electronics Corporation.

单击下面可查看定价，库存，交付和生命周期等信息

[>>KEMET\(基美\)](#)