

# R71, Single Metallized Polypropylene Film, Radial, SMPS PFC Applications

## Overview

The R71 is constructed of metallized polypropylene film with radial leads of tinned wire. The radial leads are electrically welded to the metal layer on the ends of the capacitor winding. The capacitor is encapsulated in a self-extinguishing solvent resistant plastic case with thermosetting resin material meeting UL 94 V-0 requirements.

## Applications

Typical applications include power factor correction and pulse applications. Not suitable for across-the-line application (see Suppressor Capacitors).

## Benefits

- Voltage range: 420 – 1,000 VDC
- Capacitance range: 0.01 – 22  $\mu$ F
- Lead Spacing: 10 – 37.5 mm
- Capacitance tolerance:  $\pm$ 10%,  $\pm$ 20%,  $\pm$ 5% (on request)
- Climatic category: 55/105/56 IEC 60068-1
- Operating temperature range of  $-55^{\circ}\text{C}$  to  $+105^{\circ}\text{C}$
- RoHS compliance and lead-free terminations
- Tape & Reel packaging in accordance with IEC 60286-2
- Self-healing

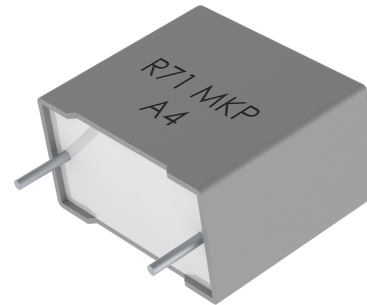

## Part Number System

R71	M	F	2100	AA	00	J
Series	Rated Voltage (VDC)	Lead Spacing (mm)	Capacitance Code (pF)	Packaging	Internal Use	Capacitance Tolerance
Metallized Polypropylene	M = 420 V = 520 P = 630 Q = 1,000	F = 10.0 I = 15.0 N = 22.5 R = 27.5 W = 37.5	The last three digits represent significant figures. The first digit specifies the total number of zeros to be added.	See Ordering Options Table	00 10 20 30 40	J = $\pm$ 5% K = $\pm$ 10% M = $\pm$ 20%

## Ordering Options Table

Lead Spacing Nominal (mm)	Type of Leads and Packaging	Lead Length (mm)	Lead and Packaging Code
10  15  22.5	<b>Standard Lead and Packaging Options</b>		
	Bulk (Bag) – Short Leads	4 +2/-0	AA
	Ammo Pack	H <sub>0</sub> = 18.5 ±0.5	DQ
	<b>Other Lead and Packaging Options</b>		
	Tape & Reel (Standard Reel Ø 355 mm)	H <sub>0</sub> =18.5 ±0.5	GY
	Tape & Reel (Large Reel Ø 500 mm)	H <sub>0</sub> =18.5 ±0.5	CK
	Bulk (Bag) – Short Leads	3.5 +0.5/-0	JB
	Bulk (Bag) – Short Leads	4.0 +0.5/-0	JE
	Bulk (Bag) – Short Leads	3.2 +0.3/-0.2	JH
	Bulk (Bag) – Long Leads	18 ±1	JM
Bulk (Bag) – Long Leads	30 +5/-0	40	
Bulk (Bag) – Long Leads	25 +2/-1	50	
27.5	<b>Standard Lead and Packaging Options</b>		
	Bulk (Tray) – Short Leads	4 +2/-0	AA
	<b>Other Lead and Packaging Options</b>		
	Tape & Reel (Standard Reel Ø 355 mm)	H <sub>0</sub> =18.5 ±0.5	GY
	Tape & Reel (Large Reel Ø 500 mm)	H <sub>0</sub> =18.5 ±0.5	CK
	Bulk (Tray) – Short Leads	3.5 +0.5/-0	JB
	Bulk (Tray) – Short Leads	4.0 +0.5/-0	JE
	Bulk (Tray) – Short Leads	3.2 +0.3/-0.2	JH
	Bulk (Tray) – Long Leads	18 ±1	JM
	Bulk (Tray) – Long Leads	30 +5/-0	40
Bulk (Tray) – Long Leads	25 +2/-1	50	
37.5	<b>Standard Lead and Packaging Options</b>		
	Bulk (Tray) – Short Leads	4 +2/-0	AA
	<b>Other Lead and Packaging Options</b>		
	Bulk (Tray) – Short Leads	3.5 +0.5/-0	JB
	Bulk (Tray) – Short Leads	4.0 +0.5/-0	JE
	Bulk (Tray) – Short Leads	3.2 +0.3/-0.2	JH
	Bulk (Tray) – Long Leads	18 ±1	JM
	Bulk (Tray) – Long Leads	30 +5/-0	40
Bulk (Tray) – Long Leads	25 +2/-1	50	

## Dimensions – Millimeters

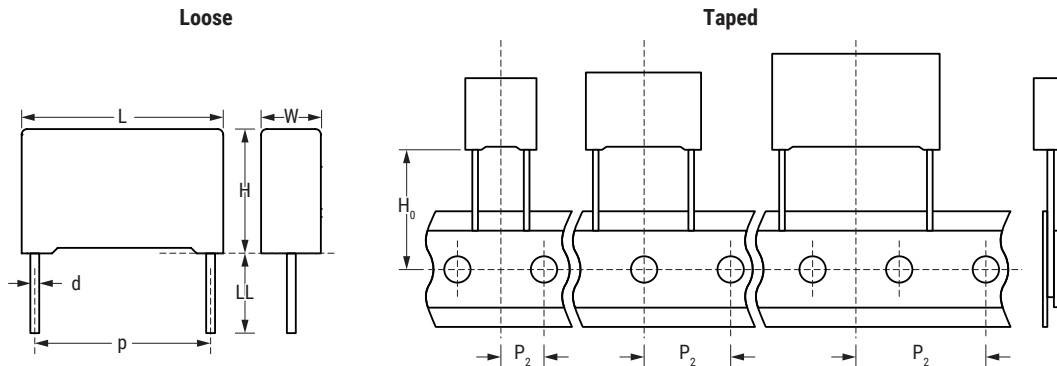

p		W		H		L		d	
Nominal	Tolerance	Nominal	Tolerance	Nominal	Tolerance	Nominal	Tolerance	Nominal	Tolerance
10.0	±0.4	4.0	+0.2	9.0	+0.1	13.0	+0.2	0.6	±0.05
10.0	±0.4	5.0	+0.2	11.0	+0.1	13.0	+0.2	0.6	±0.05
10.0	±0.4	6.0	+0.2	12.0	+0.1	13.0	+0.2	0.6	±0.05
15.0	±0.4	5.0	+0.2	11.0	+0.1	18.0	+0.3	0.6	±0.05
15.0	±0.4	6.0	+0.2	12.0	+0.1	18.0	+0.3	0.6	±0.05
15.0	±0.4	6.0	+0.2	17.5	+0.1	18.0	+0.3	0.6	±0.05
15.0	±0.4	7.5	+0.2	13.5	+0.1	18.0	+0.5	0.6	±0.05
15.0	±0.4	7.5	+0.2	18.5	+0.1	18.0	+0.5	0.8	±0.05
15.0	±0.4	8.5	+0.2	14.5	+0.1	18.0	+0.5	0.6	±0.05
15.0	±0.4	9.0	+0.2	12.5	+0.1	18.0	+0.5	0.6	±0.05
15.0	±0.4	10.0	+0.2	16.0	+0.1	18.0	+0.5	0.8	±0.05
15.0	±0.4	11.0	+0.2	19.0	+0.1	18.0	+0.5	0.8	±0.05
15.0	±0.4	13.0	+0.2	12.0	+0.1	18.0	+0.5	0.8	±0.05
22.5	±0.4	6.0	+0.2	15.0	+0.1	26.5	+0.3	0.8	±0.05
22.5	±0.4	7.0	+0.2	16.0	+0.1	26.5	+0.3	0.8	±0.05
22.5	±0.4	8.5	+0.2	17.0	+0.1	26.5	+0.3	0.8	±0.05
22.5	±0.4	10.0	+0.2	18.5	+0.1	26.5	+0.3	0.8	±0.05
22.5	±0.4	11.0	+0.2	20.0	+0.1	26.5	+0.3	0.8	±0.05
22.5	±0.4	13.0	+0.2	22.0	+0.1	26.5	+0.3	0.8	±0.05
27.5	±0.4	9.0	+0.2	17.0	+0.1	32.0	+0.3	0.8	±0.05
27.5	±0.4	11.0	+0.2	20.0	+0.1	32.0	+0.3	0.8	±0.05
27.5	±0.4	13.0	+0.2	22.0	+0.1	32.0	+0.3	0.8	±0.05
27.5	±0.4	13.0	+0.2	25.0	+0.1	32.0	+0.3	0.8	±0.05
27.5	±0.4	14.0	+0.2	28.0	+0.1	32.0	+0.3	0.8	±0.05
27.5	±0.4	18.0	+0.2	33.0	+0.1	32.0	+0.3	0.8	±0.05
27.5	±0.4	22.0	+0.2	37.0	+0.1	32.0	+0.3	0.8	±0.05
37.5	±0.4	11.0	+0.3	22.0	+0.1	41.5	+0.3	1.0	±0.05
37.5	±0.4	13.0	+0.3	24.0	+0.1	41.5	+0.3	1.0	±0.05
37.5	±0.4	16.0	+0.3	28.5	+0.1	41.5	+0.3	1.0	±0.05
37.5	±0.4	19.0	+0.3	32.0	+0.1	41.5	+0.3	1.0	±0.05
37.5	±0.4	20.0	+0.3	40.0	+0.1	41.5	+0.3	1.0	±0.05
37.5	±0.4	24.0	+0.3	44.0	+0.1	41.5	+0.3	1.0	±0.05
37.5	±0.4	30.0	+0.3	45.0	+0.1	41.5	+0.3	1.0	±0.05

**Note: See Ordering Options Table for lead length (LL/Ho) options.**

## Performance Characteristics

Dielectric	Polypropylene film				
Plates	Metal layer deposited by evaporation under vacuum				
Winding	Non-inductive type				
Leads	Tinned wire				
Protection	Plastic case, thermosetting resin filled. Box material is solvent resistant and flame retardant according to UL94.				
Rated Voltage $V_R$ (VDC)	420	520	630	1,000	
Rated Voltage $V_R$ (VAC)	220	250	275	275	
Capacitance Range ( $\mu\text{F}$ )	0.01 – 22	0.01 – 22	0.01 – 15	0.22 – 10	
Capacitance Values	E12 series (IEC 60063) measured at 1 kHz and +20 $\pm 1^\circ\text{C}$				
Capacitance Tolerance	$\pm 10\%$ , $\pm 20\%$ , $\pm 5\%$ on request				
Operating Temperature Range	$-40^\circ\text{C}$ to $+110^\circ\text{C}$				
Rated Temperature $T_R$	$+105^\circ\text{C}$				
Voltage Derating	Above $+105^\circ\text{C}$ DC and AC voltage derating is 4%/°C				

**Maximum Humidity in Storage Conditions**

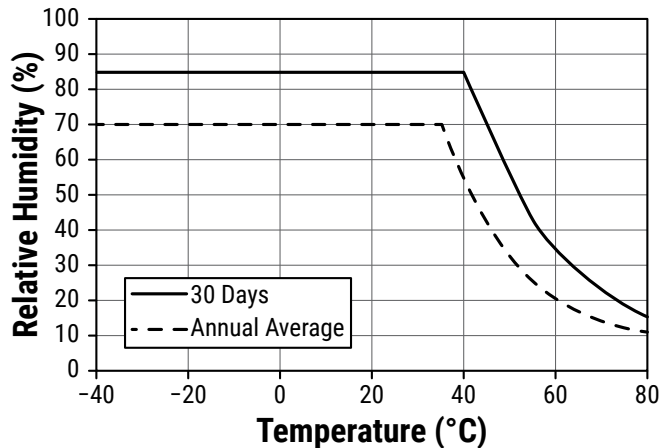

**Maximum Overtemperature  $\Delta T_{lim}$  vs.  $T_h$**

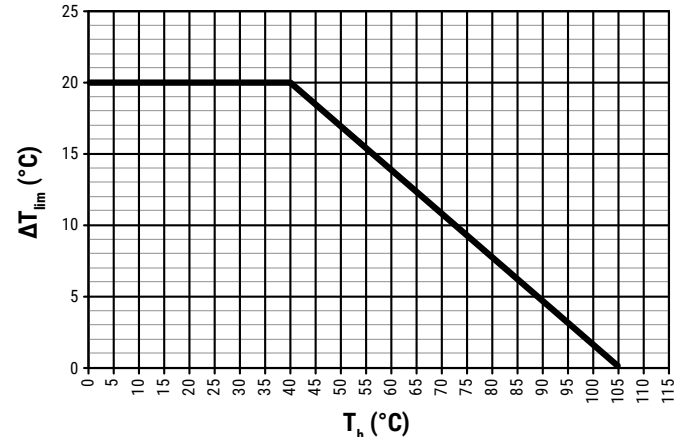

$T_h$  is the maximum ambient temperature surrounding the capacitor or hottest contact point (e.g. tracks), whichever is higher, in the worst operation conditions in °C.

## Performance Characteristics cont.

Climatic Category	40/110/56 IEC 60068-1					
Storage Conditions	Storage time: ≤ 24 months from the date marked on the package label					
	Average relative humidity per year ≤ 70%					
	RH ≤ 85% for 30 days randomly distributed throughout the year					
	Dew is absent					
	Temperature: -40 to 80°C (see "Maximum Humidity in Storage Conditions" graph below)					
Test Voltage	1.6 x V <sub>R</sub> VDC for 2 seconds (between terminations) at +25°C ±5°C					
Capacitance Drift	Maximum 0.5% after a 2 year storage period at a temperature of +10°C to +40°C and a relative humidity of 40% to 60%					
Maximum Pulse Steepness	dV/dt according to Table 1. For working voltages lower than rated voltage (V < V <sub>R</sub> ), the specified dV/dt can be multiplied by the factor V <sub>R</sub> /V.					
Temperature Coefficient	-(200 ±100) ppm/°C at 1 kHz					
Self Inductance (Lead Length ~ 2 mm)	Lead Spacing (mm)	10	15	22.5	27.5	37.5
	L (nH) ≈	9	10	16	18	20
	Maximum 1 nH per 1 mm lead and capacitor length.					
Dissipation Factor tanδ	≤ 0.1% (0.06%)* at 25°C ±5°C (* typical value)					
Insulation Resistance	Measured at +25°C ±5°C, 100 VDC 60 seconds					
	Minimum Values Between Terminals					
		C ≤ 0.33 μF		C > 0.33 μF		
		≥ 100,000 MΩ (≥ 500,000 MΩ)*		≥ 30,000 MΩ · μF (≥ 150,000 MΩ · μF)*		

\* Typical value

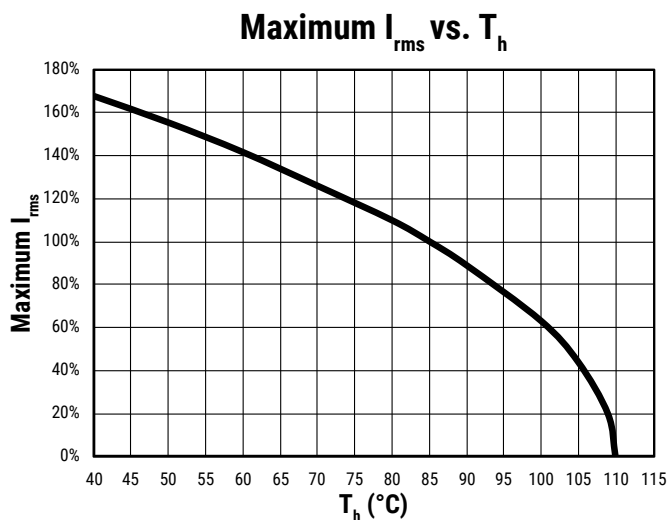

## Maximum Voltage ( $V_{rms}$ ) vs. Frequency (Sinusoidal Waveform/ $Th \leq 85^\circ C$ )

**420 VDC/220 VAC**

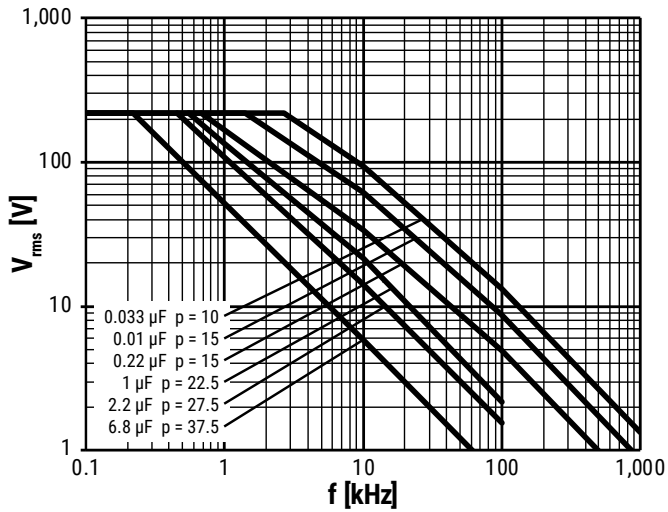

**520 VDC/250 VAC**

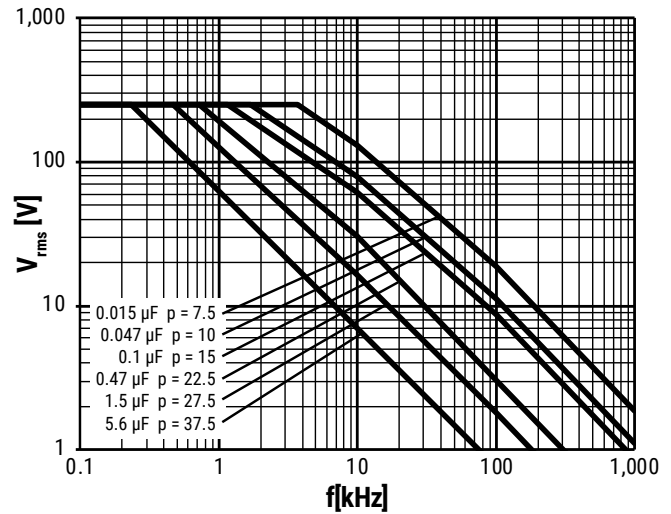

**630 VDC/275 VAC**

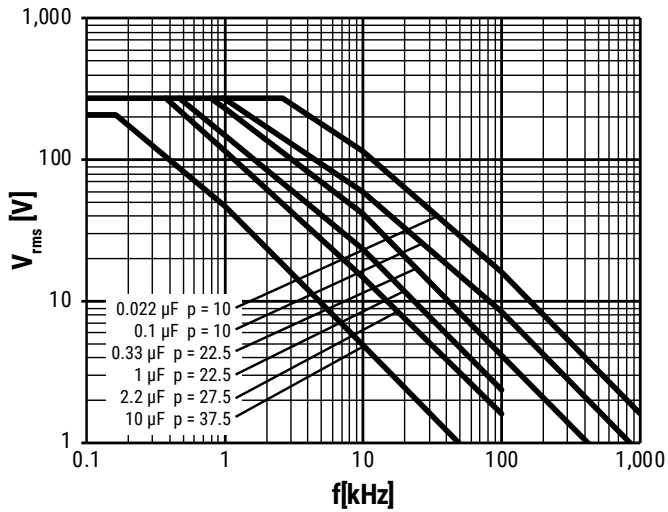

**1,000 VDC/275 VAC**

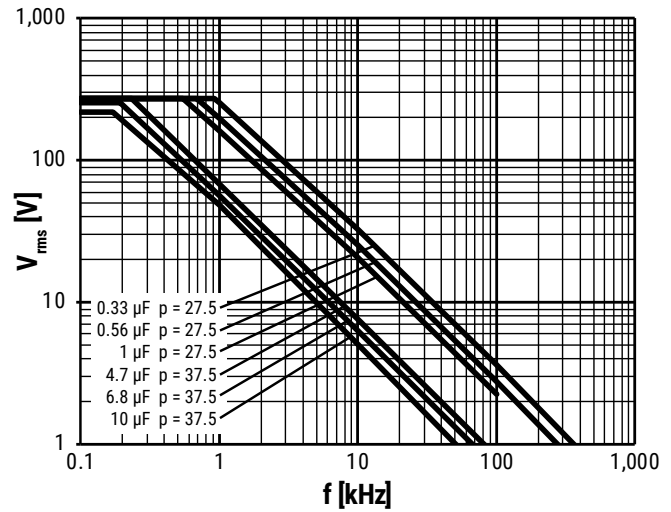

## Maximum Current ( $I_{rms}$ ) vs. Frequency (Sinusoidal Waveform/ $Th \leq 85^\circ C$ )

420 VDC/220 VAC

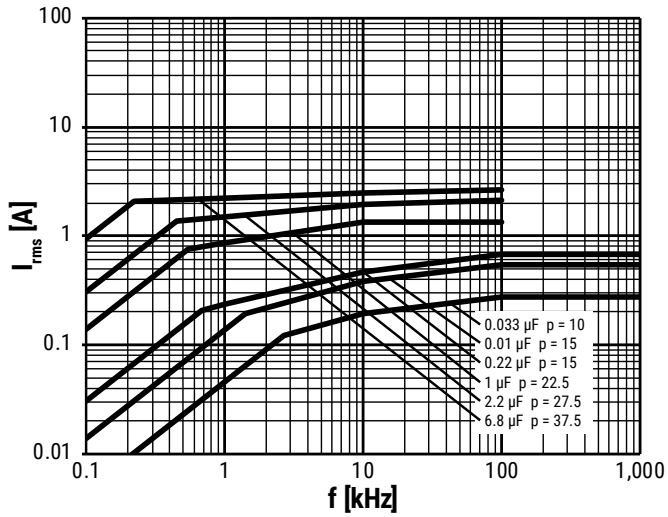

520 VDC/250 VAC

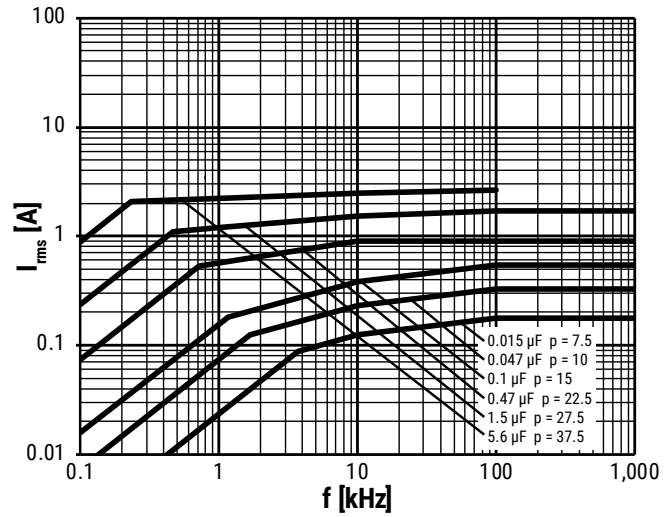

630 VDC/275 VAC

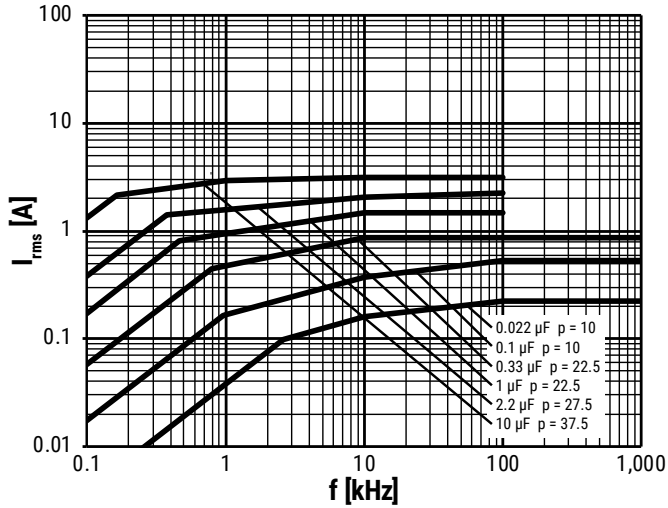

1,000 VDC/275 VAC

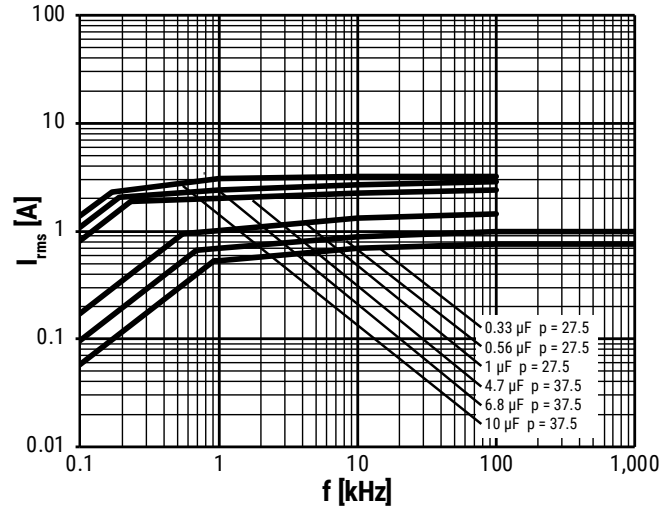

## Environmental Test Data

Damp Heat, Steady State Test	Test Conditions:		Performances
Test 1st	Temperature: Relative humidity (RH): Test duration:	+40°C ±2°C 93% ±2% 56 days	Δ C/C  ≤ 5%, IR after test ≥ 50% of initial limit
Test 2nd	Temperature: Relative humidity (RH): Test duration:	+60°C ±2°C 95% ±2% 500 hours	
Endurance Test	Test Conditions		Performances
	Temperature: Voltage applied: Test duration:	+105°C ±2°C 1.25 x V <sub>R</sub> (DC) 2,000 hours	Δ C/C  ≤ 5%, IR after test ≥ 50% of initial limit
Resistance to Soldering Heat Test	Test Conditions		Performances
	Solder bath temperature: Dipping time (with heat screen):	260°C ±5°C 10 seconds ±1 second	Δ C/C  ≤ 2%

## Environmental Compliance

All KEMET pulse capacitors are RoHS Compliant.



**Table 1 – Ratings & Part Number Reference**

VDC	VAC	Cap Value (µF)	Dimensions in mm			Lead Spacing (p)	Φd (mm)	dV/dt (V/µs)	Max K <sub>0</sub> (V <sup>2</sup> /µs)	I <sub>pk</sub>	ESL	ESR	I <sub>rms</sub> max (*)	R <sub>th</sub>	KEMET Internal Part Number	Customer Part Number
			Lead Length 2x 4 mm	at 100 kHz	at 100 kHz, 85°C						R <sub>th</sub>					
												A <sub>pk</sub>	nH			
W	H	L	A <sub>pk</sub>	nH	mΩ	A <sub>rms</sub>	(°C/W)									
420	220	0.010	4.0	9.0	13.0	10.0	0.6	250	210,000	2.5	9	3,979	0.17	61	71MF2100(1)00(2)	R71MF2100(1)00(2)
420	220	0.015	4.0	9.0	13.0	10.0	0.6	250	210,000	3.8	9	2,653	0.21	61	71MF2150(1)00(2)	R71MF2150(1)00(2)
420	220	0.022	4.0	9.0	13.0	10.0	0.6	250	210,000	5.5	9	1,809	0.25	61	71MF2220(1)00(2)	R71MF2220(1)00(2)
420	220	0.033	4.0	9.0	13.0	10.0	0.6	250	210,000	8.3	9	1,206	0.31	61	71MF2330(1)00(2)	R71MF2330(1)00(2)
420	220	0.047	4.0	9.0	13.0	10.0	0.6	250	210,000	11.8	9	847	0.37	61	71MF2470(1)00(2)	R71MF2470(1)00(2)
420	220	0.068	4.0	9.0	13.0	10.0	0.6	250	210,000	17.0	9	585	0.45	61	71MF2680(1)30(2)	R71MF2680(1)30(2)
420	220	0.10	4.0	9.0	13.0	10.0	0.6	250	210,000	25.0	9	398	0.54	61	71MF3100(1)30(2)	R71MF3100(1)30(2)
420	220	0.15	5.0	11.0	13.0	10.0	0.6	250	210,000	37.5	9	265	0.69	57	71MF3150(1)30(2)	R71MF3150(1)30(2)
420	220	0.22	6.0	12.0	13.0	10.0	0.6	250	210,000	55.0	9	181	0.85	55	71MF3220(1)30(2)	R71MF3220(1)30(2)
420	220	0.10	5.0	11.0	18.0	15.0	0.6	160	134,400	16.0	10	398	0.64	44	71MI3100(1)00(2)	R71MI3100(1)00(2)
420	220	0.15	5.0	11.0	18.0	15.0	0.6	160	134,400	24.0	10	371	0.66	44	71MI3150(1)00(2)	R71MI3150(1)00(2)
420	220	0.22	5.0	11.0	18.0	15.0	0.6	160	134,400	35.2	10	253	0.80	44	71MI3220(1)00(2)	R71MI3220(1)00(2)
420	220	0.33	6.0	12.0	18.0	15.0	0.6	160	134,400	52.8	10	169	0.99	43	71MI3330(1)00(2)	R71MI3330(1)00(2)
420	220	0.47	7.5	13.5	18.0	15.0	0.6	160	134,400	75.2	10	119	1.21	41	71MI3470(1)00(2)	R71MI3470(1)00(2)
420	220	0.47	6.0	17.5	18.0	15.0	0.6	160	134,400	75.2	10	119	1.26	38	71MI3470(1)10(2)	R71MI3470(1)10(2)
420	220	0.47	9.0	12.5	18.0	15.0	0.6	160	134,400	75.2	10	119	1.19	42	71MI3470(1)20(2)	R71MI3470(1)20(2)
420	220	0.68	6.0	17.5	18.0	15.0	0.6	160	134,400	108.8	10	105	1.34	38	71MI3680(1)40(2)	R71MI3680(1)40(2)
420	220	0.68	8.5	14.5	18.0	15.0	0.6	160	134,400	108.8	10	105	1.30	40	71MI3680(1)30(2)	R71MI3680(1)30(2)
420	220	0.68	13.0	12.0	18.0	15.0	0.8	160	134,400	108.8	10	105	1.26	43	71MI3680(1)20(2)	R71MI3680(1)20(2)
420	220	1.0	7.5	18.5	18.0	15.0	0.8	160	134,400	160.0	10	72	1.64	37	71MI4100(1)40(3)	R71MI4100(1)40(3)
420	220	1.0	10.0	16.0	18.0	15.0	0.8	160	134,400	160.0	10	72	1.60	39	71MI4100(1)30(2)	R71MI4100(1)30(2)
420	220	1.5	11.0	19.0	18.0	15.0	0.8	160	134,400	240.0	10	53	1.92	37	71MI4150(1)30(2)	R71MI4150(1)30(2)
420	220	0.22	6.0	15.0	26.5	22.5	0.8	100	84,000	22.0	16	326	0.86	30	71MN3220(1)00(2)	R71MN3220(1)00(2)
420	220	0.33	6.0	15.0	26.5	22.5	0.8	100	84,000	33.0	16	217	1.05	30	71MN3330(1)00(2)	R71MN3330(1)00(2)
420	220	0.47	6.0	15.0	26.5	22.5	0.8	100	84,000	47.0	16	203	1.08	30	71MN3470(1)00(2)	R71MN3470(1)00(2)
420	220	0.68	6.0	15.0	26.5	22.5	0.8	100	84,000	68.0	16	140	1.30	30	71MN3680(1)00(2)	R71MN3680(1)00(2)
420	220	1.0	7.0	16.0	26.5	22.5	0.8	100	84,000	100.0	16	95	1.60	29	71MN4100(1)30(2)	R71MN4100(1)30(2)
420	220	1.5	8.5	17.0	26.5	22.5	0.8	100	84,000	150.0	16	64	1.97	29	71MN4150(1)30(3)	R71MN4150(1)30(3)
420	220	1.5	10.0	18.5	26.5	22.5	0.8	100	84,000	150.0	16	64	2.00	28	71MN4150(1)00(2)	R71MN4150(1)00(2)
420	220	2.2	10.0	18.5	26.5	22.5	0.8	100	84,000	220.0	16	43	2.42	28	71MN4220(1)40(3)	R71MN4220(1)40(3)
420	220	2.2	11.0	20.0	26.5	22.5	0.8	100	84,000	220.0	16	43	2.45	27	71MN4220(1)30(2)	R71MN4220(1)30(2)
420	220	3.3	13.0	22.0	26.5	22.5	0.8	100	84,000	330.0	16	29	3.05	27	71MN4330(1)30(2)	R71MN4330(1)30(2)
420	220	0.68	9.0	17.0	32.0	27.5	0.8	80	67,200	54.4	18	176	1.28	25	71MR3680(1)00(2)	R71MR3680(1)00(2)
420	220	1.0	9.0	17.0	32.0	27.5	0.8	80	67,200	80.0	18	119	1.55	25	71MR4100(1)00(2)	R71MR4100(1)00(2)
420	220	1.5	11.0	20.0	32.0	27.5	0.8	80	67,200	120.0	18	80	1.94	24	71MR4150(1)00(2)	R71MR4150(1)00(2)
420	220	2.2	13.0	22.0	32.0	27.5	0.8	80	67,200	176.0	18	54	2.38	23	71MR4220(1)00(2)	R71MR4220(1)00(2)
420	220	3.3	13.0	25.0	32.0	27.5	0.8	80	67,200	264.0	18	36	2.98	22	71MR4330(1)40(2)	R71MR4330(1)40(2)
420	220	4.7	18.0	33.0	32.0	27.5	0.8	80	67,200	376.0	18	25	3.73	20	71MR4470(1)00(2)	R71MR4470(1)00(2)
420	220	6.8	22.0	37.0	32.0	27.5	0.8	80	67,200	544.0	18	18	4.58	19	71MR4680(1)00(2)	R71MR4680(1)00(2)
420	220	3.3	13.0	24.0	41.5	37.5	1.0	60	50,400	198.0	20	36	3.28	18	71MW4330(1)20(2)	R71MW4330(1)20(2)
420	220	4.7	16.0	28.5	41.5	37.5	1.0	60	50,400	282.0	20	71	2.40	17	71MW4470(1)00(2)	R71MW4470(1)00(2)
420	220	6.8	19.0	32.0	41.5	37.5	1.0	60	50,400	408.0	20	49	2.94	17	71MW4680(1)00(2)	R71MW4680(1)00(2)
420	220	10	20.0	40.0	41.5	37.5	1.0	60	50,400	600.0	20	43	3.27	16	71MW5100(1)00(2)	R71MW5100(1)00(2)
420	220	15	24.0	44.0	41.5	37.5	1.0	60	50,400	900.0	20	29	4.07	15	71MW5150(1)00(2)	R71MW5150(1)00(2)
420	220	22	30.0	45.0	41.5	37.5	1.0	60	50,400	1,320.0	20	24	4.47	15	71MW5220(1)00(2)	R71MW5220(1)00(2)
520	250	0.010	4.0	9.0	13.0	10.0	0.6	300	312,000	3.0	9	3,979	0.17	61	71VF2100(1)00(2)	R71VF2100(1)00(2)
520	250	0.015	4.0	9.0	13.0	10.0	0.6	300	312,000	4.5	9	2,653	0.21	61	71VF2150(1)00(2)	R71VF2150(1)00(2)
520	250	0.022	4.0	9.0	13.0	10.0	0.6	300	312,000	6.6	9	1,809	0.25	61	71VF2220(1)00(2)	R71VF2220(1)00(2)
520	250	0.033	4.0	9.0	13.0	10.0	0.6	300	312,000	9.9	9	1,206	0.31	61	71VF2330(1)00(2)	R71VF2330(1)00(2)
520	250	0.047	4.0	9.0	13.0	10.0	0.6	300	312,000	14.1	9	847	0.37	61	71VF2470(1)30(2)	R71VF2470(1)30(2)
520	250	0.068	4.0	9.0	13.0	10.0	0.6	300	312,000	20.4	9	585	0.45	61	71VF2680(1)30(2)	R71VF2680(1)30(2)
VDC	VAC	Cap Value	W	H	L	Lead Spacing (p)	Φd (mm)	dV/dt (V/µs)	Max K <sub>0</sub> (V <sup>2</sup> /µs)	A <sub>pk</sub>	nH	mΩ	A <sub>rms</sub>	(°C/W)	KEMET Internal Part Number	Customer Part Number
										I <sub>pk</sub>	ESL	ESR	I <sub>rms</sub> max (*)	R <sub>th</sub>		

(1) Insert lead and packaging code. See Ordering Options Table for available options.

(2) J = 5%, K = 10%, M = 20%.

(3) M = ±20% (only available tolerance).

(\*) I<sub>rms</sub> value that leads to a ΔT of ≈ 7°C on the box surface > T<sub>BOX</sub> = T<sub>AMB</sub> + ΔT = 85°C + 7°C = 92°C

**Table 1 – Ratings & Part Number Reference cont.**

VDC	VAC	Cap Value (µF)	Dimensions in mm			Lead Spacing (p)	Φd (mm)	dV/dt (V/µs)	Max K <sub>0</sub> (V <sup>2</sup> /µs)	I <sub>pk</sub>	ESL	ESR	I <sub>rms</sub> max (*)	R <sub>th</sub>	KEMET Internal Part Number	Customer Part Number
			Lead Length 2x 4 mm	at 100 kHz	at 100 kHz, 85°C						A <sub>rms</sub>	(°C/W)				
													A <sub>pk</sub>			
W	H	L	Lead Spacing (p)	Φd (mm)	dV/dt (V/µs)	Max K <sub>0</sub> (V <sup>2</sup> /µs)	A <sub>pk</sub>	nH	mΩ	A <sub>rms</sub>	(°C/W)	KEMET Internal Part Number	Customer Part Number			
520	250	0.10	5.0	11.0	13.0	10.0	0.6	300	312,000	30.0	9	398	0.56	57	71VF3100(1)30(2)	R71VF3100(1)30(2)
520	250	0.15	6.0	12.0	13.0	10.0	0.6	300	312,000	45.0	9	265	0.70	55	71VF3150(1)30(2)	R71VF3150(1)30(2)
520	250	0.10	5.0	11.0	18.0	15.0	0.6	200	208,000	20.0	10	398	0.64	44	71VI3100(1)00(2)	R71VI3100(1)00(2)
520	250	0.15	5.0	11.0	18.0	15.0	0.6	200	208,000	30.0	10	371	0.66	44	71VI3150(1)30(2)	R71VI3150(1)30(2)
520	250	0.22	6.0	12.0	18.0	15.0	0.6	200	208,000	44.0	10	253	0.81	43	71VI3220(1)30(2)	R71VI3220(1)30(2)
520	250	0.22	6.0	17.5	18.0	15.0	0.6	200	208,000	44.0	10	253	0.86	38	71VI3220(1)10(2)	R71VI3220(1)10(2)
520	250	0.33	6.0	17.5	18.0	15.0	0.6	200	208,000	66.0	10	169	1.06	38	71VI3330(1)40(2)	R71VI3330(1)40(2)
520	250	0.33	7.5	13.5	18.0	15.0	0.6	200	208,000	66.0	10	169	1.01	41	71VI3330(1)30(2)	R71VI3330(1)30(2)
520	250	0.33	9.0	12.5	18.0	15.0	0.6	200	208,000	66.0	10	169	1.00	42	71VI3330(1)20(2)	R71VI3330(1)20(2)
520	250	0.47	8.5	14.5	18.0	15.0	0.6	200	208,000	94.0	10	119	1.22	40	71VI3470(1)30(2)	R71VI3470(1)30(2)
520	250	0.47	7.5	18.5	18.0	15.0	0.8	200	208,000	94.0	10	119	1.28	37	71VI3470(1)10(2)	R71VI3470(1)10(2)
520	250	0.47	13.0	12.0	18.0	15.0	0.8	200	208,000	94.0	10	119	1.19	43	71VI3470(1)20(2)	R71VI3470(1)20(2)
520	250	0.68	10.0	16.0	18.0	15.0	0.8	200	208,000	136.0	10	105	1.32	39	71VI3680(1)30(2)	R71VI3680(1)30(2)
520	250	1.0	11.0	19.0	18.0	15.0	0.8	200	208,000	200.0	10	72	1.65	37	71VI4100(1)30(3)	R71VI4100(1)30(3)
520	250	0.22	6.0	15.0	26.5	22.5	0.8	120	124,800	26.4	16	326	0.86	30	71VN3220(1)00(2)	R71VN3220(1)00(2)
520	250	0.33	6.0	15.0	26.5	22.5	0.8	120	124,800	39.6	16	217	1.05	30	71VN3330(1)00(2)	R71VN3330(1)00(2)
520	250	0.47	6.0	15.0	26.5	22.5	0.8	120	124,800	56.4	16	203	1.08	30	71VN3470(1)30(2)	R71VN3470(1)30(2)
520	250	0.68	7.0	16.0	26.5	22.5	0.8	120	124,800	81.6	16	140	1.32	29	71VN3680(1)30(2)	R71VN3680(1)30(2)
520	250	1.0	10.0	18.5	26.5	22.5	0.8	120	124,800	120.0	16	95	1.63	28	71VN4100(1)30(2)	R71VN4100(1)30(2)
520	250	1.5	11.0	20.0	26.5	22.5	0.8	120	124,800	180.0	16	64	2.02	27	71VN4150(1)30(2)	R71VN4150(1)30(2)
520	250	2.2	13.0	22.0	26.5	22.5	0.8	120	124,800	264.0	16	43	2.49	27	71VN4220(1)30(2)	R71VN4220(1)30(2)
520	250	0.68	9.0	17.0	32.0	27.5	0.8	100	104,000	68.0	18	176	1.28	25	71VR3680(1)00(2)	R71VR3680(1)00(2)
520	250	1.0	9.0	17.0	32.0	27.5	0.8	100	104,000	100.0	18	119	1.55	25	71VR4100(1)30(2)	R71VR4100(1)30(2)
520	250	1.0	11.0	20.0	32.0	27.5	0.8	100	104,000	100.0	18	119	1.58	24	71VR4100(1)00(2)	R71VR4100(1)00(2)
520	250	1.5	11.0	20.0	32.0	27.5	0.8	100	104,000	150.0	18	80	1.94	24	71VR4150(1)00(2)	R71VR4150(1)00(2)
520	250	2.2	13.0	25.0	32.0	27.5	0.8	100	104,000	220.0	18	54	2.43	22	71VR4220(1)30(2)	R71VR4220(1)30(2)
520	250	2.2	14.0	28.0	32.0	27.5	0.8	100	104,000	220.0	18	54	2.48	21	71VR4220(1)00(2)	R71VR4220(1)00(2)
520	250	3.3	14.0	28.0	32.0	27.5	0.8	100	104,000	330.0	18	36	3.04	21	71VR4330(1)30(2)	R71VR4330(1)30(2)
520	250	3.3	18.0	33.0	32.0	27.5	0.8	100	104,000	330.0	18	36	3.12	20	71VR4330(1)00(2)	R71VR4330(1)00(2)
520	250	4.7	18.0	33.0	32.0	27.5	0.8	100	104,000	470.0	18	25	3.73	20	71VR4470(1)30(2)	R71VR4470(1)30(2)
520	250	4.7	22.0	37.0	32.0	27.5	0.8	100	104,000	470.0	18	25	3.81	19	71VR4470(1)00(2)	R71VR4470(1)00(2)
520	250	6.8	22.0	37.0	32.0	27.5	0.8	100	104,000	680.0	18	18	4.58	19	71VR4680(1)30(2)	R71VR4680(1)30(2)
520	250	2.2	11.0	22.0	41.5	37.5	1.0	70	72,800	154.0	20	54	2.65	19	71VW4220(1)00(2)	R71VW4220(1)00(2)
520	250	3.3	13.0	24.0	41.5	37.5	1.0	70	72,800	231.0	20	36	3.28	18	71VW4330(1)30(2)	R71VW4330(1)30(2)
520	250	3.3	16.0	28.5	41.5	37.5	1.0	70	72,800	231.0	20	36	3.37	17	71VW4330(1)00(2)	R71VW4330(1)00(2)
520	250	4.7	16.0	28.5	41.5	37.5	1.0	70	72,800	329.0	20	71	2.40	17	71VW4470(1)00(2)	R71VW4470(1)00(2)
520	250	6.8	19.0	32.0	41.5	37.5	1.0	70	72,800	476.0	20	49	2.94	17	71VW4680(1)30(2)	R71VW4680(1)30(2)
520	250	6.8	20.0	40.0	41.5	37.5	1.0	70	72,800	476.0	20	49	3.05	16	71VW4680(1)00(2)	R71VW4680(1)00(2)
520	250	10	20.0	40.0	41.5	37.5	1.0	70	72,800	700.0	20	43	3.27	16	71VW5100(1)30(2)	R71VW5100(1)30(2)
520	250	10	24.0	44.0	41.5	37.5	1.0	70	72,800	700.0	20	43	3.32	15	71VW5100(1)00(2)	R71VW5100(1)00(2)
520	250	15	24.0	44.0	41.5	37.5	1.0	70	72,800	1,050.0	20	29	4.07	15	71VW5150(1)30(2)	R71VW5150(1)30(2)
520	250	15	30.0	45.0	41.5	37.5	1.0	70	72,800	1,050.0	20	29	4.08	15	71VW5150(1)00(2)	R71VW5150(1)00(2)
520	250	22	30.0	45.0	41.5	37.5	1.0	70	72,800	1,540.0	20	24	4.47	15	71VW5220(1)00(2)	R71VW5220(1)00(2)
630	275	0.010	4.0	9.0	13.0	10.0	0.6	400	504,000	4.0	9	3,979	0.17	61	71PF2100(1)30(2)	R71PF2100(1)30(2)
630	275	0.015	4.0	9.0	13.0	10.0	0.6	400	504,000	6.0	9	2,653	0.21	61	71PF2150(1)30(2)	R71PF2150(1)30(2)
630	275	0.022	4.0	9.0	13.0	10.0	0.6	400	504,000	8.8	9	1,809	0.25	61	71PF2220(1)30(2)	R71PF2220(1)30(2)
630	275	0.033	5.0	11.0	13.0	10.0	0.6	400	504,000	13.2	9	1,206	0.32	57	71PF2330(1)00(2)	R71PF2330(1)00(2)
630	275	0.047	5.0	11.0	13.0	10.0	0.6	400	504,000	18.8	9	847	0.39	57	71PF2470(1)30(2)	R71PF2470(1)30(2)
630	275	0.068	6.0	12.0	13.0	10.0	0.6	400	504,000	27.2	9	585	0.47	55	71PF2680(1)30(2)	R71PF2680(1)30(2)
630	275	0.10	6.0	12.0	13.0	10.0	0.6	400	504,000	40.0	9	398	0.57	55	71PF3100(1)30(3)	R71PF3100(1)30(3)
630	275	0.010	5.0	11.0	18.0	15.0	0.6	250	315,000	2.5	10	3,979	0.20	44	71PI2100(1)00(2)	R71PI2100(1)00(2)
VDC	VAC	Cap Value	W	H	L	Lead Spacing (p)	Φd (mm)	dV/dt (V/µs)	Max K <sub>0</sub> (V <sup>2</sup> /µs)	A <sub>pk</sub>	nH	mΩ	A <sub>rms</sub>	(°C/W)	KEMET Internal Part Number	Customer Part Number
										I <sub>pk</sub>	ESL	ESR	I <sub>rms</sub> max (*)	R <sub>th</sub>		

(1) Insert lead and packaging code. See Ordering Options Table for available options.

(2) J = 5%, K = 10%, M = 20%.

(3) M = ±20% (only available tolerance).

(\*) I<sub>rms</sub> value that leads to a ΔT of ≈ 7°C on the box surface > T<sub>BOX</sub> = T<sub>AMB</sub> + ΔT = 85°C + 7°C = 92°C

**Table 1 – Ratings & Part Number Reference cont.**

VDC	VAC	Cap Value (µF)	Dimensions in mm			Lead Spacing (p)	Φd (mm)	dV/dt (V/µs)	Max K <sub>0</sub> (V <sup>2</sup> /µs)	I <sub>pk</sub>	ESL	ESR	I <sub>rms</sub> max (*)	R <sub>th</sub>	KEMET Internal Part Number	Customer Part Number
			Lead Length 2x 4 mm	at 100 kHz	at 100 kHz, 85°C						R <sub>th</sub>					
												A <sub>pk</sub>	nH			
W	H	L	A <sub>pk</sub>	nH	mΩ	A <sub>rms</sub>	(°C/W)									
630	275	0.015	5.0	11.0	18.0	15.0	0.6	250	315,000	3.8	10	2,653	0.25	44	71PI2150(1)00(2)	R71PI2150(1)00(2)
630	275	0.022	5.0	11.0	18.0	15.0	0.6	250	315,000	5.5	10	1,809	0.30	44	71PI2220(1)00(2)	R71PI2220(1)00(2)
630	275	0.033	5.0	11.0	18.0	15.0	0.6	250	315,000	8.3	10	1,206	0.37	44	71PI2330(1)00(2)	R71PI2330(1)00(2)
630	275	0.047	5.0	11.0	18.0	15.0	0.6	250	315,000	11.8	10	847	0.44	44	71PI2470(1)00(2)	R71PI2470(1)00(2)
630	275	0.068	5.0	11.0	18.0	15.0	0.6	250	315,000	17.0	10	585	0.53	44	71PI2680(1)00(2)	R71PI2680(1)00(2)
630	275	0.10	5.0	11.0	18.0	15.0	0.6	250	315,000	25.0	10	398	0.64	44	71PI3100(1)30(2)	R71PI3100(1)30(2)
630	275	0.15	6.0	12.0	18.0	15.0	0.6	250	315,000	37.5	10	371	0.67	43	71PI3150(1)30(2)	R71PI3150(1)30(2)
630	275	0.15	6.0	17.5	18.0	15.0	0.6	250	315,000	37.5	10	371	0.71	38	71PI3150(1)40(2)	R71PI3150(1)40(2)
630	275	0.22	7.5	13.5	18.0	15.0	0.6	250	315,000	55.0	10	253	0.83	41	71PI3220(1)30(2)	R71PI3220(1)30(2)
630	275	0.22	6.0	17.5	18.0	15.0	0.6	250	315,000	55.0	10	253	0.86	38	71PI3220(1)10(2)	R71PI3220(1)10(2)
630	275	0.22	9.0	12.5	18.0	15.0	0.6	250	315,000	55.0	10	253	0.82	42	71PI3220(1)20(2)	R71PI3220(1)20(2)
630	275	0.33	8.5	14.5	18.0	15.0	0.6	250	315,000	82.5	10	169	1.02	40	71PI3330(1)30(2)	R71PI3330(1)30(2)
630	275	0.33	7.5	18.5	18.0	15.0	0.8	250	315,000	82.5	10	169	1.07	37	71PI3330(1)10(2)	R71PI3330(1)10(2)
630	275	0.33	9.0	12.5	18.0	15.0	0.6	250	315,000	82.5	10	169	1.00	42	71PI3330(1)40(3)	R71PI3330(1)40(3)
630	275	0.33	13.0	12.0	18.0	15.0	0.8	250	315,000	82.5	10	169	0.99	43	71PI3330(1)20(2)	R71PI3330(1)20(2)
630	275	0.47	7.5	18.5	18.0	15.0	0.8	250	315,000	117.5	10	119	1.28	37	71PI3470(1)40(3)	R71PI3470(1)40(3)
630	275	0.47	10.0	16.0	18.0	15.0	0.8	250	315,000	117.5	10	119	1.24	39	71PI3470(1)30(3)	R71PI3470(1)30(3)
630	275	0.68	11.0	19.0	18.0	15.0	0.8	250	315,000	170.0	10	105	1.36	37	71PI3680(1)30(3)	R71PI3680(1)30(3)
630	275	0.15	6.0	15.0	26.5	22.5	0.8	160	201,600	24.0	16	477	0.71	30	71PN3150(1)00(2)	R71PN3150(1)00(2)
630	275	0.22	6.0	15.0	26.5	22.5	0.8	160	201,600	35.2	16	326	0.86	30	71PN3220(1)00(2)	R71PN3220(1)00(2)
630	275	0.33	6.0	15.0	26.5	22.5	0.8	160	201,600	52.8	16	217	1.05	30	71PN3330(1)30(2)	R71PN3330(1)30(2)
630	275	0.47	7.0	16.0	26.5	22.5	0.8	160	201,600	75.2	16	203	1.09	29	71PN3470(1)30(2)	R71PN3470(1)30(2)
630	275	0.68	10.0	18.5	26.5	22.5	0.8	160	201,600	108.8	16	140	1.35	28	71PN3680(1)30(2)	R71PN3680(1)30(2)
630	275	1.0	10.0	18.5	26.5	22.5	0.8	160	201,600	160.0	16	95	1.63	28	71PN4100(1)40(3)	R71PN4100(1)40(3)
630	275	1.0	11.0	20.0	26.5	22.5	0.8	160	201,600	160.0	16	95	1.65	27	71PN4100(1)30(2)	R71PN4100(1)30(2)
630	275	0.68	9.0	17.0	32.0	27.5	0.8	115	144,900	78.2	18	176	1.28	25	71PR3680(1)00(2)	R71PR3680(1)00(2)
630	275	1.0	11.0	20.0	32.0	27.5	0.8	115	144,900	115.0	18	119	1.58	24	71PR4100(1)00(2)	R71PR4100(1)00(2)
630	275	1.5	13.0	22.0	32.0	27.5	0.8	115	144,900	172.5	18	80	1.97	23	71PR4150(1)00(2)	R71PR4150(1)00(2)
630	275	2.2	14.0	28.0	32.0	27.5	0.8	115	144,900	253.0	18	54	2.48	21	71PR4220(1)00(2)	R71PR4220(1)00(2)
630	275	3.3	18.0	33.0	32.0	27.5	0.8	115	144,900	379.5	18	36	3.12	20	71PR4330(1)00(2)	R71PR4330(1)00(2)
630	275	4.7	22.0	37.0	32.0	27.5	0.8	115	144,900	540.5	18	25	3.81	19	71PR4470(1)00(2)	R71PR4470(1)00(2)
630	275	1.5	11.0	22.0	41.5	37.5	1.0	80	100,800	120.0	20	80	2.19	19	71PW4150(1)00(2)	R71PW4150(1)00(2)
630	275	2.2	13.0	24.0	41.5	37.5	1.0	80	100,800	176.0	20	54	2.68	18	71PW4220(1)00(2)	R71PW4220(1)00(2)
630	275	3.3	16.0	28.5	41.5	37.5	1.0	80	100,800	264.0	20	36	3.37	17	71PW4330(1)00(2)	R71PW4330(1)00(2)
630	275	4.7	19.0	32.0	41.5	37.5	1.0	80	100,800	376.0	20	71	2.45	17	71PW4470(1)00(2)	R71PW4470(1)00(2)
630	275	6.8	20.0	40.0	41.5	37.5	1.0	80	100,800	544.0	20	49	3.05	16	71PW4680(1)00(2)	R71PW4680(1)00(2)
630	275	10	24.0	44.0	41.5	37.5	1.0	80	100,800	800.0	20	43	3.32	15	71PW5100(1)00(2)	R71PW5100(1)00(2)
630	275	15	30.0	45.0	41.5	37.5	1.0	80	100,800	1,200.0	20	29	4.08	15	71PW5150(1)00(2)	R71PW5150(1)00(2)
1,000	275	0.22	9.0	17.0	32.0	27.5	0.8	180	360,000	39.6	18	543	0.73	25	71QR3220(1)00(2)	R71QR3220(1)00(2)
1,000	275	0.27	9.0	17.0	32.0	27.5	0.8	180	360,000	48.6	18	442	0.80	25	71QR3270(1)00(2)	R71QR3270(1)00(2)
1,000	275	0.33	9.0	17.0	32.0	27.5	0.8	180	360,000	59.4	18	362	0.89	25	71QR3330(1)10(2)	R71QR3330(1)10(2)
1,000	275	0.33	11.0	20.0	32.0	27.5	0.8	180	360,000	59.4	18	362	0.91	24	71QR3330(1)00(2)	R71QR3330(1)00(2)
1,000	275	0.39	9.0	17.0	32.0	27.5	0.8	180	360,000	70.2	18	306	0.97	25	71QR3390(1)10(2)	R71QR3390(1)10(2)
1,000	275	0.39	11.0	20.0	32.0	27.5	0.8	180	360,000	70.2	18	306	0.99	24	71QR3390(1)00(2)	R71QR3390(1)00(2)
1,000	275	0.47	9.0	17.0	32.0	27.5	0.8	180	360,000	84.6	18	254	1.06	25	71QR3470(1)10(2)	R71QR3470(1)10(2)
1,000	275	0.47	13.0	22.0	32.0	27.5	0.8	180	360,000	84.6	18	254	1.10	23	71QR3470(1)00(2)	R71QR3470(1)00(2)
1,000	275	0.56	9.0	17.0	32.0	27.5	0.8	180	360,000	100.8	18	213	1.16	25	71QR3560(1)10(2)	R71QR3560(1)10(2)
1,000	275	0.56	13.0	22.0	32.0	27.5	0.8	180	360,000	100.8	18	213	1.20	23	71QR3560(1)00(2)	R71QR3560(1)00(2)
1,000	275	0.68	11.0	20.0	32.0	27.5	0.8	180	360,000	122.4	18	176	1.31	24	71QR3680(1)10(2)	R71QR3680(1)10(2)
1,000	275	0.68	14.0	28.0	32.0	27.5	0.8	180	360,000	122.4	18	176	1.38	21	71QR3680(1)00(2)	R71QR3680(1)00(2)
1,000	275	0.82	11.0	20.0	32.0	27.5	0.8	180	360,000	147.6	18	146	1.43	24	71QR3820(1)10(2)	R71QR3820(1)10(2)
VDC	VAC	Cap Value	W	H	L	Lead Spacing (p)	Φd (mm)	dV/dt (V/µs)	Max K <sub>0</sub> (V <sup>2</sup> /µs)	A <sub>pk</sub>	nH	mΩ	A <sub>rms</sub>	(°C/W)	KEMET Internal Part Number	Customer Part Number
										I <sub>pk</sub>	ESL	ESR	I <sub>rms</sub> max (*)	R <sub>th</sub>		

(1) Insert lead and packaging code. See Ordering Options Table for available options.

(2) J = 5%, K = 10%, M = 20%.

(3) M = ±20% (only available tolerance).

(\*) I<sub>rms</sub> value that leads to a ΔT of ≈ 7°C on the box surface > T<sub>BOX</sub> = T<sub>AMB</sub> + ΔT = 85°C + 7°C = 92°C

**Table 1 – Ratings & Part Number Reference cont.**

VDC	VAC	Cap Value (µF)	Dimensions in mm			Lead Spacing (p)	Φd (mm)	dV/dt (V/µs)	Max K <sub>0</sub> (V <sup>2</sup> /µs)	I <sub>pk</sub>	ESL	ESR	I <sub>rms</sub> max (*)	R <sub>th</sub>	KEMET Internal Part Number	Customer Part Number
											Lead Length 2x 4 mm	at 100 kHz	at 100 kHz, 85°C			
			A <sub>pk</sub>	nH	mΩ						A <sub>rms</sub>	(°C/W)				
1,000	275	0.82	14.0	28.0	32.0	27.5	0.8	180	360,000	147.6	18	146	1.51	21	71QR3820(1)00(2)	R71QR3820(1)00(2)
1,000	275	1.0	13.0	22.0	32.0	27.5	0.8	180	360,000	180.0	18	119	1.61	23	71QR4100(1)10(2)	R71QR4100(1)10(2)
1,000	275	1.0	18.0	33.0	32.0	27.5	0.8	180	360,000	180.0	18	119	1.72	20	71QR4100(1)00(2)	R71QR4100(1)00(2)
1,000	275	1.2	13.0	25.0	32.0	27.5	0.8	180	360,000	216.0	18	99	1.80	22	71QR4120(1)10(2)	R71QR4120(1)10(2)
1,000	275	1.2	18.0	33.0	32.0	27.5	0.8	180	360,000	216.0	18	99	1.88	20	71QR4120(1)00(2)	R71QR4120(1)00(2)
1,000	275	1.5	14.0	28.0	32.0	27.5	0.8	180	360,000	270.0	18	80	2.05	21	71QR4150(1)10(2)	R71QR4150(1)10(2)
1,000	275	1.5	18.0	33.0	32.0	27.5	0.8	180	360,000	270.0	18	80	2.11	20	71QR4150(1)00(2)	R71QR4150(1)00(2)
1,000	275	1.8	14.0	28.0	32.0	27.5	0.8	180	360,000	324.0	18	66	2.24	21	71QR4180(1)10(2)	R71QR4180(1)10(2)
1,000	275	1.8	22.0	37.0	32.0	27.5	0.8	180	360,000	324.0	18	66	2.36	19	71QR4180(1)00(2)	R71QR4180(1)00(2)
1,000	275	2.2	18.0	33.0	32.0	27.5	0.8	180	360,000	396.0	18	54	2.55	20	71QR4220(1)10(2)	R71QR4220(1)10(2)
1,000	275	2.2	22.0	37.0	32.0	27.5	0.8	180	360,000	396.0	18	54	2.60	19	71QR4220(1)00(2)	R71QR4220(1)00(2)
1,000	275	2.7	18.0	33.0	32.0	27.5	0.8	180	360,000	486.0	18	44	2.83	20	71QR4270(1)10(2)	R71QR4270(1)10(2)
1,000	275	3.3	22.0	37.0	32.0	27.5	0.8	180	360,000	594.0	18	36	3.19	19	71QR4330(1)10(2)	R71QR4330(1)10(2)
1,000	275	3.9	22.0	37.0	32.0	27.5	0.8	180	360,000	702.0	18	31	3.47	19	71QR4390(1)10(2)	R71QR4390(1)10(2)
1,000	275	0.68	11.0	22.0	41.5	37.5	1.0	150	300,000	102.0	20	176	1.47	19	71QW3680(1)00(2)	R71QW3680(1)00(2)
1,000	275	0.82	13.0	24.0	41.5	37.5	1.0	150	300,000	123.0	20	146	1.64	18	71QW3820(1)00(2)	R71QW3820(1)00(2)
1,000	275	1.0	11.0	22.0	41.5	37.5	1.0	150	300,000	150.0	20	119	1.79	19	71QW4100(1)10(2)	R71QW4100(1)10(2)
1,000	275	1.0	13.0	24.0	41.5	37.5	1.0	150	300,000	150.0	20	119	1.81	18	71QW4100(1)00(2)	R71QW4100(1)00(2)
1,000	275	1.2	11.0	22.0	41.5	37.5	1.0	150	300,000	180.0	20	99	1.96	19	71QW4120(1)10(2)	R71QW4120(1)10(2)
1,000	275	1.2	16.0	28.5	41.5	37.5	1.0	150	300,000	180.0	20	99	2.03	17	71QW4120(1)00(2)	R71QW4120(1)00(2)
1,000	275	1.5	11.0	22.0	41.5	37.5	1.0	150	300,000	225.0	20	80	2.19	19	71QW4150(1)10(2)	R71QW4150(1)10(2)
1,000	275	1.5	16.0	28.5	41.5	37.5	1.0	150	300,000	225.0	20	80	2.27	17	71QW4150(1)00(2)	R71QW4150(1)00(2)
1,000	275	1.8	13.0	24.0	41.5	37.5	1.0	150	300,000	270.0	20	66	2.43	18	71QW4180(1)10(2)	R71QW4180(1)10(2)
1,000	275	1.8	19.0	32.0	41.5	37.5	1.0	150	300,000	270.0	20	66	2.53	17	71QW4180(1)00(2)	R71QW4180(1)00(2)
1,000	275	2.2	16.0	28.5	41.5	37.5	1.0	120	240,000	264.0	20	54	2.75	17	71QW4220(1)10(2)	R71QW4220(1)10(2)
1,000	275	2.2	20.0	40.0	41.5	37.5	1.0	120	240,000	264.0	20	54	2.91	16	71QW4220(1)20(2)	R71QW4220(1)20(2)
1,000	275	2.7	16.0	28.5	41.5	37.5	1.0	120	240,000	324.0	20	44	3.05	17	71QW4270(1)10(2)	R71QW4270(1)10(2)
1,000	275	2.7	24.0	44.0	41.5	37.5	1.0	120	240,000	324.0	20	44	3.27	15	71QW4270(1)20(2)	R71QW4270(1)20(2)
1,000	275	3.3	19.0	32.0	41.5	37.5	1.0	120	240,000	396.0	20	36	3.43	17	71QW4330(1)10(2)	R71QW4330(1)10(2)
1,000	275	3.3	24.0	44.0	41.5	37.5	1.0	120	240,000	396.0	20	36	3.62	15	71QW4330(1)00(2)	R71QW4330(1)00(2)
1,000	275	3.9	19.0	32.0	41.5	37.5	1.0	120	240,000	468.0	20	86	2.23	17	71QW4390(1)10(2)	R71QW4390(1)10(2)
1,000	275	3.9	24.0	44.0	41.5	37.5	1.0	120	240,000	468.0	20	86	2.35	15	71QW4390(1)00(2)	R71QW4390(1)00(2)
1,000	275	4.7	20.0	40.0	41.5	37.5	1.0	80	160,000	376.0	20	71	2.54	16	71QW4470(1)10(2)	R71QW4470(1)10(2)
1,000	275	4.7	24.0	44.0	41.5	37.5	1.0	80	160,000	376.0	20	71	2.58	15	71QW4470(1)00(2)	R71QW4470(1)00(2)
1,000	275	5.6	24.0	44.0	41.5	37.5	1.0	80	160,000	448.0	20	60	2.82	15	71QW4560(1)20(2)	R71QW4560(1)20(2)
1,000	275	5.6	30.0	45.0	41.5	37.5	1.0	80	160,000	448.0	20	60	2.83	15	71QW4560(1)00(2)	R71QW4560(1)00(2)
1,000	275	6.8	24.0	44.0	41.5	37.5	1.0	80	160,000	544.0	20	49	3.11	15	71QW4680(1)10(2)	R71QW4680(1)10(2)
1,000	275	8.2	24.0	44.0	41.5	37.5	1.0	80	160,000	656.0	20	52	3.01	15	71QW4820(1)10(2)	R71QW4820(1)10(2)
1,000	275	10.0	30.0	45.0	41.5	37.5	1.0	80	160,000	800.0	20	43	3.33	15	71QW5100(1)10(2)	R71QW5100(1)10(2)
VDC	VAC	Cap Value	W	H	L	Lead Spacing (p)	Φd (mm)	dV/dt (V/µs)	Max K <sub>0</sub> (V <sup>2</sup> /µs)	A <sub>pk</sub>	nH	mΩ	A <sub>rms</sub>	(°C/W)	KEMET Internal Part Number	Customer Part Number
										I <sub>pk</sub>	ESL	ESR	I <sub>rms</sub> max (*)	R <sub>th</sub>		

(1) Insert lead and packaging code. See Ordering Options Table for available options.

(2) J = 5%, K = 10%, M = 20%.

(3) M = ±20% (only available tolerance).

(\*) I<sub>rms</sub> value that leads to a ΔT of ≈ 7°C on the box surface > T<sub>BOX</sub> = T<sub>AMB</sub> + ΔT = 85°C + 7°C = 92°C

## Soldering Process

The implementation of the RoHS directive has resulted in the selection of SnAgCu (SAC) alloys or SnCu alloys as a primary solder. This has increased the liquidus temperature from that of 183°C for SnPb eutectic alloy to 217 – 221°C for the new alloys. As a result, the heat stress to the components, even in wave soldering, has increased considerably due to higher pre-heat and wave temperatures. Polypropylene capacitors are especially sensitive to heat (the melting point of polypropylene is 160 – 170°C). Wave soldering can be destructive, especially for mechanically small polypropylene capacitors (with lead spacing of 5 mm to 15 mm), and great care has to be taken during soldering. The recommended solder profiles from KEMET should be used. Please consult KEMET with any questions. In general, the wave soldering curve from IEC Publication 61760–1 Edition 2 serves as a solid guideline for successful soldering. Please see Figure 1.

Reflow soldering is not recommended for through-hole film capacitors. Exposing capacitors to a soldering profile in excess of the above recommended limits may result in degradation or permanent damage to the capacitors.

Do not place the polypropylene capacitor through an adhesive curing oven to cure resin for surface mount components. Insert through-hole parts after the curing of surface mount parts. Consult KEMET to discuss the actual temperature profile in the oven, if through-hole components must pass through the adhesive curing process. A maximum two soldering cycles is recommended. Please allow time for the capacitor surface temperature to return to a normal temperature before the second soldering cycle.

### Manual Soldering Recommendations

The following is recommended for manual soldering with a soldering iron.

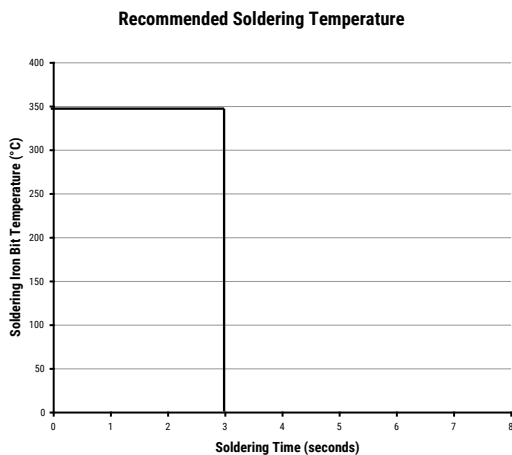

The soldering iron tip temperature should be set at 350°C (+10°C maximum) with the soldering duration not to exceed more than 3 seconds.

### Wave Soldering Recommendations

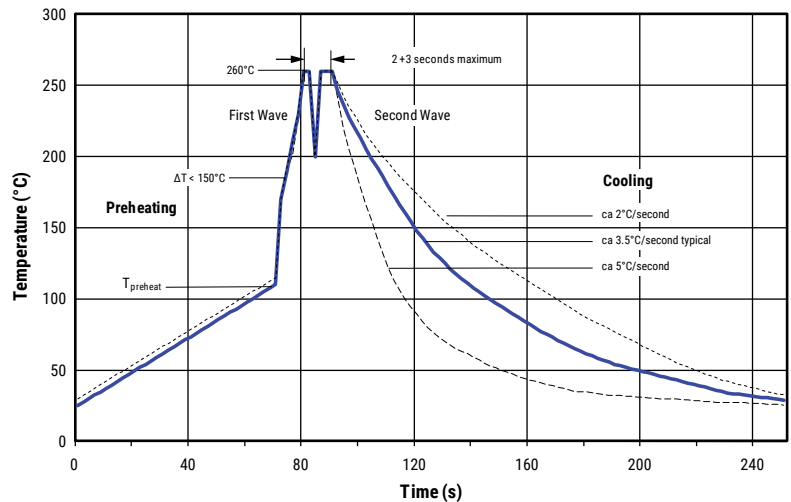

## Soldering Process cont.

### Wave Soldering Recommendations cont.

1. The table indicates the maximum set-up temperature of the soldering process  
 Figure 1.

Dielectric Film Material	Maximum Preheat Temperature		Maximum Peak Soldering Temperature	
	Capacitor Pitch ≤ 15 mm	Capacitor Pitch > 15 mm	Capacitor Pitch ≤ 15 mm	Capacitor Pitch > 15 mm
Polyester	130°C	130°C	270°C	270°C
Polypropylene	110°C	130°C	260°C	270°C
Paper	130°C	140°C	270°C	270°C
Polyphenylene Sulphide	150°C	160°C	270°C	270°C

2. The maximum temperature measured inside the capacitor:

Set the temperature so that inside the element the maximum temperature is below the limit:

Dielectric Film Material	Maximum temperature measured inside the element
Polyester	160°C
Polypropylene	110°C
Paper	160°C
Polyphenylene Sulphide	160°C

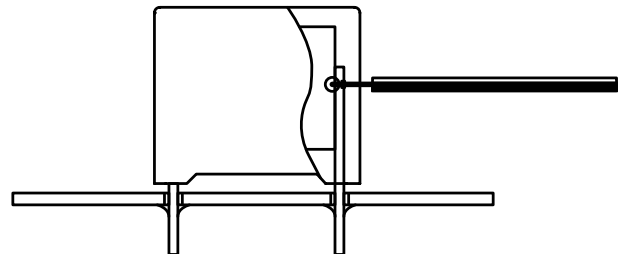

*Temperature monitored inside the capacitor.*

### Selective Soldering Recommendations

Selective dip soldering is a variation of reflow soldering. In this method, the printed circuit board with through-hole components to be soldered is preheated and transported over the solder bath as in normal flow soldering without touching the solder. When the board is over the bath, it is stopped and pre-designed solder pots are lifted from the bath with molten solder only at the places of the selected components, and pressed against the lower surface of the board to solder the components.

The temperature profile for selective soldering is similar to the double wave flow soldering outlined in this document, **however, instead of two baths, there is only one bath with a time from 3 to 10 seconds.** In selective soldering, the risk of overheating is greater than in double wave flow soldering. Great care must be taken so that the parts are not overheated.



## Construction

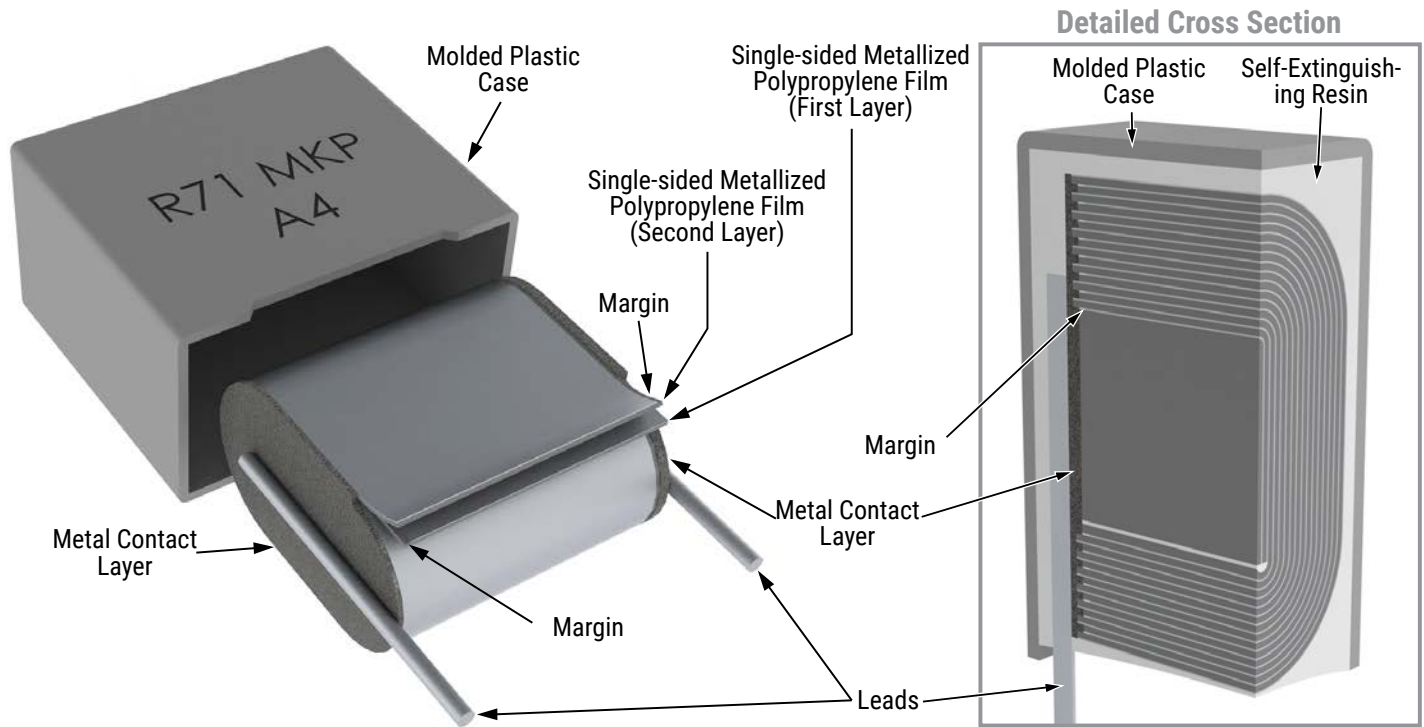

## Winding Scheme

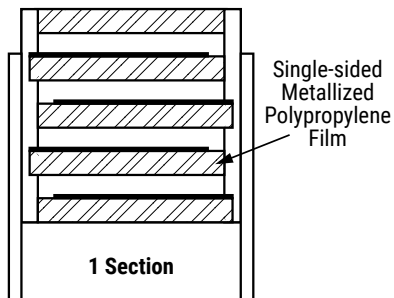

## Marking

Pitch – 7.5, 10, 15 & 22.5

Marking Variants\*

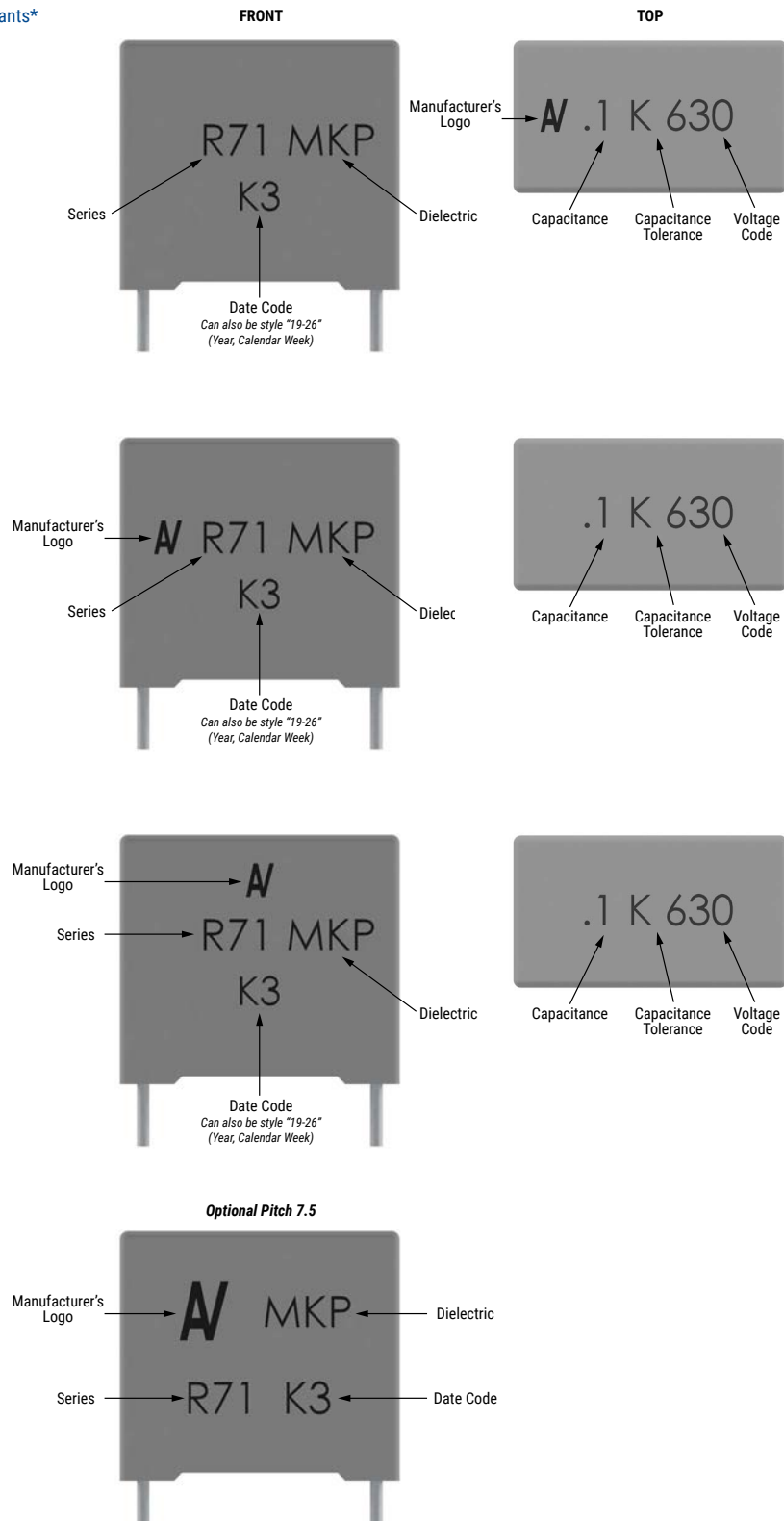

\* Differences are caused by technology (Clichee or ink) and technic (production line).



## Marking cont.

Pitch – 7.5, 10, 15, 22.5, 27.5 & 37.5

Marking Variants\*

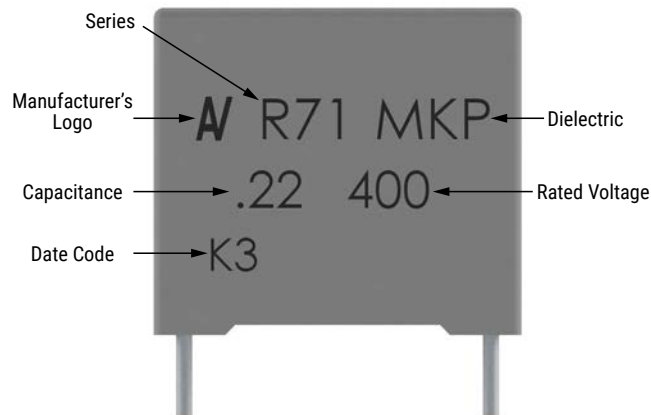
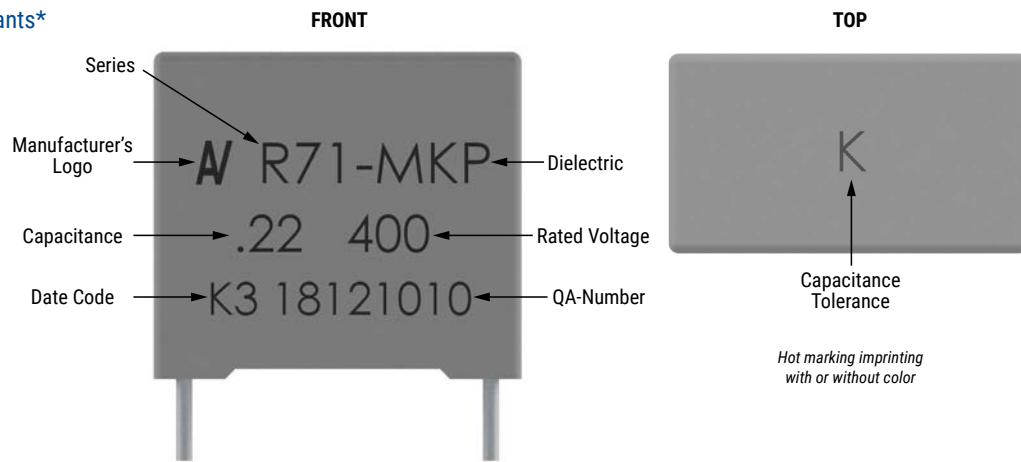

Pitch – 22.5, 27.5 & 37.5

Marking Variants\*

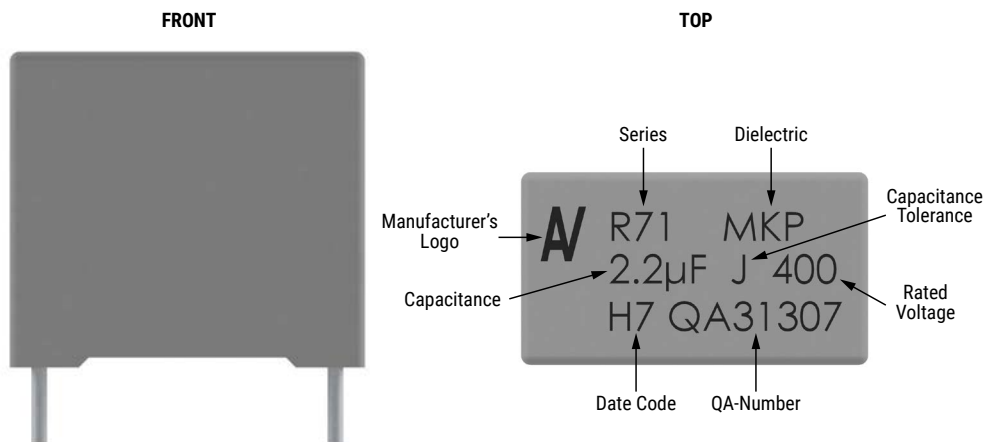

\* Differences are caused by technology (Clichee or ink) and technic (production line).

## Packaging Quantities

Lead Spacing	Thickness (mm)	Height (mm)	Length (mm)	Bulk Short Leads	Bulk Long Leads		Standard Reel ø 355 mm	Large Reel ø 500 mm	Ammo Taped
	Lead and Packaging Code			AA - JB JE - JH	JM	40 - 50	GY	CK	DQ
10	4.0	9.0	13.0	2,000	2,200	1,800	750	1,500	1,000
	5.0	11.0	13.0	1,300	2,000	1,500	600	1,250	800
	6.0	12.0	13.0	1,000	1,800	1,200	500	1,000	680
15	5.0	11.0	18.0	2,000	1,250	1,000	600	1,250	800
	6.0	12.0	18.0	1,750	1,000	900	500	1,000	680
	6.0	17.5	18.0	1,000	1500	700	500	1,000	680
	7.5	13.5	18.0	1,000	800	700	350	800	500
	7.5	18.5	18.0	900	650	500	350	800	500
	8.5	14.5	18.0	1,000	650	500	300	700	440
	9.0	12.5	18.0	1,000	700	520	270	650	410
	10.0	16.0	18.0	750	550	500	300	600	380
	11.0	19.0	18.0	450	400	350	270	500	340
	13.0	12.0	18.0	750	520	490	200	480	280
22.5	6.0	15.0	26.5	805	450	500	300	700	464
	7.0	16.0	26.5	700	450	500	250	550	380
	8.5	17.0	26.5	468	350	300	250	450	280
	10.0	18.5	26.5	396	350	300	160	350	235
	11.0	20.0	26.5	360	200	250	160	350	217
	13.0	22.0	26.5	300	200	200	130	300	-
27.5	9.0	17.0	32.0	816	-	408	230	450	-
	11.0	20.0	32.0	560	-	336	190	350	-
	13.0	12.0	32.0	672	-	288	-	-	-
	13.0	22.0	32.0	480	-	288	150	300	-
	13.0	25.0	32.0	480	-	288	-	-	-
	14.0	28.0	32.0	352	-	176	-	-	-
	18.0	33.0	32.0	256	-	128	-	-	-
	22.0	37.0	32.0	168	-	112	-	-	-
	24.0	15.0	32.0	336	-	144	-	-	-
37.5	11.0	22.0	41.5	420	-	252	-	-	-
	13.0	24.0	41.5	360	-	216	-	-	-
	16.0	28.5	41.5	216	-	108	-	-	-
	19.0	32.0	41.5	192	-	96	-	-	-
	20.0	40.0	41.5	126	-	84	-	-	-
	24.0	15.0	41.5	252	-	108	-	-	-
	24.0	19.0	41.5	216	-	108	-	-	-
	24.0	44.0	41.5	108	-	72	-	-	-
		30.0	45.0	41.5	90	-	60	-	-

## Lead Taping & Packaging (IEC 60286-2)

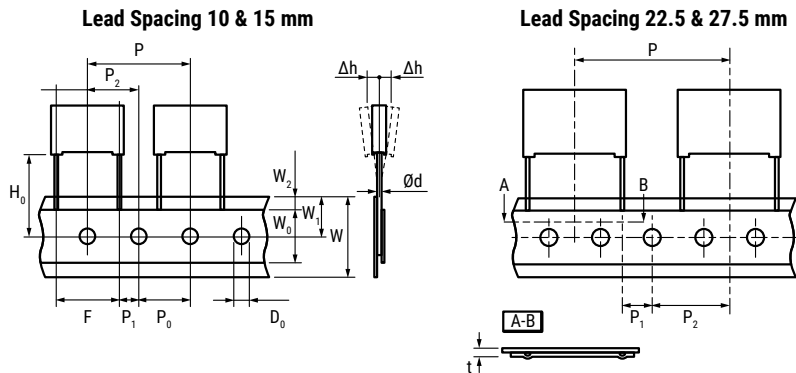

## Taping Specification

Description	Symbol	Dimensions (mm)					Tolerance
		Lead Spacing					
		10.0	15.0	22.5	27.5		
Lead wire diameter	d	0.6	0.6 – 0.8	0.8	0.8	±0.05	
Taping lead space	P	25.4	25.4	38.1	38.1	±1	
Feed hole lead space *	P <sub>0</sub>	12.7	12.7	12.7	12.7	±0.2 **	
Centering of the lead wire	P <sub>1</sub>	7.7	5.2	7.8	5.3	±0.7	
Centering of the body	P <sub>2</sub>	12.7	12.7	19.05	19.05	±1.3	
Lead spacing ***	F	10.0	15.0	22.5	27.5	+0.6/-0.1	
Component alignment	Δh	0	0	0	0	±2	
Component deviation	Δp	0	0	0	0	±1	
Height of component from tape center	H <sub>0</sub> ****	18.5	18.5	18.5	18.5	±0.5	
Carrier tape width	W	18	18	18	18	+1/-0.5	
Hold down tape width	W <sub>0</sub>	9	10	10	10	Minimum	
Hole position	W <sub>1</sub>	9	9	9	9	±0.5	
Hold down tape position	W <sub>2</sub>	3	3	3	3	Maximum	
Feed hole diameter	D <sub>0</sub>	4	4	4	4	±0.2	
Total tape thickness	t	0.7	0.7	0.7	0.7	±0.2	

\* Available also 15 mm.

\*\* Maximum 1 mm on 20 lead spacing.

\*\*\* 15 mm and 10 mm taped to 7.5 mm (crimped leads) available upon request.

\*\*\*\* H<sub>0</sub> = 16.5 mm is available upon request.

## Lead Taping & Packaging (IEC 60286-2) cont.

### Ammo Specifications

Dimensions (mm)		
H	W	T
360	340	59

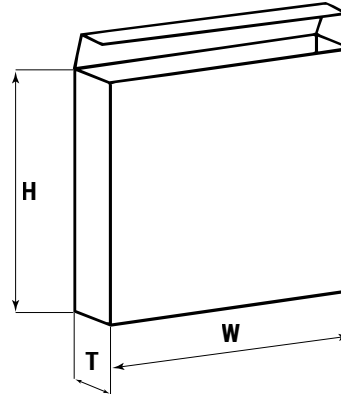

### Reel Specifications

Dimensions (mm)		
D	H	W
355	30	55 Maximum
500	25	

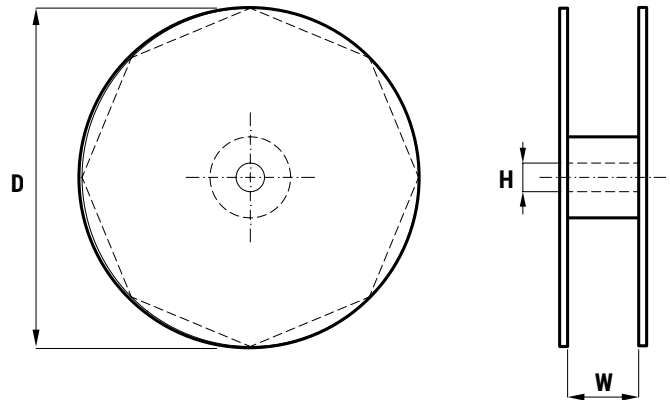

### Manufacturing Date Code (IEC-60062)

Y = Year, Z = Month			
Year	Code	Month	Code
2010	A	January	1
2011	B	February	2
2012	C	March	3
2013	D	April	4
2014	E	May	5
2015	F	June	6
2016	H	July	7
2017	J	August	8
2018	K	September	9
2019	L	October	0
2020	M	November	N
2021	N	December	D
2022	P		
2023	R		
2024	S		
2025	T		
2026	U		
2027	V		
2028	W		
2029	X		
2030	A		

## KEMET Electronics Corporation Sales Offices

For a complete list of our global sales offices, please visit [www.kemet.com/sales](http://www.kemet.com/sales).

---

### Disclaimer

All product specifications, statements, information and data (collectively, the "Information") in this datasheet are subject to change. The customer is responsible for checking and verifying the extent to which the Information contained in this publication is applicable to an order at the time the order is placed. All Information given herein is believed to be accurate and reliable, but it is presented without guarantee, warranty, or responsibility of any kind, expressed or implied.

Statements of suitability for certain applications are based on KEMET Electronics Corporation's ("KEMET") knowledge of typical operating conditions for such applications, but are not intended to constitute – and KEMET specifically disclaims – any warranty concerning suitability for a specific customer application or use. The Information is intended for use only by customers who have the requisite experience and capability to determine the correct products for their application. Any technical advice inferred from this Information or otherwise provided by KEMET with reference to the use of KEMET's products is given gratis, and KEMET assumes no obligation or liability for the advice given or results obtained.

Although KEMET designs and manufactures its products to the most stringent quality and safety standards, given the current state of the art, isolated component failures may still occur. Accordingly, customer applications which require a high degree of reliability or safety should employ suitable designs or other safeguards (such as installation of protective circuitry or redundancies) in order to ensure that the failure of an electrical component does not result in a risk of personal injury or property damage.

Although all product-related warnings, cautions and notes must be observed, the customer should not assume that all safety measures are indicated or that other measures may not be required.

*KEMET is a registered trademark of KEMET Electronics Corporation.*

单击下面可查看定价，库存，交付和生命周期等信息

[>>KEMET\(基美\)](#)