

Polypropylene Pulse/High Frequency Capacitors  
**R73, Polypropylene Film/Foil, Radial  
 (Automotive Grade)**

**Overview**

The R73 Series is constructed of polypropylene film and metal foil or metallized film and metal foil with radial leads of tinned wire. The radial leads are electrically welded to the metal layer on the ends of the capacitor winding. The capacitor is encapsulated in a self-extinguishing solvent resistant plastic case with thermosetting resin material meeting the UL 94 V-0 requirements. Two different winding constructions are used depending on voltage parameters. Please see the Performance Characteristics for more information.

Automotive grade devices (up to lead spacing 22.5 mm) meet the demanding Automotive Electronics Council's AEC-Q200 qualification requirements.

**Applications**

Typical applications include resonant circuit, high frequency high current, snubber and silicon-controlled rectifier (SCR and IGBT) and SiC (e.g. MOSFET) commutation circuits as well as applications with high voltage and high current. Not suitable for across-the-line application (see Suppressor Capacitors).

**Benefits**

- Voltage range: 100 – 2,000 VDC
- Capacitance range: 100 pF – 2.2 μF
- Lead Spacing: 15 – 37.5 mm
- Capacitance tolerance: ±2.5% (for 2-section construction only) ±5%, ±10%
- Climatic category: 55/105/56 IEC 60068-1
- Operating temperature range of -55°C to +105°C
- RoHS compliance and lead-free terminations
- Tape & Reel packaging in accordance with IEC 60286-2
- Self-healing
- Automotive (AEC-Q200) grades available up to lead spacing 22.5 mm

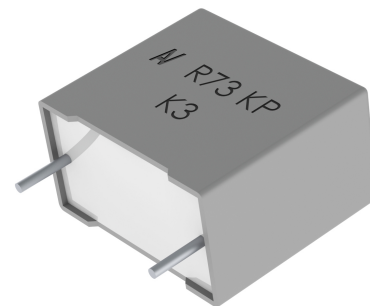

**Part Number System**

| R73                     | E   | I  | 2470   | AA                         | 00                         | H  |
|-------------------------|---|--|--|----------------------------|----------------------------|--|
| Series                  | Rated Voltage (VDC)   | Lead Spacing (mm)                            | Capacitance Code (pF)  | Packaging                  | Internal Use               | Capacitance Tolerance  |
| Polypropylene Film/Foil | E = 100<br>G = 160<br>I = 250<br>M = 400<br>P = 630<br>Q = 1000<br>R = 1250<br>T = 1600<br>U = 2000 | I = 15.0<br>N = 22.5<br>R = 27.5<br>W = 37.5 | The last three digits represent significant figures.<br>The first digit specifies the total number of zeros to be added. | See Ordering Options Table | 00<br>10<br>30<br>40<br>L0 | H = ±2.5% (for 2-section construction only)<br>J = ±5%<br>K = ±10% |

## Ordering Options Table

| Lead Spacing Nominal (mm) | Type of Leads and Packaging                | Lead Length (mm)     | Lead and Packaging Code |
|---------------------------|--|----------------------|-------------------------|
| 15<br><br>22.5            | <b>Standard Lead and Packaging Options</b> |                      |                         |
|                           | Bulk (Bag) – Short Leads                   | 4 +2/-0              | SE                      |
|                           | Ammo Pack                                  | $H_0 = 18.5 \pm 0.5$ | DQ                      |
|                           | <b>Other Lead and Packaging Options</b>    |                      |                         |
|                           | Tape & Reel (Standard Reel Ø 355 mm)       | $H_0 = 18.5 \pm 0.5$ | GY                      |
|                           | Tape & Reel (Large Reel Ø 500 mm)          | $H_0 = 18.5 \pm 0.5$ | CK                      |
|                           | Bulk (Bag) – Short Leads                   | 3.5 +0.5/-0          | JB                      |
|                           | Bulk (Bag) – Short Leads                   | 4.0 +0.5/-0          | JE                      |
|                           | Bulk (Bag) – Short Leads                   | 3.2 +0.3/-0.2        | JH                      |
|                           | Bulk (Bag) – Long Leads                    | 18 ±1                | JM                      |
| Bulk (Bag) – Long Leads   | 30 +5/-0                                   | 40                   |                         |
| Bulk (Bag) – Long Leads   | 25 +2/-1                                   | 50                   |                         |
| 27.5                      | <b>Standard Lead and Packaging Options</b> |                      |                         |
|                           | Bulk (Tray) – Short Leads                  | 4 +2/-0              | SE                      |
|                           | <b>Other Lead and Packaging Options</b>    |                      |                         |
|                           | Tape & Reel (Standard Reel Ø 355 mm)       | $H_0 = 18.5 \pm 0.5$ | GY                      |
|                           | Tape & Reel (Large Reel Ø 500 mm)          | $H_0 = 18.5 \pm 0.5$ | CK                      |
|                           | Bulk (Tray) – Short Leads                  | 3.5 +0.5/-0          | JB                      |
|                           | Bulk (Tray) – Short Leads                  | 4.0 +0.5/-0          | JE                      |
|                           | Bulk (Tray) – Short Leads                  | 3.2 +0.3/-0.2        | JH                      |
|                           | Bulk (Tray) – Long Leads                   | 18 ±1                | JM                      |
|                           | Bulk (Tray) – Long Leads                   | 30 +5/-0             | 40                      |
| Bulk (Tray) – Long Leads  | 25 +2/-1                                   | 50                   |                         |
| 37.5                      | <b>Standard Lead and Packaging Options</b> |                      |                         |
|                           | Bulk (Tray) – Short Leads                  | 4 +2/-0              | SE                      |
|                           | <b>Other Lead and Packaging Options</b>    |                      |                         |
|                           | Bulk (Tray) – Short Leads                  | 3.5 +0.5/-0          | JB                      |
|                           | Bulk (Tray) – Short Leads                  | 4.0 +0.5/-0          | JE                      |
|                           | Bulk (Tray) – Short Leads                  | 3.2 +0.3/-0.2        | JH                      |
|                           | Bulk (Tray) – Long Leads                   | 18 ±1                | JM                      |
|                           | Bulk (Tray) – Long Leads                   | 30 +5/-0             | 40                      |
| Bulk (Tray) – Long Leads  | 25 +2/-1                                   | 50                   |                         |

## Dimensions – Millimeters

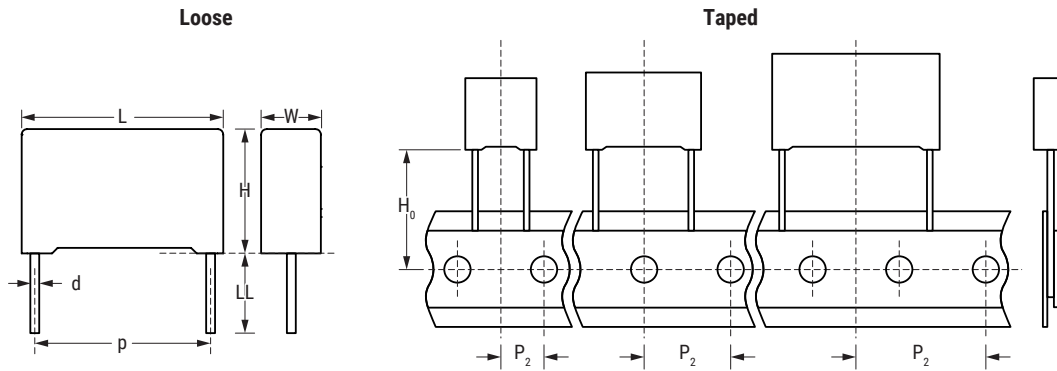

| p       |           | W       |           | H       |           | L       |           | d       |           |
|---------|-----------|---------|-----------|---------|-----------|---------|-----------|---------|-----------|
| Nominal | Tolerance | Nominal | Tolerance | Nominal | Tolerance | Nominal | Tolerance | Nominal | Tolerance |
| 15.0    | ±0.4      | 5.0     | +0.2      | 11.0    | +0.1      | 18.0    | +0.3      | 0.8     | ±0.05     |
| 15.0    | ±0.4      | 6.0     | +0.2      | 12.0    | +0.1      | 18.0    | +0.3      | 0.8     | ±0.05     |
| 15.0    | ±0.4      | 7.5     | +0.2      | 13.5    | +0.1      | 18.0    | +0.5      | 0.8     | ±0.05     |
| 15.0    | ±0.4      | 8.5     | +0.2      | 14.5    | +0.1      | 18.0    | +0.5      | 0.8     | ±0.05     |
| 15.0    | ±0.4      | 10.0    | +0.2      | 16.0    | +0.1      | 18.0    | +0.5      | 0.8     | ±0.05     |
| 22.5    | ±0.4      | 6.0     | +0.2      | 15.0    | +0.1      | 26.5    | +0.3      | 0.8     | ±0.05     |
| 22.5    | ±0.4      | 7.0     | +0.2      | 16.0    | +0.1      | 26.5    | +0.3      | 0.8     | ±0.05     |
| 22.5    | ±0.4      | 8.5     | +0.2      | 17.0    | +0.1      | 26.5    | +0.3      | 0.8     | ±0.05     |
| 22.5    | ±0.4      | 10.0    | +0.2      | 18.5    | +0.1      | 26.5    | +0.3      | 0.8     | ±0.05     |
| 22.5    | ±0.4      | 11.0    | +0.2      | 20.0    | +0.1      | 26.5    | +0.3      | 0.8     | ±0.05     |
| 27.5    | ±0.4      | 9.0     | +0.2      | 17.0    | +0.1      | 32.0    | +0.3      | 0.8     | ±0.05     |
| 27.5    | ±0.4      | 11.0    | +0.2      | 20.0    | +0.1      | 32.0    | +0.3      | 0.8     | ±0.05     |
| 27.5    | ±0.4      | 13.0    | +0.2      | 22.0    | +0.1      | 32.0    | +0.3      | 0.8     | ±0.05     |
| 27.5    | ±0.4      | 13.0    | +0.2      | 25.0    | +0.1      | 32.0    | +0.3      | 0.8     | ±0.05     |
| 27.5    | ±0.4      | 14.0    | +0.2      | 28.0    | +0.1      | 32.0    | +0.3      | 0.8     | ±0.05     |
| 27.5    | ±0.4      | 18.0    | +0.2      | 33.0    | +0.1      | 32.0    | +0.3      | 0.8     | ±0.05     |
| 27.5    | ±0.4      | 22.0    | +0.2      | 37.0    | +0.1      | 32.0    | +0.3      | 0.8     | ±0.05     |
| 27.5    | ±0.4      | 24.0    | +0.2      | 15.0    | +0.1      | 32.0    | +0.3      | 0.8     | ±0.05     |
| 37.5    | ±0.4      | 11.0    | +0.3      | 22.0    | +0.1      | 41.5    | +0.3      | 1.0     | ±0.05     |
| 37.5    | ±0.4      | 13.0    | +0.3      | 24.0    | +0.1      | 41.5    | +0.3      | 1.0     | ±0.05     |
| 37.5    | ±0.4      | 16.0    | +0.3      | 28.5    | +0.1      | 41.5    | +0.3      | 1.0     | ±0.05     |
| 37.5    | ±0.4      | 19.0    | +0.3      | 32.0    | +0.1      | 41.5    | +0.3      | 1.0     | ±0.05     |
| 37.5    | ±0.4      | 20.0    | +0.3      | 40.0    | +0.1      | 41.5    | +0.3      | 1.0     | ±0.05     |
| 37.5    | ±0.4      | 24.0    | +0.3      | 44.0    | +0.1      | 41.5    | +0.3      | 1.0     | ±0.05     |
| 37.5    | ±0.4      | 24.0    | +0.3      | 15.0    | +0.1      | 41.5    | +0.3      | 1.0     | ±0.05     |
| 37.5    | ±0.4      | 24.0    | +0.3      | 19.0    | +0.1      | 41.5    | +0.3      | 1.0     | ±0.05     |
| 37.5    | ±0.4      | 30.0    | +0.3      | 45.0    | +0.1      | 41.5    | +0.3      | 1.0     | ±0.05     |

**Note: See Ordering Options Table for lead length (LL/Ho) options.**

## Performance Characteristics

|                                     |  |             |               |              |            |              |               |              |               |
|-------------------------------------|--|-------------|---------------|--------------|------------|--------------|---------------|--------------|---------------|
| Dielectric                          | Polypropylene film   |             |               |              |            |              |               |              |               |
| Plates                              | Metal foil for 1 section, metal foil + metallized film for 2 sections  |             |               |              |            |              |               |              |               |
| Winding                             | Non-inductive type   |             |               |              |            |              |               |              |               |
| Leads                               | Tinned wire  |             |               |              |            |              |               |              |               |
| Protection                          | Plastic case, thermosetting resin filled. Box material is solvent resistant and flame retardant according to UL94. |             |               |              |            |              |               |              |               |
| Related Documents                   | IEC 60384-13   |             |               |              |            |              |               |              |               |
| Sections                            | 1  |             |               |              | 2          |              |               |              |               |
| Voltage Range (VDC)                 | 100  | 160         | 250           | 400          | 630        | 1,000        | 1,250         | 1,600        | 2,000         |
| Voltage Range (VAC)                 | 63   | 90          | 125           | 160          | 300        | 400          | 450           | 450          | 500           |
| Capacitance Range ( $\mu\text{F}$ ) | 0.047 – 0.15   | 0.033 – 0.1 | 0.015 – 0.047 | 0.01 – 0.047 | 0.01 – 2.2 | 0.0033 – 1.5 | 0.0022 – 0.82 | 0.001 – 0.56 | 0.0001 – 0.22 |
| Capacitance Values                  | E6/E12 series (IEC 60063) measured at 1kHz and +20 $\pm 1^\circ\text{C}$   |             |               |              |            |              |               |              |               |
| Capacitance Tolerance               | $\pm 5\%$ , $\pm 10\%$ , $\pm 2.5\%$ only for 2 sections   |             |               |              |            |              |               |              |               |
| Category Temperature Range          | -55 $^\circ\text{C}$ to +105 $^\circ\text{C}$  |             |               |              |            |              |               |              |               |
| Rated Temperature $T_R$             | +85 $^\circ\text{C}$   |             |               |              |            |              |               |              |               |
| Voltage Derating                    | Above +85 $^\circ\text{C}$ DC and AC voltage derating is 1.25%/ $^\circ\text{C}$                                   |             |               |              |            |              |               |              |               |
| Climatic Category                   | 55/105/56 IEC 60068-1  |             |               |              |            |              |               |              |               |

Maximum Humidity in Storage Conditions

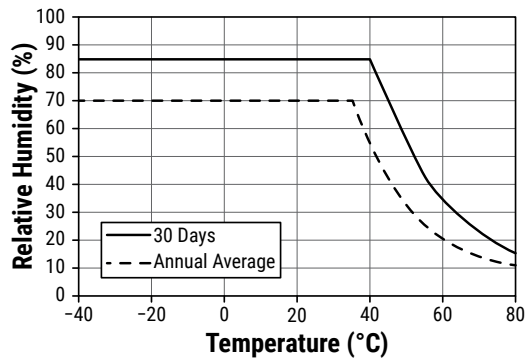

Maximum Overtemperature  $\Delta T_{lim}$  vs.  $T_h$

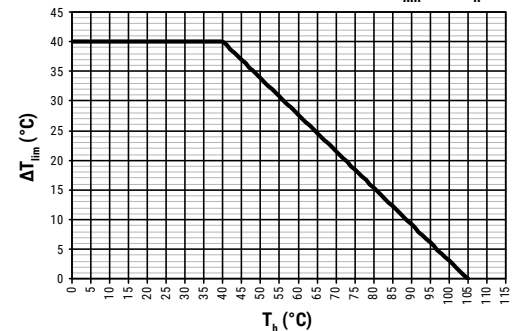

$T_h$  is the maximum ambient temperature surrounding the capacitor or hottest contact point (e.g. tracks), whichever is higher, in the worst operation conditions in  $^\circ\text{C}$ .

Maximum  $I_{rms}$  vs.  $T_h$

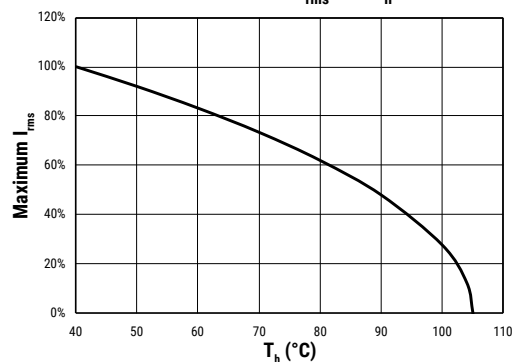

## Performance Characteristics cont.

|   |   |            |  |                   |      |
|---|---|------------|--|-------------------|------|
| Storage Conditions                      | Storage time: ≤ 24 months from the date marked on the label package   |            |  |                   |      |
|   | Average relative humidity per year ≤ 70%  |            |  |                   |      |
|   | RH ≤ 85% for 30 days randomly distributed throughout the year   |            |  |                   |      |
|   | Dew is absent   |            |  |                   |      |
|   | Temperature: -40 to 80°C (see "Maximum Humidity in Storage Conditions" graph above)   |            |  |                   |      |
| Test Voltage                            | 2.5 x V <sub>R</sub> VDC for 2s (between terminations) at +25°C ±5°C (1 section)<br>2 x V <sub>R</sub> VDC for 2s (between terminations) at +25°C ±5°C (2 sections)     |            |  |                   |      |
| Capacitance Drift                       | Maximum 0.5% after a 2 year storage period at a temperature of +10°C to +40°C and a relative humidity of 40% to 60%   |            |  |                   |      |
| Maximum Pulse Steepness                 | dV/dt according to Table 1. For working voltages lower than rated voltage (V < V <sub>R</sub> ), the specified dV/dt can be multiplied by the factor V <sub>R</sub> /V. |            |  |                   |      |
| Temperature Coefficient                 | -(150 ±70) ppm/°C at 1 kHz  |            |  |                   |      |
| Self Inductance<br>(Lead Length ~ 2 mm) | Lead Spacing (mm)   | 15         | 22.5                                     | 27.5              | 37.5 |
|   | L (nH) ≈  | 10         | 16                                       | 18                | 20   |
|   | Maximum 1 nH per 1 mm lead and capacitor length.  |            |  |                   |      |
| Dissipation Factor tanδ                 | Measured at 25°C ±5°C   |            |  |                   |      |
|   | Frequency   | C ≤ 0.1 μF |  | 0.1 μF < C ≤ 1 μF |      |
|   | 1 kHz   | 0.03%      |  | 0.03%             |      |
|   | 10 kHz  | 0.04%      |  | 0.06%             |      |
| 100 kHz                                 | 0.10%   |            | -  |                   |      |
| Insulation Resistance                   | Measured at +25°C, 100 VDC 60 seconds   |            |  |                   |      |
|   | Minimum Values Between Terminals  |            |  |                   |      |
|   | C ≤ 0.33 μF   |            | C > 0.33 μF                              |                   |      |
|   | ≥ 100,000 MΩ<br>(≥ 500,000 MΩ)*   |            | ≥ 30,000 MΩ · μF<br>(≥ 150,000 MΩ · μF)* |                   |      |

\* Typical value

## Qualification

Automotive Grade products meet or exceed the requirements outlined by the Automotive Electronics Council. Details regarding test methods and conditions are referenced in document AEC-Q200, Stress Test Qualification for Passive Components. For additional information regarding the Automotive Electronics Council and AEC-Q200, please visit their website at [www.aecouncil.com](http://www.aecouncil.com).

## Maximum Voltage ( $V_{rms}$ ) vs. Frequency (Sinusoidal Waveform/ $Th \leq 40^\circ C$ )

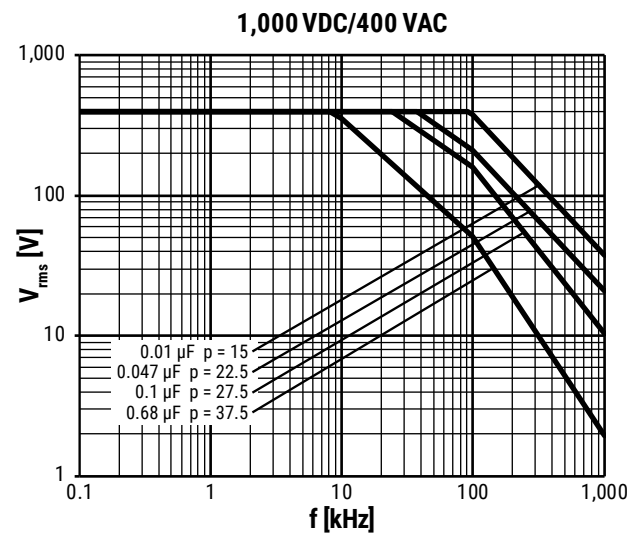
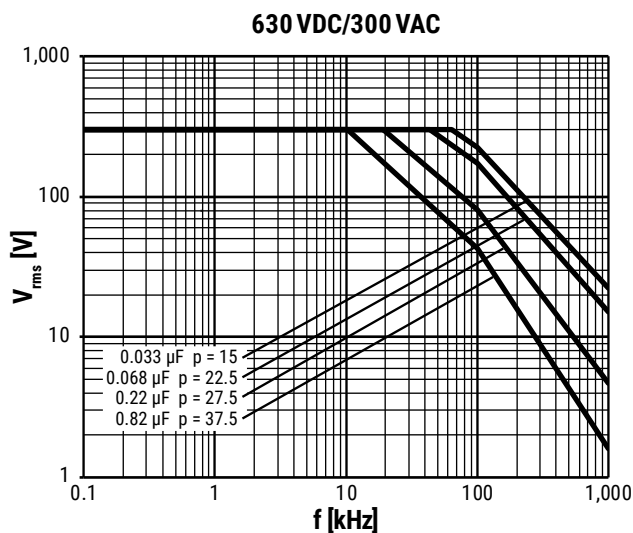
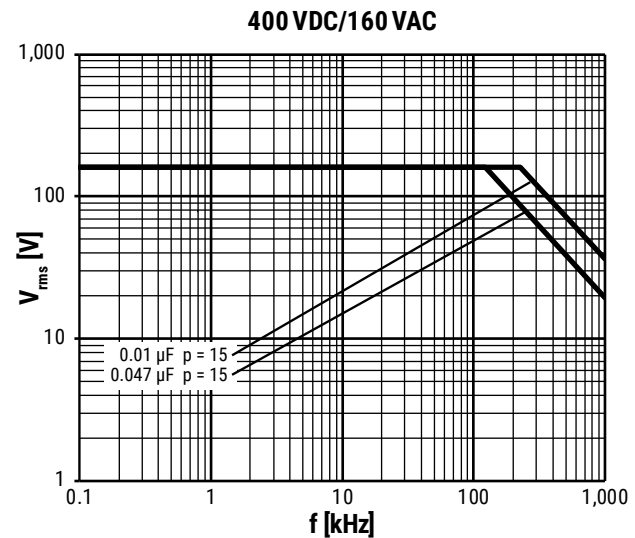
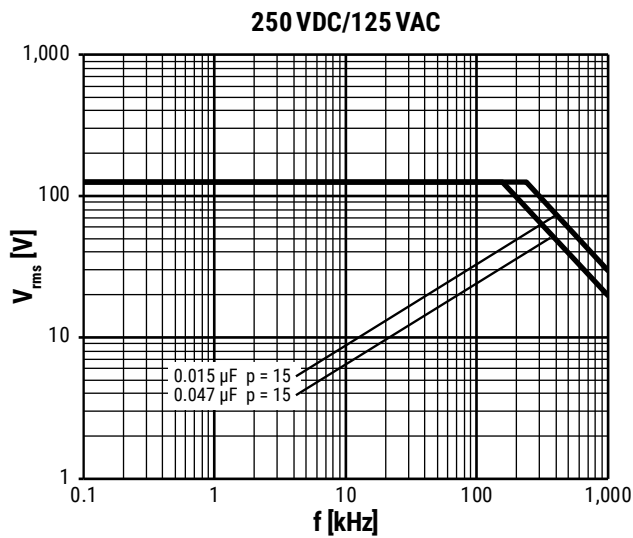
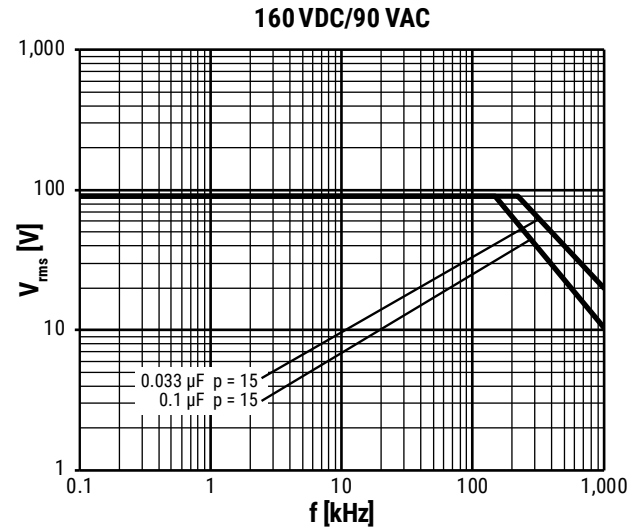
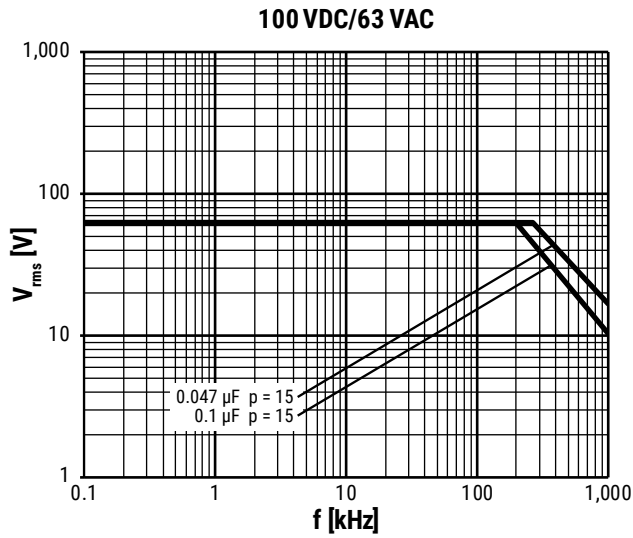

## Maximum Voltage ( $V_{rms}$ ) vs. Frequency (Sinusoidal Waveform/ $T_h \leq 40^\circ C$ ) cont.

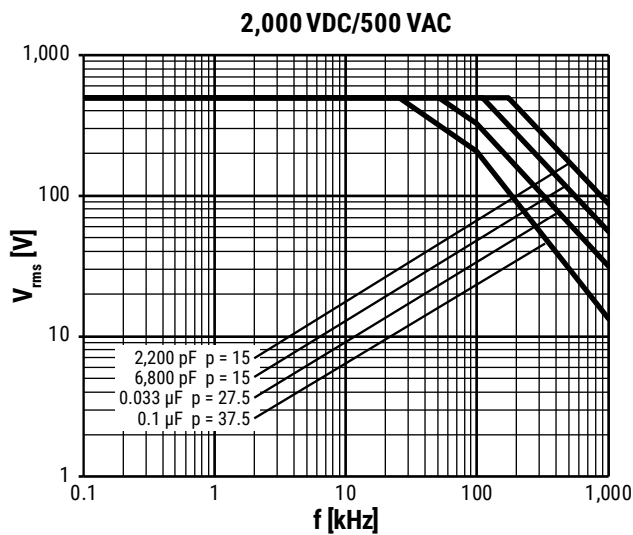
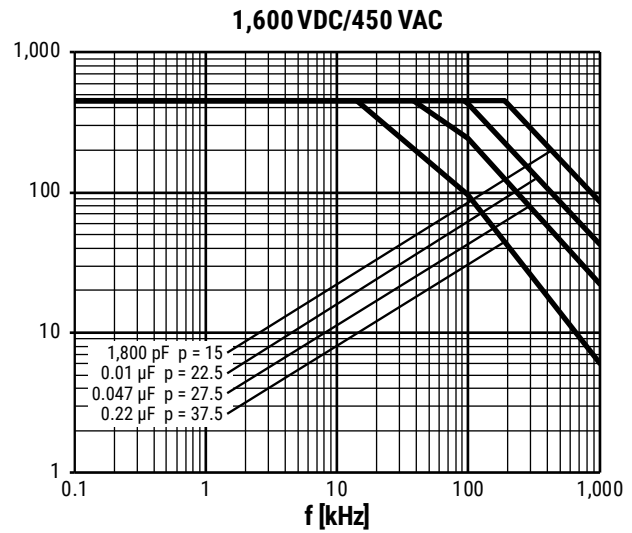
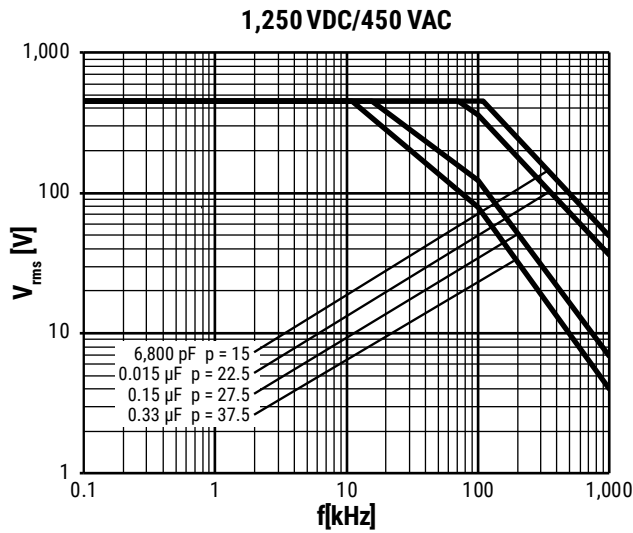

## Maximum Current ( $I_{rms}$ ) vs. Frequency (Sinusoidal Waveform/ $T_h \leq 40^\circ C$ )

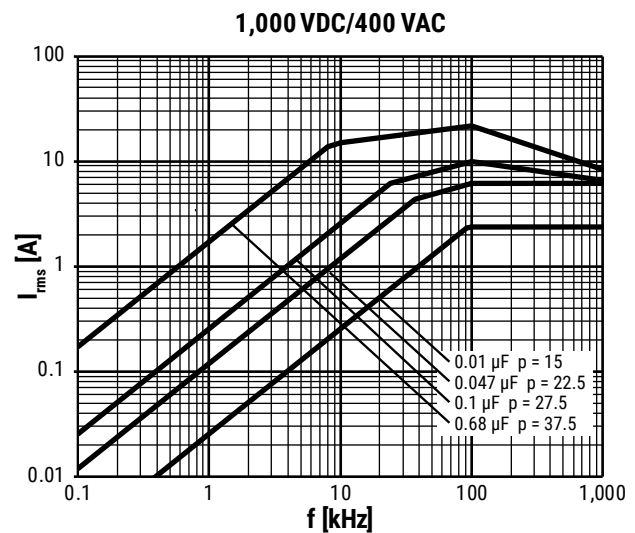
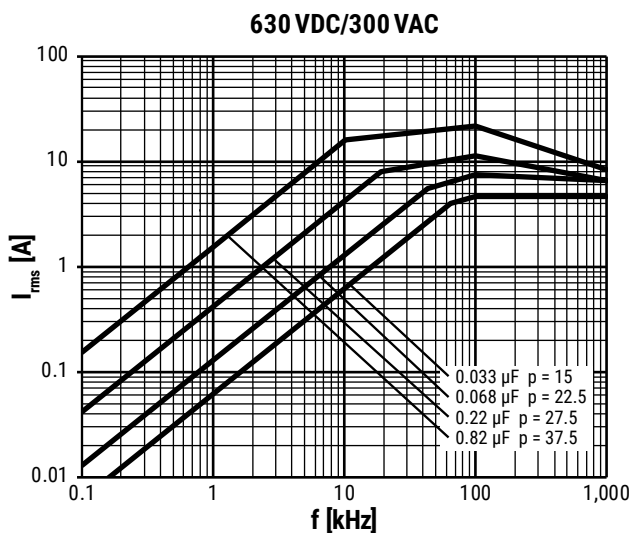
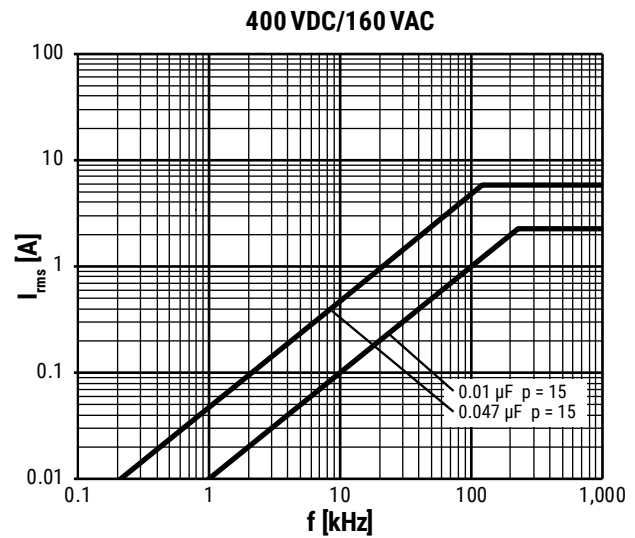
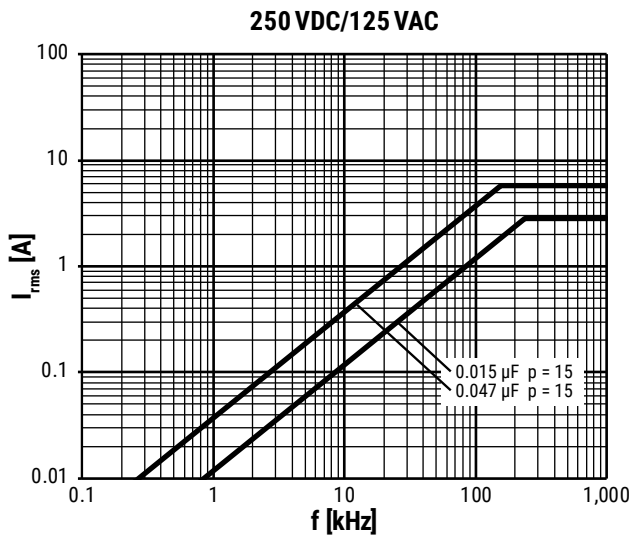
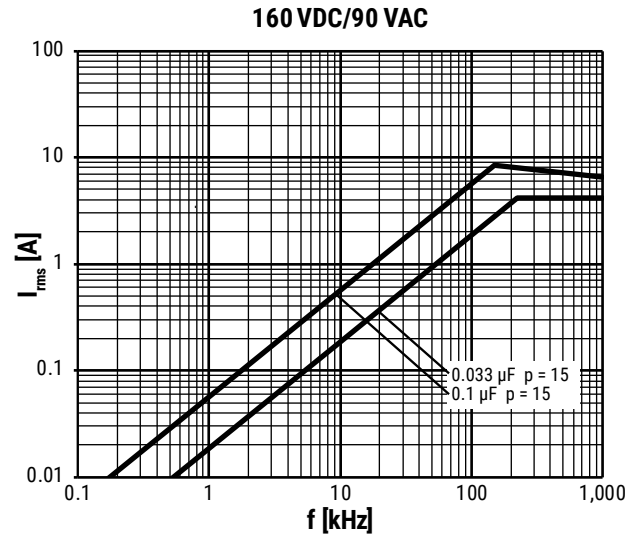
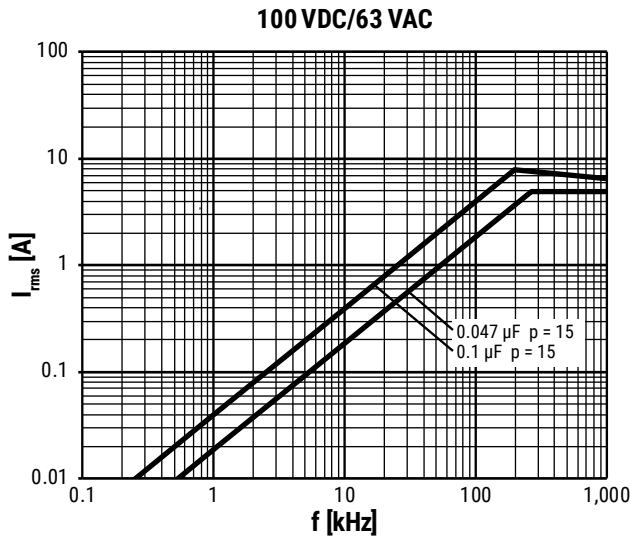



## Maximum Current ( $I_{rms}$ ) vs. Frequency (Sinusoidal Waveform/ $Th \leq 40^\circ C$ ) cont.

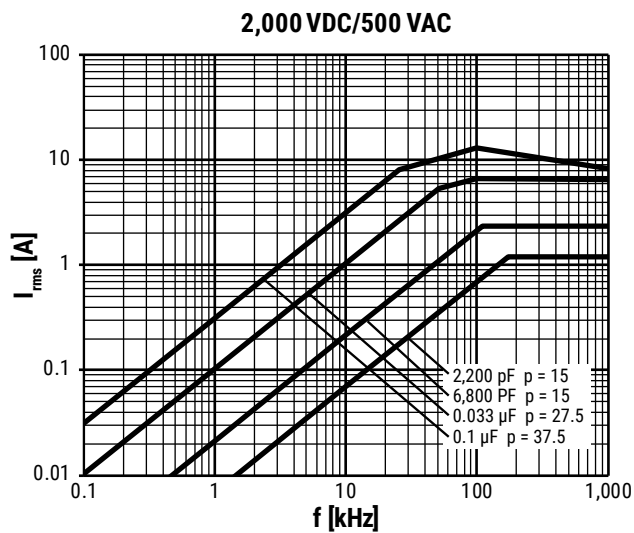
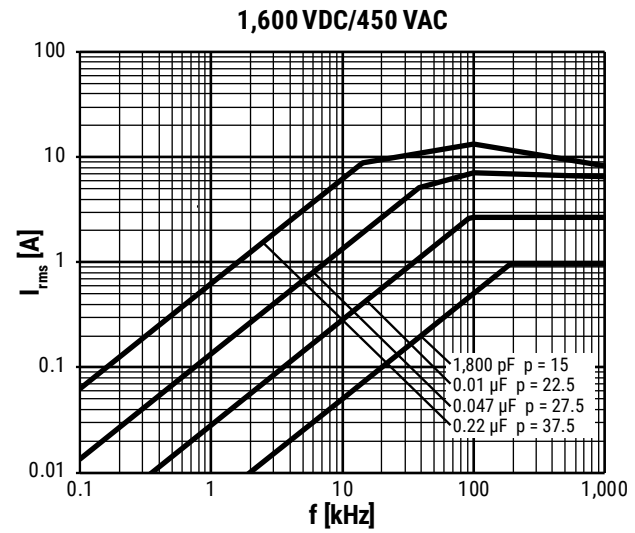
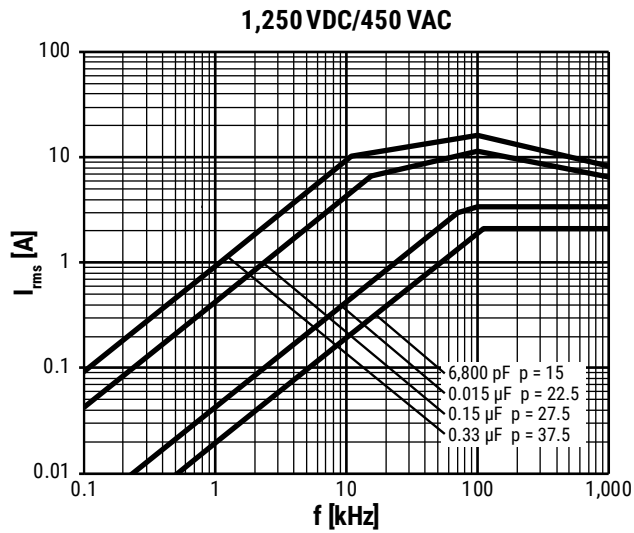

## Environmental Test Data

| Damp Heat, Steady State Test      | Test Conditions:   |  | Performances   |
|-----------------------------------|--|--|--|
|                                   | Temperature:<br>Relative humidity (RH):<br>Test duration:    | +40°C ±2°C<br>93% ±2%<br>56 days                       | Δ C/C  ≤ 2%,<br>Δ tanδ ≤ 0.0005 at 1 kHz<br>IR after test ≥ 50% of initial limit |
| Endurance Test                    | Test Conditions  |  | Performances   |
|                                   | Temperature:<br>Voltage applied:<br>Test duration:           | +85°C ±2°C<br>1.5 x V <sub>R</sub> (DC)<br>1,000 hours | Δ C/C  ≤ 2%,<br>Δ tanδ ≤ 0.0005 at 1 kHz<br>IR after test ≥ 50% of initial limit |
| Resistance to Soldering Heat Test | Test Conditions  |  | Performances   |
|                                   | Solder bath temperature:<br>Dipping time (with heat screen): | 260°C ±5°C<br>10 seconds ±1 second                     | Δ C/C  ≤ 1%,<br>Δ tanδ ≤ 0.003 at 1 kHz<br>IR after test ≥ initial limit         |

## Environmental Compliance

All KEMET pulse capacitors are RoHS Compliant.

**Table 1 – Ratings & Part Number Reference**

| VDC | VAC | Capacitance Value (μF) | Dimensions in mm |        |        | Lead Spacing (p) | dV/dt (V/μs) | Max K <sub>0</sub> (V <sup>2</sup> /μs) | KEMET Internal Part Number | Customer Part Number |
|-----|-----|------------------------|------------------|--------|--------|------------------|--------------|---|----------------------------|----------------------|
|     |     |                        | B                | H      | L      |                  |              |   |                            |                      |
| 100 | 63  | 0.047                  | 5.0              | 11.0   | 18.0   | 15.0             | 2,400        | 480,000                                 | 73EI2470(1)00(2)           | R73EI2470(1)00(2)    |
| 100 | 63  | 0.068                  | 6.0              | 12.0   | 18.0   | 15.0             | 2,400        | 480,000                                 | 73EI2680(1)00(2)           | R73EI2680(1)00(2)    |
| 100 | 63  | 0.10                   | 7.5              | 13.5   | 18.0   | 15.0             | 2,400        | 480,000                                 | 73EI3100(1)00(2)           | R73EI3100(1)00(2)    |
| 100 | 63  | 0.15                   | 10.0             | 16.0   | 18.0   | 15.0             | 2,400        | 480,000                                 | 73EI3150(1)00(2)           | R73EI3150(1)00(2)    |
| 160 | 90  | 0.033                  | 5.0              | 11.0   | 18.0   | 15.0             | 3,000        | 960,000                                 | 73GI2330(1)00(2)           | R73GI2330(1)00(2)    |
| 160 | 90  | 0.047                  | 6.0              | 12.0   | 18.0   | 15.0             | 3,000        | 960,000                                 | 73GI2470(1)00(2)           | R73GI2470(1)00(2)    |
| 160 | 90  | 0.068                  | 7.5              | 13.5   | 18.0   | 15.0             | 3,000        | 960,000                                 | 73GI2680(1)00(2)           | R73GI2680(1)00(2)    |
| 160 | 90  | 0.10                   | 10.0             | 16.0   | 18.0   | 15.0             | 3,000        | 960,000                                 | 73GI3100(1)00(2)           | R73GI3100(1)00(2)    |
| 250 | 125 | 0.015                  | 5.0              | 11.0   | 18.0   | 15.0             | 4,800        | 2,400,000                               | 73II2150(1)00(2)           | R73II2150(1)00(2)    |
| 250 | 125 | 0.022                  | 6.0              | 12.0   | 18.0   | 15.0             | 4,800        | 2,400,000                               | 73II2220(1)00(2)           | R73II2220(1)00(2)    |
| 250 | 125 | 0.033                  | 7.5              | 13.5   | 18.0   | 15.0             | 4,800        | 2,400,000                               | 73II2330(1)00(2)           | R73II2330(1)00(2)    |
| 250 | 125 | 0.047                  | 10.0             | 16.0   | 18.0   | 15.0             | 4,800        | 2,400,000                               | 73II2470(1)00(2)           | R73II2470(1)00(2)    |
| 400 | 160 | 0.010                  | 5.0              | 11.0   | 18.0   | 15.0             | 6,000        | 4,800,000                               | 73MI2100(1)00(2)           | R73MI2100(1)00(2)    |
| 400 | 160 | 0.015                  | 6.0              | 12.0   | 18.0   | 15.0             | 6,000        | 4,800,000                               | 73MI2150(1)00(2)           | R73MI2150(1)00(2)    |
| 400 | 160 | 0.022                  | 7.5              | 13.5   | 18.0   | 15.0             | 6,000        | 4,800,000                               | 73MI2220(1)00(2)           | R73MI2220(1)00(2)    |
| 400 | 160 | 0.033                  | 8.5              | 14.5   | 18.0   | 15.0             | 6,000        | 4,800,000                               | 73MI2330(1)00(2)           | R73MI2330(1)00(2)    |
| 400 | 160 | 0.047                  | 10.0             | 16.0   | 18.0   | 15.0             | 6,000        | 4,800,000                               | 73MI2470(1)00(2)           | R73MI2470(1)00(2)    |
| 630 | 300 | 0.010                  | 5.0              | 11.0   | 18.0   | 15.0             | 11,000       | 13,860,000                              | 73PI2100(1)00(2)           | R73PI2100(1)00(2)    |
| 630 | 300 | 0.012                  | 5.0              | 11.0   | 18.0   | 15.0             | 11,000       | 13,860,000                              | 73PI2120(1)00(2)           | R73PI2120(1)00(2)    |
| 630 | 300 | 0.015                  | 6.0              | 12.0   | 18.0   | 15.0             | 11,000       | 13,860,000                              | 73PI2150(1)00(2)           | R73PI2150(1)00(2)    |
| 630 | 300 | 0.018                  | 6.0              | 12.0   | 18.0   | 15.0             | 11,000       | 13,860,000                              | 73PI2180(1)00(2)           | R73PI2180(1)00(2)    |
| 630 | 300 | 0.022                  | 7.5              | 13.5   | 18.0   | 15.0             | 11,000       | 13,860,000                              | 73PI2220(1)00(2)           | R73PI2220(1)00(2)    |
| 630 | 300 | 0.027                  | 7.5              | 13.5   | 18.0   | 15.0             | 11,000       | 13,860,000                              | 73PI2270(1)00(2)           | R73PI2270(1)00(2)    |
| 630 | 300 | 0.033                  | 8.5              | 14.5   | 18.0   | 15.0             | 11,000       | 13,860,000                              | 73PI2330(1)00(2)           | R73PI2330(1)00(2)    |
| VDC | VAC | Capacitance Value (μF) | B (mm)           | H (mm) | L (mm) | Lead Spacing (p) | dV/dt (V/μs) | Max K <sub>0</sub> (V <sup>2</sup> /μs) | KEMET Internal Part Number | Customer Part Number |

(1) Insert lead and packaging code. See Ordering Options Table for available options.

(2) J = 5%, K = 10%

**Table 1 – Ratings & Part Number Reference cont.**

| VDC   | VAC | Capacitance Value (µF) | Dimensions in mm |        |        | Lead Spacing (p) | dV/dt (V/µs) | Max K <sub>0</sub> (V <sup>2</sup> /µs) | KEMET Internal Part Number | Customer Part Number |
|-------|-----|------------------------|------------------|--------|--------|------------------|--------------|---|----------------------------|----------------------|
|       |     |                        | B                | H      | L      |                  |              |   |                            |                      |
| 630   | 300 | 0.039                  | 10.0             | 16.0   | 18.0   | 15.0             | 11,000       | 13,860,000                              | 73PI2390(1)00(2)           | R73PI2390(1)00(2)    |
| 630   | 300 | 0.047                  | 10.0             | 16.0   | 18.0   | 15.0             | 11,000       | 13,860,000                              | 73PI2470(1)00(2)           | R73PI2470(1)00(2)    |
| 630   | 300 | 0.039                  | 6.0              | 15.0   | 26.5   | 22.5             | 11,000       | 13,860,000                              | 73PN2390(1)00(2)           | R73PN2390(1)00(2)    |
| 630   | 300 | 0.047                  | 7.0              | 16.0   | 26.5   | 22.5             | 11,000       | 13,860,000                              | 73PN2470(1)00(2)           | R73PN2470(1)00(2)    |
| 630   | 300 | 0.056                  | 7.0              | 16.0   | 26.5   | 22.5             | 11,000       | 13,860,000                              | 73PN2560(1)00(2)           | R73PN2560(1)00(2)    |
| 630   | 300 | 0.068                  | 8.5              | 17.0   | 26.5   | 22.5             | 11,000       | 13,860,000                              | 73PN2680(1)00(2)           | R73PN2680(1)00(2)    |
| 630   | 300 | 0.082                  | 10.0             | 18.5   | 26.5   | 22.5             | 11,000       | 13,860,000                              | 73PN2820(1)00(2)           | R73PN2820(1)00(2)    |
| 630   | 300 | 0.10                   | 10.0             | 18.5   | 26.5   | 22.5             | 11,000       | 13,860,000                              | 73PN3100(1)00(2)           | R73PN3100(1)00(2)    |
| 630   | 300 | 0.10                   | 9.0              | 17.0   | 32.0   | 27.5             | 11,000       | 13,860,000                              | 73PR3100(1)00(2)           | R73PR3100(1)00(2)    |
| 630   | 300 | 0.12                   | 9.0              | 17.0   | 32.0   | 27.5             | 11,000       | 13,860,000                              | 73PR3120(1)00(2)           | R73PR3120(1)00(2)    |
| 630   | 300 | 0.15                   | 11.0             | 20.0   | 32.0   | 27.5             | 11,000       | 13,860,000                              | 73PR3150(1)00(2)           | R73PR3150(1)00(2)    |
| 630   | 300 | 0.18                   | 11.0             | 20.0   | 32.0   | 27.5             | 11,000       | 13,860,000                              | 73PR3180(1)10(2)           | R73PR3180(1)10(2)    |
| 630   | 300 | 0.18                   | 13.0             | 22.0   | 32.0   | 27.5             | 11,000       | 13,860,000                              | 73PR3180(1)00(2)           | R73PR3180(1)00(2)    |
| 630   | 300 | 0.18                   | 24.0             | 15.0   | 32.0   | 27.5             | 11,000       | 13,860,000                              | 73PR3180(1)L0(2)           | R73PR3180(1)L0(2)    |
| 630   | 300 | 0.22                   | 13.0             | 22.0   | 32.0   | 27.5             | 11,000       | 13,860,000                              | 73PR3220(1)00(2)           | R73PR3220(1)00(2)    |
| 630   | 300 | 0.22                   | 24.0             | 15.0   | 32.0   | 27.5             | 11,000       | 13,860,000                              | 73PR3220(1)L0(2)           | R73PR3220(1)L0(2)    |
| 630   | 300 | 0.27                   | 13.0             | 25.0   | 32.0   | 27.5             | 11,000       | 13,860,000                              | 73PR3270(1)10(2)           | R73PR3270(1)10(2)    |
| 630   | 300 | 0.27                   | 24.0             | 15.0   | 32.0   | 27.5             | 11,000       | 13,860,000                              | 73PR3270(1)L0(2)           | R73PR3270(1)L0(2)    |
| 630   | 300 | 0.33                   | 14.0             | 28.0   | 32.0   | 27.5             | 11,000       | 13,860,000                              | 73PR3330(1)00(2)           | R73PR3330(1)00(2)    |
| 630   | 300 | 0.33                   | 24.0             | 15.0   | 32.0   | 27.5             | 11,000       | 13,860,000                              | 73PR3330(1)L0(2)           | R73PR3330(1)L0(2)    |
| 630   | 300 | 0.39                   | 14.0             | 28.0   | 32.0   | 27.5             | 11,000       | 13,860,000                              | 73PR3390(1)10(2)           | R73PR3390(1)10(2)    |
| 630   | 300 | 0.39                   | 18.0             | 33.0   | 32.0   | 27.5             | 11,000       | 13,860,000                              | 73PR3390(1)00(2)           | R73PR3390(1)00(2)    |
| 630   | 300 | 0.47                   | 18.0             | 33.0   | 32.0   | 27.5             | 11,000       | 13,860,000                              | 73PR3470(1)00(2)           | R73PR3470(1)00(2)    |
| 630   | 300 | 0.56                   | 18.0             | 33.0   | 32.0   | 27.5             | 11,000       | 13,860,000                              | 73PR3560(1)10(2)           | R73PR3560(1)10(2)    |
| 630   | 300 | 0.56                   | 22.0             | 37.0   | 32.0   | 27.5             | 11,000       | 13,860,000                              | 73PR3560(1)00(2)           | R73PR3560(1)00(2)    |
| 630   | 300 | 0.68                   | 22.0             | 37.0   | 32.0   | 27.5             | 11,000       | 13,860,000                              | 73PR3680(1)00(2)           | R73PR3680(1)00(2)    |
| 630   | 300 | 0.82                   | 22.0             | 37.0   | 32.0   | 27.5             | 11,000       | 13,860,000                              | 73PR3820(1)10(2)           | R73PR3820(1)10(2)    |
| 630   | 300 | 0.22                   | 11.0             | 22.0   | 41.5   | 37.5             | 3,000        | 3,780,000                               | 73PW3220(1)00(2)           | R73PW3220(1)00(2)    |
| 630   | 300 | 0.27                   | 11.0             | 22.0   | 41.5   | 37.5             | 3,000        | 3,780,000                               | 73PW3270(1)00(2)           | R73PW3270(1)00(2)    |
| 630   | 300 | 0.27                   | 24.0             | 15.0   | 41.5   | 37.5             | 3,000        | 3,780,000                               | 73PW3270(1)L0(2)           | R73PW3270(1)L0(2)    |
| 630   | 300 | 0.33                   | 11.0             | 22.0   | 41.5   | 37.5             | 3,000        | 3,780,000                               | 73PW3330(1)10(2)           | R73PW3330(1)10(2)    |
| 630   | 300 | 0.33                   | 13.0             | 24.0   | 41.5   | 37.5             | 3,000        | 3,780,000                               | 73PW3330(1)00(2)           | R73PW3330(1)00(2)    |
| 630   | 300 | 0.33                   | 24.0             | 15.0   | 41.5   | 37.5             | 3,000        | 3,780,000                               | 73PW3330(1)L0(2)           | R73PW3330(1)L0(2)    |
| 630   | 300 | 0.39                   | 13.0             | 24.0   | 41.5   | 37.5             | 3,000        | 3,780,000                               | 73PW3390(1)00(2)           | R73PW3390(1)00(2)    |
| 630   | 300 | 0.39                   | 24.0             | 15.0   | 41.5   | 37.5             | 3,000        | 3,780,000                               | 73PW3390(1)L0(2)           | R73PW3390(1)L0(2)    |
| 630   | 300 | 0.47                   | 13.0             | 24.0   | 41.5   | 37.5             | 3,000        | 3,780,000                               | 73PW3470(1)10(2)           | R73PW3470(1)10(2)    |
| 630   | 300 | 0.47                   | 16.0             | 28.5   | 41.5   | 37.5             | 3,000        | 3,780,000                               | 73PW3470(1)00(2)           | R73PW3470(1)00(2)    |
| 630   | 300 | 0.47                   | 24.0             | 15.0   | 41.5   | 37.5             | 3,000        | 3,780,000                               | 73PW3470(1)L0(2)           | R73PW3470(1)L0(2)    |
| 630   | 300 | 0.56                   | 16.0             | 28.5   | 41.5   | 37.5             | 3,000        | 3,780,000                               | 73PW3560(1)00(2)           | R73PW3560(1)00(2)    |
| 630   | 300 | 0.56                   | 24.0             | 19.0   | 41.5   | 37.5             | 3,000        | 3,780,000                               | 73PW3560(1)L0(2)           | R73PW3560(1)L0(2)    |
| 630   | 300 | 0.68                   | 16.0             | 28.5   | 41.5   | 37.5             | 3,000        | 3,780,000                               | 73PW3680(1)00(2)           | R73PW3680(1)00(2)    |
| 630   | 300 | 0.68                   | 24.0             | 19.0   | 41.5   | 37.5             | 3,000        | 3,780,000                               | 73PW3680(1)L0(2)           | R73PW3680(1)L0(2)    |
| 630   | 300 | 0.82                   | 19.0             | 32.0   | 41.5   | 37.5             | 3,000        | 3,780,000                               | 73PW3820(1)00(2)           | R73PW3820(1)00(2)    |
| 630   | 300 | 1.0                    | 20.0             | 40.0   | 41.5   | 37.5             | 3,000        | 3,780,000                               | 73PW4100(1)00(2)           | R73PW4100(1)00(2)    |
| 630   | 300 | 1.2                    | 20.0             | 40.0   | 41.5   | 37.5             | 3,000        | 3,780,000                               | 73PW4120(1)00(2)           | R73PW4120(1)00(2)    |
| 630   | 300 | 1.5                    | 24.0             | 44.0   | 41.5   | 37.5             | 3,000        | 3,780,000                               | 73PW4150(1)00(2)           | R73PW4150(1)00(2)    |
| 630   | 300 | 1.8                    | 30.0             | 45.0   | 41.5   | 37.5             | 3,000        | 3,780,000                               | 73PW4180(1)00(2)           | R73PW4180(1)00(2)    |
| 630   | 300 | 2.2                    | 30.0             | 45.0   | 41.5   | 37.5             | 3,000        | 3,780,000                               | 73PW4220(1)00(2)           | R73PW4220(1)00(2)    |
| 1,000 | 400 | 0.0033                 | 5.0              | 11.0   | 18.0   | 15.0             | 28,000       | 56,000,000                              | 73QI1330(1)30(2)           | R73QI1330(1)30(2)    |
| 1,000 | 400 | 0.0039                 | 5.0              | 11.0   | 18.0   | 15.0             | 28,000       | 56,000,000                              | 73QI1390(1)30(2)           | R73QI1390(1)30(2)    |
| 1,000 | 400 | 0.0047                 | 5.0              | 11.0   | 18.0   | 15.0             | 28,000       | 56,000,000                              | 73QI1470(1)30(2)           | R73QI1470(1)30(2)    |
| 1,000 | 400 | 0.0056                 | 5.0              | 11.0   | 18.0   | 15.0             | 28,000       | 56,000,000                              | 73QI1560(1)30(2)           | R73QI1560(1)30(2)    |
| 1,000 | 400 | 0.0068                 | 5.0              | 11.0   | 18.0   | 15.0             | 28,000       | 56,000,000                              | 73QI1680(1)30(2)           | R73QI1680(1)30(2)    |
| 1,000 | 400 | 0.0082                 | 5.0              | 11.0   | 18.0   | 15.0             | 28,000       | 56,000,000                              | 73QI1820(1)30(2)           | R73QI1820(1)30(2)    |
| 1,000 | 400 | 0.010                  | 6.0              | 12.0   | 18.0   | 15.0             | 28,000       | 56,000,000                              | 73QI2100(1)30(2)           | R73QI2100(1)30(2)    |
| 1,000 | 400 | 0.012                  | 6.0              | 12.0   | 18.0   | 15.0             | 28,000       | 56,000,000                              | 73QI2120(1)30(2)           | R73QI2120(1)30(2)    |
| 1,000 | 400 | 0.015                  | 7.5              | 13.5   | 18.0   | 15.0             | 28,000       | 56,000,000                              | 73QI2150(1)30(2)           | R73QI2150(1)30(2)    |
| 1,000 | 400 | 0.018                  | 8.5              | 14.5   | 18.0   | 15.0             | 28,000       | 56,000,000                              | 73QI2180(1)30(2)           | R73QI2180(1)30(2)    |
| 1,000 | 400 | 0.022                  | 8.5              | 14.5   | 18.0   | 15.0             | 28,000       | 56,000,000                              | 73QI2220(1)30(2)           | R73QI2220(1)30(2)    |
| VDC   | VAC | Capacitance Value (µF) | B (mm)           | H (mm) | L (mm) | Lead Spacing (p) | dV/dt (V/µs) | Max K <sub>0</sub> (V <sup>2</sup> /µs) | KEMET Internal Part Number | Customer Part Number |

(1) Insert lead and packaging code. See Ordering Options Table for available options.

(2) J = 5%, K = 10%

**Table 1 – Ratings & Part Number Reference cont.**

| VDC   | VAC | Capacitance Value (µF) | Dimensions in mm |        |        | Lead Spacing (p) | dV/dt (V/µs) | Max K <sub>0</sub> (V <sup>2</sup> /µs) | KEMET Internal Part Number | Customer Part Number |
|-------|-----|------------------------|------------------|--------|--------|------------------|--------------|---|----------------------------|----------------------|
|       |     |                        | B                | H      | L      |                  |              |   |                            |                      |
| 1,000 | 400 | 0.027                  | 10.0             | 16.0   | 18.0   | 15.0             | 28,000       | 56,000,000                              | 73QI2270(1)30(2)           | R73QI2270(1)30(2)    |
| 1,000 | 400 | 0.015                  | 6.0              | 15.0   | 26.5   | 22.5             | 11,000       | 22,000,000                              | 73QN2150(1)30(2)           | R73QN2150(1)30(2)    |
| 1,000 | 400 | 0.018                  | 6.0              | 15.0   | 26.5   | 22.5             | 11,000       | 22,000,000                              | 73QN2180(1)30(2)           | R73QN2180(1)30(2)    |
| 1,000 | 400 | 0.022                  | 6.0              | 15.0   | 26.5   | 22.5             | 11,000       | 22,000,000                              | 73QN2220(1)30(2)           | R73QN2220(1)30(2)    |
| 1,000 | 400 | 0.027                  | 7.0              | 16.0   | 26.5   | 22.5             | 11,000       | 22,000,000                              | 73QN2270(1)30(2)           | R73QN2270(1)30(2)    |
| 1,000 | 400 | 0.033                  | 7.0              | 16.0   | 26.5   | 22.5             | 11,000       | 22,000,000                              | 73QN2330(1)30(2)           | R73QN2330(1)30(2)    |
| 1,000 | 400 | 0.039                  | 8.5              | 17.0   | 26.5   | 22.5             | 11,000       | 22,000,000                              | 73QN2390(1)30(2)           | R73QN2390(1)30(2)    |
| 1,000 | 400 | 0.047                  | 10.0             | 18.5   | 26.5   | 22.5             | 11,000       | 22,000,000                              | 73QN2470(1)30(2)           | R73QN2470(1)30(2)    |
| 1,000 | 400 | 0.056                  | 10.0             | 18.5   | 26.5   | 22.5             | 11,000       | 22,000,000                              | 73QN2560(1)30(2)           | R73QN2560(1)30(2)    |
| 1,000 | 400 | 0.068                  | 11.0             | 20.0   | 26.5   | 22.5             | 11,000       | 22,000,000                              | 73QN2680(1)30(2)           | R73QN2680(1)30(2)    |
| 1,000 | 400 | 0.047                  | 9.0              | 17.0   | 32.0   | 27.5             | 11,000       | 22,000,000                              | 73QR2470(1)30(2)           | R73QR2470(1)30(2)    |
| 1,000 | 400 | 0.056                  | 9.0              | 17.0   | 32.0   | 27.5             | 11,000       | 22,000,000                              | 73QR2560(1)30(2)           | R73QR2560(1)30(2)    |
| 1,000 | 400 | 0.068                  | 9.0              | 17.0   | 32.0   | 27.5             | 11,000       | 22,000,000                              | 73QR2680(1)30(2)           | R73QR2680(1)30(2)    |
| 1,000 | 400 | 0.082                  | 9.0              | 17.0   | 32.0   | 27.5             | 11,000       | 22,000,000                              | 73QR2820(1)40(2)           | R73QR2820(1)40(2)    |
| 1,000 | 400 | 0.082                  | 11.0             | 20.0   | 32.0   | 27.5             | 11,000       | 22,000,000                              | 73QR2820(1)30(2)           | R73QR2820(1)30(2)    |
| 1,000 | 400 | 0.10                   | 11.0             | 20.0   | 32.0   | 27.5             | 11,000       | 22,000,000                              | 73QR3100(1)30(2)           | R73QR3100(1)30(2)    |
| 1,000 | 400 | 0.10                   | 24.0             | 15.0   | 32.0   | 27.5             | 11,000       | 22,000,000                              | 73QR3100(1)L0(2)           | R73QR3100(1)L0(2)    |
| 1,000 | 400 | 0.12                   | 11.0             | 20.0   | 32.0   | 27.5             | 11,000       | 22,000,000                              | 73QR3120(1)40(2)           | R73QR3120(1)40(2)    |
| 1,000 | 400 | 0.12                   | 13.0             | 22.0   | 32.0   | 27.5             | 11,000       | 22,000,000                              | 73QR3120(1)30(2)           | R73QR3120(1)30(2)    |
| 1,000 | 400 | 0.12                   | 24.0             | 15.0   | 32.0   | 27.5             | 11,000       | 22,000,000                              | 73QR3120(1)L0(2)           | R73QR3120(1)L0(2)    |
| 1,000 | 400 | 0.15                   | 13.0             | 22.0   | 32.0   | 27.5             | 11,000       | 22,000,000                              | 73QR3150(1)30(2)           | R73QR3150(1)30(2)    |
| 1,000 | 400 | 0.15                   | 25.0             | 15.0   | 32.0   | 27.5             | 11,000       | 22,000,000                              | 73QR3150(1)L0(2)           | R73QR3150(1)L0(2)    |
| 1,000 | 400 | 0.18                   | 13.0             | 25.0   | 32.0   | 27.5             | 11,000       | 22,000,000                              | 73QR3180(1)40(2)           | R73QR3180(1)40(2)    |
| 1,000 | 400 | 0.18                   | 24.0             | 15.0   | 32.0   | 27.5             | 11,000       | 22,000,000                              | 73QR3180(1)L0(2)           | R73QR3180(1)L0(2)    |
| 1,000 | 400 | 0.22                   | 14.0             | 28.0   | 32.0   | 27.5             | 11,000       | 22,000,000                              | 73QR3220(1)30(2)           | R73QR3220(1)30(2)    |
| 1,000 | 400 | 0.27                   | 18.0             | 33.0   | 32.0   | 27.5             | 11,000       | 22,000,000                              | 73QR3270(1)30(2)           | R73QR3270(1)30(2)    |
| 1,000 | 400 | 0.33                   | 18.0             | 33.0   | 32.0   | 27.5             | 11,000       | 22,000,000                              | 73QR3330(1)30(2)           | R73QR3330(1)30(2)    |
| 1,000 | 400 | 0.47                   | 22.0             | 37.0   | 32.0   | 27.5             | 11,000       | 22,000,000                              | 73QR3470(1)30(2)           | R73QR3470(1)30(2)    |
| 1,000 | 400 | 0.12                   | 11.0             | 22.0   | 41.5   | 37.5             | 4,500        | 9,000,000                               | 73QW3120(1)30(2)           | R73QW3120(1)30(2)    |
| 1,000 | 400 | 0.15                   | 11.0             | 22.0   | 41.5   | 37.5             | 4,500        | 9,000,000                               | 73QW3150(1)30(2)           | R73QW3150(1)30(2)    |
| 1,000 | 400 | 0.15                   | 24.0             | 15.0   | 41.5   | 37.5             | 4,500        | 9,000,000                               | 73QW3150(1)L0(2)           | R73QW3150(1)L0(2)    |
| 1,000 | 400 | 0.18                   | 11.0             | 22.0   | 41.5   | 37.5             | 4,500        | 9,000,000                               | 73QW3180(1)30(2)           | R73QW3180(1)30(2)    |
| 1,000 | 400 | 0.18                   | 24.0             | 15.0   | 41.5   | 37.5             | 4,500        | 9,000,000                               | 73QW3180(1)L0(2)           | R73QW3180(1)L0(2)    |
| 1,000 | 400 | 0.22                   | 13.0             | 24.0   | 41.5   | 37.5             | 4,500        | 9,000,000                               | 73QW3220(1)30(2)           | R73QW3220(1)30(2)    |
| 1,000 | 400 | 0.22                   | 24.0             | 15.0   | 41.5   | 37.5             | 4,500        | 9,000,000                               | 73QW3220(1)L0(2)           | R73QW3220(1)L0(2)    |
| 1,000 | 400 | 0.27                   | 13.0             | 24.0   | 41.5   | 37.5             | 4,500        | 9,000,000                               | 73QW3270(1)40(2)           | R73QW3270(1)40(2)    |
| 1,000 | 400 | 0.27                   | 16.0             | 28.5   | 41.5   | 37.5             | 4,500        | 9,000,000                               | 73QW3270(1)30(2)           | R73QW3270(1)30(2)    |
| 1,000 | 400 | 0.27                   | 24.0             | 15.0   | 41.5   | 37.5             | 4,500        | 9,000,000                               | 73QW3270(1)L0(2)           | R73QW3270(1)L0(2)    |
| 1,000 | 400 | 0.33                   | 16.0             | 28.5   | 41.5   | 37.5             | 4,500        | 9,000,000                               | 73QW3330(1)30(2)           | R73QW3330(1)30(2)    |
| 1,000 | 400 | 0.33                   | 24.0             | 19.0   | 41.5   | 37.5             | 4,500        | 9,000,000                               | 73QW3330(1)L0(2)           | R73QW3330(1)L0(2)    |
| 1,000 | 400 | 0.39                   | 16.0             | 28.5   | 41.5   | 37.5             | 4,500        | 9,000,000                               | 73QW3390(1)30(2)           | R73QW3390(1)30(2)    |
| 1,000 | 400 | 0.47                   | 19.0             | 32.0   | 41.5   | 37.5             | 4,500        | 9,000,000                               | 73QW3470(1)30(2)           | R73QW3470(1)30(2)    |
| 1,000 | 400 | 0.56                   | 19.0             | 32.0   | 41.5   | 37.5             | 4,500        | 9,000,000                               | 73QW3560(1)30(2)           | R73QW3560(1)30(2)    |
| 1,000 | 400 | 0.68                   | 20.0             | 40.0   | 41.5   | 37.5             | 4,500        | 9,000,000                               | 73QW3680(1)30(2)           | R73QW3680(1)30(2)    |
| 1,000 | 400 | 0.82                   | 20.0             | 40.0   | 41.5   | 37.5             | 4,500        | 9,000,000                               | 73QW3820(1)30(2)           | R73QW3820(1)30(2)    |
| 1,000 | 400 | 1.0                    | 24.0             | 44.0   | 41.5   | 37.5             | 4,500        | 9,000,000                               | 73QW4100(1)30(2)           | R73QW4100(1)30(2)    |
| 1,000 | 400 | 1.2                    | 30.0             | 45.0   | 41.5   | 37.5             | 4,500        | 9,000,000                               | 73QW4120(1)30(2)           | R73QW4120(1)30(2)    |
| 1,000 | 400 | 1.5                    | 30.0             | 45.0   | 41.5   | 37.5             | 4,500        | 9,000,000                               | 73QW4150(1)40(2)           | R73QW4150(1)40(2)    |
| 1,250 | 450 | 0.0022                 | 5.0              | 11.0   | 18.0   | 15.0             | 30,000       | 75,000,000                              | 73RI1220(1)00(2)           | R73RI1220(1)00(2)    |
| 1,250 | 450 | 0.0027                 | 5.0              | 11.0   | 18.0   | 15.0             | 30,000       | 75,000,000                              | 73RI1270(1)00(2)           | R73RI1270(1)00(2)    |
| 1,250 | 450 | 0.0033                 | 6.0              | 12.0   | 18.0   | 15.0             | 30,000       | 75,000,000                              | 73RI1330(1)00(2)           | R73RI1330(1)00(2)    |
| 1,250 | 450 | 0.0039                 | 6.0              | 12.0   | 18.0   | 15.0             | 30,000       | 75,000,000                              | 73RI1390(1)00(2)           | R73RI1390(1)00(2)    |
| 1,250 | 450 | 0.0047                 | 7.5              | 13.5   | 18.0   | 15.0             | 30,000       | 75,000,000                              | 73RI1470(1)00(2)           | R73RI1470(1)00(2)    |
| 1,250 | 450 | 0.0056                 | 7.5              | 13.5   | 18.0   | 15.0             | 30,000       | 75,000,000                              | 73RI1560(1)00(2)           | R73RI1560(1)00(2)    |
| 1,250 | 450 | 0.0068                 | 8.5              | 14.5   | 18.0   | 15.0             | 30,000       | 75,000,000                              | 73RI1680(1)00(2)           | R73RI1680(1)00(2)    |
| 1,250 | 450 | 0.0082                 | 10.0             | 16.0   | 18.0   | 15.0             | 30,000       | 75,000,000                              | 73RI1820(1)00(2)           | R73RI1820(1)00(2)    |
| 1,250 | 450 | 0.0082                 | 6.0              | 15.0   | 26.5   | 22.5             | 11,000       | 27,500,000                              | 73RN1820(1)00(2)           | R73RN1820(1)00(2)    |
| 1,250 | 450 | 0.010                  | 6.0              | 15.0   | 26.5   | 22.5             | 11,000       | 27,500,000                              | 73RN2100(1)00(2)           | R73RN2100(1)00(2)    |
| 1,250 | 450 | 0.012                  | 6.0              | 15.0   | 26.5   | 22.5             | 11,000       | 27,500,000                              | 73RN2120(1)00(2)           | R73RN2120(1)00(2)    |
| 1,250 | 450 | 0.015                  | 7.0              | 16.0   | 26.5   | 22.5             | 11,000       | 27,500,000                              | 73RN2150(1)00(2)           | R73RN2150(1)00(2)    |
| VDC   | VAC | Capacitance Value (µF) | B (mm)           | H (mm) | L (mm) | Lead Spacing (p) | dV/dt (V/µs) | Max K <sub>0</sub> (V <sup>2</sup> /µs) | KEMET Internal Part Number | Customer Part Number |

(1) Insert lead and packaging code. See Ordering Options Table for available options.

(2) H = 2.5%, J = 5%, K = 10%, M = 20%

**Table 1 – Ratings & Part Number Reference cont.**

| VDC   | VAC | Capacitance Value (µF) | Dimensions in mm |        |        | Lead Spacing (p) | dV/dt (V/µs) | Max K <sub>0</sub> (V <sup>2</sup> /µs) | KEMET Internal Part Number | Customer Part Number |
|-------|-----|------------------------|------------------|--------|--------|------------------|--------------|---|----------------------------|----------------------|
|       |     |                        | B                | H      | L      |                  |              |   |                            |                      |
| 1,250 | 450 | 0.018                  | 7.0              | 16.0   | 26.5   | 22.5             | 11,000       | 27,500,000                              | 73RN2180(1)00(2)           | R73RN2180(1)00(2)    |
| 1,250 | 450 | 0.022                  | 8.5              | 17.0   | 26.5   | 22.5             | 11,000       | 27,500,000                              | 73RN2220(1)00(2)           | R73RN2220(1)00(2)    |
| 1,250 | 450 | 0.027                  | 10.0             | 18.5   | 26.5   | 22.5             | 11,000       | 27,500,000                              | 73RN2270(1)00(2)           | R73RN2270(1)00(2)    |
| 1,250 | 450 | 0.033                  | 10.0             | 18.5   | 26.5   | 22.5             | 11,000       | 27,500,000                              | 73RN2330(1)00(2)           | R73RN2330(1)00(2)    |
| 1,250 | 450 | 0.039                  | 9.0              | 17.0   | 32.0   | 27.5             | 11,000       | 27,500,000                              | 73RR2390(1)00(2)           | R73RR2390(1)00(2)    |
| 1,250 | 450 | 0.047                  | 11.0             | 20.0   | 32.0   | 27.5             | 11,000       | 27,500,000                              | 73RR2470(1)00(2)           | R73RR2470(1)00(2)    |
| 1,250 | 450 | 0.056                  | 11.0             | 20.0   | 32.0   | 27.5             | 11,000       | 27,500,000                              | 73RR2560(1)00(2)           | R73RR2560(1)00(2)    |
| 1,250 | 450 | 0.056                  | 24.0             | 15.0   | 32.0   | 27.5             | 11,000       | 27,500,000                              | 73RR2560(1)L0(2)           | R73RR2560(1)L0(2)    |
| 1,250 | 450 | 0.068                  | 13.0             | 22.0   | 32.0   | 27.5             | 11,000       | 27,500,000                              | 73RR2680(1)00(2)           | R73RR2680(1)00(2)    |
| 1,250 | 450 | 0.068                  | 24.0             | 15.0   | 32.0   | 27.5             | 11,000       | 27,500,000                              | 73RR2680(1)L0(2)           | R73RR2680(1)L0(2)    |
| 1,250 | 450 | 0.082                  | 13.0             | 25.0   | 32.0   | 27.5             | 11,000       | 27,500,000                              | 73RR2820(1)10(2)           | R73RR2820(1)10(2)    |
| 1,250 | 450 | 0.082                  | 24.0             | 15.0   | 32.0   | 27.5             | 11,000       | 27,500,000                              | 73RR2820(1)L0(2)           | R73RR2820(1)L0(2)    |
| 1,250 | 450 | 0.10                   | 13.0             | 25.0   | 32.0   | 27.5             | 11,000       | 27,500,000                              | 73RR3100(1)10(2)           | R73RR3100(1)10(2)    |
| 1,250 | 450 | 0.10                   | 24.0             | 15.0   | 32.0   | 27.5             | 11,000       | 27,500,000                              | 73RR3100(1)L0(2)           | R73RR3100(1)L0(2)    |
| 1,250 | 450 | 0.12                   | 14.0             | 28.0   | 32.0   | 27.5             | 11,000       | 27,500,000                              | 73RR3120(1)10(2)           | R73RR3120(1)10(2)    |
| 1,250 | 450 | 0.12                   | 18.0             | 33.0   | 32.0   | 27.5             | 11,000       | 27,500,000                              | 73RR3120(1)00(2)           | R73RR3120(1)00(2)    |
| 1,250 | 450 | 0.15                   | 18.0             | 33.0   | 32.0   | 27.5             | 11,000       | 27,500,000                              | 73RR3150(1)00(2)           | R73RR3150(1)00(2)    |
| 1,250 | 450 | 0.18                   | 18.0             | 33.0   | 32.0   | 27.5             | 11,000       | 27,500,000                              | 73RR3180(1)00(2)           | R73RR3180(1)00(2)    |
| 1,250 | 450 | 0.22                   | 22.0             | 37.0   | 32.0   | 27.5             | 11,000       | 27,500,000                              | 73RR3220(1)00(2)           | R73RR3220(1)00(2)    |
| 1,250 | 450 | 0.082                  | 11.0             | 22.0   | 41.5   | 37.5             | 5,500        | 13,750,000                              | 73RW2820(1)00(2)           | R73RW2820(1)00(2)    |
| 1,250 | 450 | 0.10                   | 11.0             | 22.0   | 41.5   | 37.5             | 5,500        | 13,750,000                              | 73RW3100(1)00(2)           | R73RW3100(1)00(2)    |
| 1,250 | 450 | 0.10                   | 24.0             | 15.0   | 41.5   | 37.5             | 5,500        | 13,750,000                              | 73RW3100(1)L0(2)           | R73RW3100(1)L0(2)    |
| 1,250 | 450 | 0.12                   | 11.0             | 22.0   | 41.5   | 37.5             | 5,500        | 13,750,000                              | 73RW3120(1)10(2)           | R73RW3120(1)10(2)    |
| 1,250 | 450 | 0.12                   | 13.0             | 24.0   | 41.5   | 37.5             | 5,500        | 13,750,000                              | 73RW3120(1)00(2)           | R73RW3120(1)00(2)    |
| 1,250 | 450 | 0.12                   | 24.0             | 15.0   | 41.5   | 37.5             | 5,500        | 13,750,000                              | 73RW3120(1)L0(2)           | R73RW3120(1)L0(2)    |
| 1,250 | 450 | 0.15                   | 13.0             | 24.0   | 41.5   | 37.5             | 5,500        | 13,750,000                              | 73RW3150(1)00(2)           | R73RW3150(1)00(2)    |
| 1,250 | 450 | 0.15                   | 24.0             | 15.0   | 41.5   | 37.5             | 5,500        | 13,750,000                              | 73RW3150(1)L0(2)           | R73RW3150(1)L0(2)    |
| 1,250 | 450 | 0.18                   | 13.0             | 24.0   | 41.5   | 37.5             | 5,500        | 13,750,000                              | 73RW3180(1)10(2)           | R73RW3180(1)10(2)    |
| 1,250 | 450 | 0.18                   | 16.0             | 28.5   | 41.5   | 37.5             | 5,500        | 13,750,000                              | 73RW3180(1)00(2)           | R73RW3180(1)00(2)    |
| 1,250 | 450 | 0.18                   | 24.0             | 15.0   | 41.5   | 37.5             | 5,500        | 13,750,000                              | 73RW3180(1)L0(2)           | R73RW3180(1)L0(2)    |
| 1,250 | 450 | 0.22                   | 16.0             | 28.5   | 41.5   | 37.5             | 5,500        | 13,750,000                              | 73RW3220(1)00(2)           | R73RW3220(1)00(2)    |
| 1,250 | 450 | 0.22                   | 24.0             | 19.0   | 41.5   | 37.5             | 5,500        | 13,750,000                              | 73RW3220(1)L0(2)           | R73RW3220(1)L0(2)    |
| 1,250 | 450 | 0.27                   | 16.0             | 28.5   | 41.5   | 37.5             | 5,500        | 13,750,000                              | 73RW3270(1)00(2)           | R73RW3270(1)00(2)    |
| 1,250 | 450 | 0.33                   | 19.0             | 32.0   | 41.5   | 37.5             | 5,500        | 13,750,000                              | 73RW3330(1)00(2)           | R73RW3330(1)00(2)    |
| 1,250 | 450 | 0.39                   | 20.0             | 40.0   | 41.5   | 37.5             | 5,500        | 13,750,000                              | 73RW3390(1)00(2)           | R73RW3390(1)00(2)    |
| 1,250 | 450 | 0.47                   | 20.0             | 40.0   | 41.5   | 37.5             | 5,500        | 13,750,000                              | 73RW3470(1)00(2)           | R73RW3470(1)00(2)    |
| 1,250 | 450 | 0.56                   | 20.0             | 40.0   | 41.5   | 37.5             | 5,500        | 13,750,000                              | 73RW3560(1)00(2)           | R73RW3560(1)00(2)    |
| 1,250 | 450 | 0.68                   | 24.0             | 44.0   | 41.5   | 37.5             | 5,500        | 13,750,000                              | 73RW3680(1)00(2)           | R73RW3680(1)00(2)    |
| 1,250 | 450 | 0.82                   | 30.0             | 45.0   | 41.5   | 37.5             | 5,500        | 13,750,000                              | 73RW3820(1)00(2)           | R73RW3820(1)00(2)    |
| 1,600 | 450 | 0.0010                 | 5.0              | 11.0   | 18.0   | 15.0             | 34,000       | 108,800,000                             | 73TI1100(1)00(2)           | R73TI1100(1)00(2)    |
| 1,600 | 450 | 0.0012                 | 5.0              | 11.0   | 18.0   | 15.0             | 34,000       | 108,800,000                             | 73TI1120(1)00(2)           | R73TI1120(1)00(2)    |
| 1,600 | 450 | 0.0015                 | 5.0              | 11.0   | 18.0   | 15.0             | 34,000       | 108,800,000                             | 73TI1150(1)00(2)           | R73TI1150(1)00(2)    |
| 1,600 | 450 | 0.0018                 | 5.0              | 11.0   | 18.0   | 15.0             | 34,000       | 108,800,000                             | 73TI1180(1)00(2)           | R73TI1180(1)00(2)    |
| 1,600 | 450 | 0.0022                 | 6.0              | 12.0   | 18.0   | 15.0             | 34,000       | 108,800,000                             | 73TI1220(1)00(2)           | R73TI1220(1)00(2)    |
| 1,600 | 450 | 0.0027                 | 6.0              | 12.0   | 18.0   | 15.0             | 34,000       | 108,800,000                             | 73TI1270(1)00(2)           | R73TI1270(1)00(2)    |
| 1,600 | 450 | 0.0033                 | 7.5              | 13.5   | 18.0   | 15.0             | 34,000       | 108,800,000                             | 73TI1330(1)00(2)           | R73TI1330(1)00(2)    |
| 1,600 | 450 | 0.0039                 | 7.5              | 13.5   | 18.0   | 15.0             | 34,000       | 108,800,000                             | 73TI1390(1)00(2)           | R73TI1390(1)00(2)    |
| 1,600 | 450 | 0.0047                 | 8.5              | 14.5   | 18.0   | 15.0             | 34,000       | 108,800,000                             | 73TI1470(1)00(2)           | R73TI1470(1)00(2)    |
| 1,600 | 450 | 0.0056                 | 10.0             | 16.0   | 18.0   | 15.0             | 34,000       | 108,800,000                             | 73TI1560(1)00(2)           | R73TI1560(1)00(2)    |
| 1,600 | 450 | 0.0068                 | 10.0             | 16.0   | 18.0   | 15.0             | 34,000       | 108,800,000                             | 73TI1680(1)00(2)           | R73TI1680(1)00(2)    |
| 1,600 | 450 | 0.0056                 | 6.0              | 15.0   | 26.5   | 22.5             | 11,000       | 35,200,000                              | 73TN1560(1)00(2)           | R73TN1560(1)00(2)    |
| 1,600 | 450 | 0.0068                 | 6.0              | 15.0   | 26.5   | 22.5             | 11,000       | 35,200,000                              | 73TN1680(1)00(2)           | R73TN1680(1)00(2)    |
| 1,600 | 450 | 0.0082                 | 6.0              | 15.0   | 26.5   | 22.5             | 11,000       | 35,200,000                              | 73TN1820(1)00(2)           | R73TN1820(1)00(2)    |
| 1,600 | 450 | 0.010                  | 6.0              | 15.0   | 26.5   | 22.5             | 11,000       | 35,200,000                              | 73TN2100(1)00(2)           | R73TN2100(1)00(2)    |
| 1,600 | 450 | 0.012                  | 7.0              | 16.0   | 26.5   | 22.5             | 11,000       | 35,200,000                              | 73TN2120(1)00(2)           | R73TN2120(1)00(2)    |
| 1,600 | 450 | 0.015                  | 8.5              | 17.0   | 26.5   | 22.5             | 11,000       | 35,200,000                              | 73TN2150(1)00(2)           | R73TN2150(1)00(2)    |
| 1,600 | 450 | 0.018                  | 8.5              | 17.0   | 26.5   | 22.5             | 11,000       | 35,200,000                              | 73TN2180(1)00(2)           | R73TN2180(1)00(2)    |
| 1,600 | 450 | 0.022                  | 10.0             | 18.5   | 26.5   | 22.5             | 11,000       | 35,200,000                              | 73TN2220(1)00(2)           | R73TN2220(1)00(2)    |
| 1,600 | 450 | 0.027                  | 9.0              | 17.0   | 32.0   | 27.5             | 11,000       | 35,200,000                              | 73TR2270(1)00(2)           | R73TR2270(1)00(2)    |
| 1,600 | 450 | 0.033                  | 11.0             | 20.0   | 32.0   | 27.5             | 11,000       | 35,200,000                              | 73TR2330(1)00(2)           | R73TR2330(1)00(2)    |
| VDC   | VAC | Capacitance Value (µF) | B (mm)           | H (mm) | L (mm) | Lead Spacing (p) | dV/dt (V/µs) | Max K <sub>0</sub> (V <sup>2</sup> /µs) | KEMET Internal Part Number | Customer Part Number |

(1) Insert lead and packaging code. See Ordering Options Table for available options.

(2) H = 2.5%, J = 5%, K = 10%, M = 20%

**Table 1 – Ratings & Part Number Reference cont.**

| VDC   | VAC | Capacitance Value (µF) | Dimensions in mm |        |        | Lead Spacing (p) | dV/dt (V/µs) | Max K <sub>0</sub> (V <sup>2</sup> /µs) | KEMET Internal Part Number | Customer Part Number |
|-------|-----|------------------------|------------------|--------|--------|------------------|--------------|---|----------------------------|----------------------|
|       |     |                        | B                | H      | L      |                  |              |   |                            |                      |
| 1,600 | 450 | 0.039                  | 11.0             | 20.0   | 32.0   | 27.5             | 11,000       | 35,200,000                              | 73TR2390(1)00(2)           | R73TR2390(1)00(2)    |
| 1,600 | 450 | 0.039                  | 24.0             | 15.0   | 32.0   | 27.5             | 11,000       | 35,200,000                              | 73TR2390(1)L0(2)           | R73TR2390(1)L0(2)    |
| 1,600 | 450 | 0.047                  | 13.0             | 22.0   | 32.0   | 27.5             | 11,000       | 35,200,000                              | 73TR2470(1)00(2)           | R73TR2470(1)00(2)    |
| 1,600 | 450 | 0.047                  | 24.0             | 15.0   | 32.0   | 27.5             | 11,000       | 35,200,000                              | 73TR2470(1)L0(2)           | R73TR2470(1)L0(2)    |
| 1,600 | 450 | 0.056                  | 13.0             | 22.0   | 32.0   | 27.5             | 11,000       | 35,200,000                              | 73TR2560(1)00(2)           | R73TR2560(1)00(2)    |
| 1,600 | 450 | 0.056                  | 24.0             | 15.0   | 32.0   | 27.5             | 11,000       | 35,200,000                              | 73TR2560(1)L0(2)           | R73TR2560(1)L0(2)    |
| 1,600 | 450 | 0.068                  | 14.0             | 28.0   | 32.0   | 27.5             | 11,000       | 35,200,000                              | 73TR2680(1)10(2)           | R73TR2680(1)10(2)    |
| 1,600 | 450 | 0.068                  | 24.0             | 15.0   | 32.0   | 27.5             | 11,000       | 35,200,000                              | 73TR2680(1)L0(2)           | R73TR2680(1)L0(2)    |
| 1,600 | 450 | 0.082                  | 14.0             | 28.0   | 32.0   | 27.5             | 11,000       | 35,200,000                              | 73TR2820(1)00(2)           | R73TR2820(1)00(2)    |
| 1,600 | 450 | 0.10                   | 18.0             | 33.0   | 32.0   | 27.5             | 11,000       | 35,200,000                              | 73TR3100(1)00(2)           | R73TR3100(1)00(2)    |
| 1,600 | 450 | 0.12                   | 18.0             | 33.0   | 32.0   | 27.5             | 11,000       | 35,200,000                              | 73TR3120(1)00(2)           | R73TR3120(1)00(2)    |
| 1,600 | 450 | 0.15                   | 22.0             | 37.0   | 32.0   | 27.5             | 11,000       | 35,200,000                              | 73TR3150(1)00(2)           | R73TR3150(1)00(2)    |
| 1,600 | 450 | 0.18                   | 22.0             | 37.0   | 32.0   | 27.5             | 11,000       | 35,200,000                              | 73TR3180(1)00(2)           | R73TR3180(1)00(2)    |
| 1,600 | 450 | 0.033                  | 11.0             | 22.0   | 41.5   | 37.5             | 6,500        | 20,800,000                              | 73TW2330(1)00(2)           | R73TW2330(1)00(2)    |
| 1,600 | 450 | 0.039                  | 11.0             | 22.0   | 41.5   | 37.5             | 6,500        | 20,800,000                              | 73TW2390(1)00(2)           | R73TW2390(1)00(2)    |
| 1,600 | 450 | 0.047                  | 11.0             | 22.0   | 41.5   | 37.5             | 6,500        | 20,800,000                              | 73TW2470(1)00(2)           | R73TW2470(1)00(2)    |
| 1,600 | 450 | 0.056                  | 11.0             | 22.0   | 41.5   | 37.5             | 6,500        | 20,800,000                              | 73TW2560(1)00(2)           | R73TW2560(1)00(2)    |
| 1,600 | 450 | 0.068                  | 11.0             | 22.0   | 41.5   | 37.5             | 6,500        | 20,800,000                              | 73TW2680(1)00(2)           | R73TW2680(1)00(2)    |
| 1,600 | 450 | 0.068                  | 24.0             | 15.0   | 41.5   | 37.5             | 6,500        | 20,800,000                              | 73TW2680(1)L0(2)           | R73TW2680(1)L0(2)    |
| 1,600 | 450 | 0.082                  | 11.0             | 22.0   | 41.5   | 37.5             | 6,500        | 20,800,000                              | 73TW2820(1)00(2)           | R73TW2820(1)00(2)    |
| 1,600 | 450 | 0.082                  | 24.0             | 15.0   | 41.5   | 37.5             | 6,500        | 20,800,000                              | 73TW2820(1)L0(2)           | R73TW2820(1)L0(2)    |
| 1,600 | 450 | 0.10                   | 13.0             | 24.0   | 41.5   | 37.5             | 6,500        | 20,800,000                              | 73TW3100(1)00(2)           | R73TW3100(1)00(2)    |
| 1,600 | 450 | 0.10                   | 24.0             | 15.0   | 41.5   | 37.5             | 6,500        | 20,800,000                              | 73TW3100(1)L0(2)           | R73TW3100(1)L0(2)    |
| 1,600 | 450 | 0.12                   | 16.0             | 28.5   | 41.5   | 37.5             | 6,500        | 20,800,000                              | 73TW3120(1)00(2)           | R73TW3120(1)00(2)    |
| 1,600 | 450 | 0.12                   | 24.0             | 19.0   | 41.5   | 37.5             | 6,500        | 20,800,000                              | 73TW3120(1)L0(2)           | R73TW3120(1)L0(2)    |
| 1,600 | 450 | 0.15                   | 16.0             | 28.5   | 41.5   | 37.5             | 6,500        | 20,800,000                              | 73TW3150(1)00(2)           | R73TW3150(1)00(2)    |
| 1,600 | 450 | 0.15                   | 24.0             | 19.0   | 41.5   | 37.5             | 6,500        | 20,800,000                              | 73TW3150(1)L0(2)           | R73TW3150(1)L0(2)    |
| 1,600 | 450 | 0.18                   | 16.0             | 28.5   | 41.5   | 37.5             | 6,500        | 20,800,000                              | 73TW3180(1)00(2)           | R73TW3180(1)00(2)    |
| 1,600 | 450 | 0.22                   | 19.0             | 32.0   | 41.5   | 37.5             | 6,500        | 20,800,000                              | 73TW3220(1)00(2)           | R73TW3220(1)00(2)    |
| 1,600 | 450 | 0.27                   | 20.0             | 40.0   | 41.5   | 37.5             | 6,500        | 20,800,000                              | 73TW3270(1)00(2)           | R73TW3270(1)00(2)    |
| 1,600 | 450 | 0.33                   | 20.0             | 40.0   | 41.5   | 37.5             | 6,500        | 20,800,000                              | 73TW3330(1)00(2)           | R73TW3330(1)00(2)    |
| 1,600 | 450 | 0.39                   | 24.0             | 44.0   | 41.5   | 37.5             | 6,500        | 20,800,000                              | 73TW3390(1)00(2)           | R73TW3390(1)00(2)    |
| 1,600 | 450 | 0.47                   | 24.0             | 44.0   | 41.5   | 37.5             | 6,500        | 20,800,000                              | 73TW3470(1)10(2)           | R73TW3470(1)10(2)    |
| 1,600 | 450 | 0.47                   | 30.0             | 45.0   | 41.5   | 37.5             | 6,500        | 20,800,000                              | 73TW3470(1)00(2)           | R73TW3470(1)00(2)    |
| 1,600 | 450 | 0.56                   | 24.0             | 44.0   | 41.5   | 37.5             | 6,500        | 20,800,000                              | 73TW3560(1)10(2)           | R73TW3560(1)10(2)    |
| 1,600 | 450 | 0.56                   | 30.0             | 45.0   | 41.5   | 37.5             | 6,500        | 20,800,000                              | 73TW3560(1)00(2)           | R73TW3560(1)00(2)    |
| 2,000 | 500 | 0.00010                | 5.0              | 11.0   | 18.0   | 15.0             | 54,000       | 216,000,000                             | 73UI0100(1)00(2)           | R73UI0100(1)00(2)    |
| 2,000 | 500 | 0.00015                | 5.0              | 11.0   | 18.0   | 15.0             | 54,000       | 216,000,000                             | 73UI0150(1)00(2)           | R73UI0150(1)00(2)    |
| 2,000 | 500 | 0.00022                | 5.0              | 11.0   | 18.0   | 15.0             | 54,000       | 216,000,000                             | 73UI0220(1)00(2)           | R73UI0220(1)00(2)    |
| 2,000 | 500 | 0.00033                | 5.0              | 11.0   | 18.0   | 15.0             | 54,000       | 216,000,000                             | 73UI0330(1)00(2)           | R73UI0330(1)00(2)    |
| 2,000 | 500 | 0.00047                | 5.0              | 11.0   | 18.0   | 15.0             | 54,000       | 216,000,000                             | 73UI0470(1)00(2)           | R73UI0470(1)00(2)    |
| 2,000 | 500 | 0.00068                | 5.0              | 11.0   | 18.0   | 15.0             | 54,000       | 216,000,000                             | 73UI0680(1)00(2)           | R73UI0680(1)00(2)    |
| 2,000 | 500 | 0.0010                 | 6.0              | 12.0   | 18.0   | 15.0             | 54,000       | 216,000,000                             | 73UI1100(1)00(2)           | R73UI1100(1)00(2)    |
| 2,000 | 500 | 0.0012                 | 6.0              | 12.0   | 18.0   | 15.0             | 54,000       | 216,000,000                             | 73UI1120(1)00(2)           | R73UI1120(1)00(2)    |
| 2,000 | 500 | 0.0015                 | 7.5              | 13.5   | 18.0   | 15.0             | 54,000       | 216,000,000                             | 73UI1150(1)00(2)           | R73UI1150(1)00(2)    |
| 2,000 | 500 | 0.0018                 | 7.5              | 13.5   | 18.0   | 15.0             | 54,000       | 216,000,000                             | 73UI1180(1)00(2)           | R73UI1180(1)00(2)    |
| 2,000 | 500 | 0.0022                 | 8.5              | 14.5   | 18.0   | 15.0             | 54,000       | 216,000,000                             | 73UI1220(1)00(2)           | R73UI1220(1)00(2)    |
| 2,000 | 500 | 0.0027                 | 10.0             | 16.0   | 18.0   | 15.0             | 54,000       | 216,000,000                             | 73UI1270(1)00(2)           | R73UI1270(1)00(2)    |
| 2,000 | 500 | 0.0027                 | 6.0              | 15.0   | 26.5   | 22.5             | 11,000       | 44,000,000                              | 73UN1270(1)00(2)           | R73UN1270(1)00(2)    |
| 2,000 | 500 | 0.0033                 | 6.0              | 15.0   | 26.5   | 22.5             | 11,000       | 44,000,000                              | 73UN1330(1)00(2)           | R73UN1330(1)00(2)    |
| 2,000 | 500 | 0.0039                 | 6.0              | 15.0   | 26.5   | 22.5             | 11,000       | 44,000,000                              | 73UN1390(1)00(2)           | R73UN1390(1)00(2)    |
| 2,000 | 500 | 0.0047                 | 7.0              | 16.0   | 26.5   | 22.5             | 11,000       | 44,000,000                              | 73UN1470(1)00(2)           | R73UN1470(1)00(2)    |
| 2,000 | 500 | 0.0056                 | 7.0              | 16.0   | 26.5   | 22.5             | 11,000       | 44,000,000                              | 73UN1560(1)00(2)           | R73UN1560(1)00(2)    |
| 2,000 | 500 | 0.0068                 | 8.5              | 17.0   | 26.5   | 22.5             | 11,000       | 44,000,000                              | 73UN1680(1)00(2)           | R73UN1680(1)00(2)    |
| 2,000 | 500 | 0.0082                 | 8.5              | 17.0   | 26.5   | 22.5             | 11,000       | 44,000,000                              | 73UN1820(1)00(2)           | R73UN1820(1)00(2)    |
| 2,000 | 500 | 0.010                  | 10.0             | 18.5   | 26.5   | 22.5             | 11,000       | 44,000,000                              | 73UN2100(1)00(2)           | R73UN2100(1)00(2)    |
| 2,000 | 500 | 0.012                  | 11.0             | 20.0   | 26.5   | 22.5             | 11,000       | 44,000,000                              | 73UN2120(1)00(2)           | R73UN2120(1)00(2)    |
| 2,000 | 500 | 0.010                  | 9.0              | 17.0   | 32.0   | 27.5             | 11,000       | 44,000,000                              | 73UR2100(1)00(2)           | R73UR2100(1)00(2)    |
| 2,000 | 500 | 0.012                  | 9.0              | 17.0   | 32.0   | 27.5             | 11,000       | 44,000,000                              | 73UR2120(1)00(2)           | R73UR2120(1)00(2)    |
| 2,000 | 500 | 0.012                  | 24.0             | 15.0   | 32.0   | 27.5             | 11,000       | 44,000,000                              | 73UR2120(1)L0(2)           | R73UR2120(1)L0(2)    |
| VDC   | VAC | Capacitance Value (µF) | B (mm)           | H (mm) | L (mm) | Lead Spacing (p) | dV/dt (V/µs) | Max K <sub>0</sub> (V <sup>2</sup> /µs) | KEMET Internal Part Number | Customer Part Number |

(1) Insert lead and packaging code. See Ordering Options Table for available options.

(2) H = ±2.5% (for 2-section construction only), J = ±5%, K = ±10%.



**Table 1 – Ratings & Part Number Reference cont.**

| VDC   | VAC | Capacitance Value (µF) | Dimensions in mm |        |        | Lead Spacing (p) | dV/dt (V/µs) | Max K <sub>0</sub> (V <sup>2</sup> /µs) | KEMET Internal Part Number | Customer Part Number |
|-------|-----|------------------------|------------------|--------|--------|------------------|--------------|---|----------------------------|----------------------|
|       |     |                        | B                | H      | L      |                  |              |   |                            |                      |
| 2,000 | 500 | 0.015                  | 11.0             | 20.0   | 32.0   | 27.5             | 11,000       | 44,000,000                              | 73UR2150(1)00(2)           | R73UR2150(1)00(2)    |
| 2,000 | 500 | 0.015                  | 24.0             | 15.0   | 32.0   | 27.5             | 11,000       | 44,000,000                              | 73UR2150(1)L0(2)           | R73UR2150(1)L0(2)    |
| 2,000 | 500 | 0.018                  | 13.0             | 22.0   | 32.0   | 27.5             | 11,000       | 44,000,000                              | 73UR2180(1)00(2)           | R73UR2180(1)00(2)    |
| 2,000 | 500 | 0.018                  | 24.0             | 15.0   | 32.0   | 27.5             | 11,000       | 44,000,000                              | 73UR2180(1)L0(2)           | R73UR2180(1)L0(2)    |
| 2,000 | 500 | 0.022                  | 13.0             | 22.0   | 32.0   | 27.5             | 11,000       | 44,000,000                              | 73UR2220(1)00(2)           | R73UR2220(1)00(2)    |
| 2,000 | 500 | 0.027                  | 14.0             | 28.0   | 32.0   | 27.5             | 11,000       | 44,000,000                              | 73UR2270(1)10(2)           | R73UR2270(1)10(2)    |
| 2,000 | 500 | 0.033                  | 14.0             | 28.0   | 32.0   | 27.5             | 11,000       | 44,000,000                              | 73UR2330(1)10(2)           | R73UR2330(1)10(2)    |
| 2,000 | 500 | 0.033                  | 18.0             | 33.0   | 32.0   | 27.5             | 11,000       | 44,000,000                              | 73UR2330(1)00(2)           | R73UR2330(1)00(2)    |
| 2,000 | 500 | 0.039                  | 18.0             | 33.0   | 32.0   | 27.5             | 11,000       | 44,000,000                              | 73UR2390(1)00(2)           | R73UR2390(1)00(2)    |
| 2,000 | 500 | 0.047                  | 18.0             | 33.0   | 32.0   | 27.5             | 11,000       | 44,000,000                              | 73UR2470(1)00(2)           | R73UR2470(1)00(2)    |
| 2,000 | 500 | 0.056                  | 22.0             | 37.0   | 32.0   | 27.5             | 11,000       | 44,000,000                              | 73UR2560(1)00(2)           | R73UR2560(1)00(2)    |
| 2,000 | 500 | 0.068                  | 22.0             | 37.0   | 32.0   | 27.5             | 11,000       | 44,000,000                              | 73UR2680(1)00(2)           | R73UR2680(1)00(2)    |
| 2,000 | 500 | 0.018                  | 11.0             | 22.0   | 41.5   | 37.5             | 9,000        | 36,000,000                              | 73UW2180(1)00(2)           | R73UW2180(1)00(2)    |
| 2,000 | 500 | 0.018                  | 24.0             | 15.0   | 41.5   | 37.5             | 9,000        | 36,000,000                              | 73UW2180(1)L0(2)           | R73UW2180(1)L0(2)    |
| 2,000 | 500 | 0.022                  | 11.0             | 22.0   | 41.5   | 37.5             | 9,000        | 36,000,000                              | 73UW2220(1)00(2)           | R73UW2220(1)00(2)    |
| 2,000 | 500 | 0.022                  | 24.0             | 15.0   | 41.5   | 37.5             | 9,000        | 36,000,000                              | 73UW2220(1)L0(2)           | R73UW2220(1)L0(2)    |
| 2,000 | 500 | 0.027                  | 11.0             | 22.0   | 41.5   | 37.5             | 9,000        | 36,000,000                              | 73UW2270(1)00(2)           | R73UW2270(1)00(2)    |
| 2,000 | 500 | 0.027                  | 24.0             | 15.0   | 41.5   | 37.5             | 9,000        | 36,000,000                              | 73UW2270(1)L0(2)           | R73UW2270(1)L0(2)    |
| 2,000 | 500 | 0.033                  | 13.0             | 24.0   | 41.5   | 37.5             | 9,000        | 36,000,000                              | 73UW2330(1)00(2)           | R73UW2330(1)00(2)    |
| 2,000 | 500 | 0.033                  | 24.0             | 15.0   | 41.5   | 37.5             | 9,000        | 36,000,000                              | 73UW2330(1)L0(2)           | R73UW2330(1)L0(2)    |
| 2,000 | 500 | 0.039                  | 13.0             | 24.0   | 41.5   | 37.5             | 9,000        | 36,000,000                              | 73UW2390(1)00(2)           | R73UW2390(1)00(2)    |
| 2,000 | 500 | 0.039                  | 24.0             | 19.0   | 41.5   | 37.5             | 9,000        | 36,000,000                              | 73UW2390(1)L0(2)           | R73UW2390(1)L0(2)    |
| 2,000 | 500 | 0.047                  | 16.0             | 28.5   | 41.5   | 37.5             | 9,000        | 36,000,000                              | 73UW2470(1)00(2)           | R73UW2470(1)00(2)    |
| 2,000 | 500 | 0.056                  | 16.0             | 28.5   | 41.5   | 37.5             | 9,000        | 36,000,000                              | 73UW2560(1)00(2)           | R73UW2560(1)00(2)    |
| 2,000 | 500 | 0.068                  | 16.0             | 28.5   | 41.5   | 37.5             | 9,000        | 36,000,000                              | 73UW2680(1)00(2)           | R73UW2680(1)00(2)    |
| 2,000 | 500 | 0.082                  | 19.0             | 32.0   | 41.5   | 37.5             | 9,000        | 36,000,000                              | 73UW2820(1)00(2)           | R73UW2820(1)00(2)    |
| 2,000 | 500 | 0.10                   | 20.0             | 40.0   | 41.5   | 37.5             | 9,000        | 36,000,000                              | 73UW3100(1)00(2)           | R73UW3100(1)00(2)    |
| 2,000 | 500 | 0.12                   | 20.0             | 40.0   | 41.5   | 37.5             | 9,000        | 36,000,000                              | 73UW3120(1)00(2)           | R73UW3120(1)00(2)    |
| 2,000 | 500 | 0.15                   | 24.0             | 44.0   | 41.5   | 37.5             | 9,000        | 36,000,000                              | 73UW3150(1)00(2)           | R73UW3150(1)00(2)    |
| 2,000 | 500 | 0.18                   | 30.0             | 45.0   | 41.5   | 37.5             | 9,000        | 36,000,000                              | 73UW3180(1)00(2)           | R73UW3180(1)00(2)    |
| 2,000 | 500 | 0.22                   | 30.0             | 45.0   | 41.5   | 37.5             | 9,000        | 36,000,000                              | 73UW3220(1)00(2)           | R73UW3220(1)00(2)    |
| VDC   | VAC | Capacitance Value (µF) | B (mm)           | H (mm) | L (mm) | Lead Spacing (p) | dV/dt (V/µs) | Max K <sub>0</sub> (V <sup>2</sup> /µs) | KEMET Internal Part Number | Customer Part Number |

(1) Insert lead and packaging code. See Ordering Options Table for available options.

(2) H = ±2.5% (for 2-section construction only), J = ±5%, K = ±10%.

## Soldering Process

The implementation of the RoHS directive has resulted in the selection of SnAgCu (SAC) alloys or SnCu alloys as a primary solder. This has increased the liquidus temperature from that of 183°C for SnPb eutectic alloy to 217 – 221°C for the new alloys. As a result, the heat stress to the components, even in wave soldering, has increased considerably due to higher pre-heat and wave temperatures. Polypropylene capacitors are especially sensitive to heat (the melting point of polypropylene is 160 – 170°C). Wave soldering can be destructive, especially for mechanically small polypropylene capacitors (with lead spacing of 5 mm to 15 mm), and great care has to be taken during soldering. The recommended solder profiles from KEMET should be used. Please consult KEMET with any questions. In general, the wave soldering curve from IEC Publication 61760–1 Edition 2 serves as a solid guideline for successful soldering. Please see Figure 1.

Reflow soldering is not recommended for through-hole film capacitors. Exposing capacitors to a soldering profile in excess of the above recommended limits may result in degradation or permanent damage to the capacitors.

Do not place the polypropylene capacitor through an adhesive curing oven to cure resin for surface mount components. Insert through-hole parts after the curing of surface mount parts. Consult KEMET to discuss the actual temperature profile in the oven, if through-hole components must pass through the adhesive curing process. A maximum two soldering cycles is recommended. Please allow time for the capacitor surface temperature to return to a normal temperature before the second soldering cycle.

### Manual Soldering Recommendations

The following is recommended for manual soldering with a soldering iron.

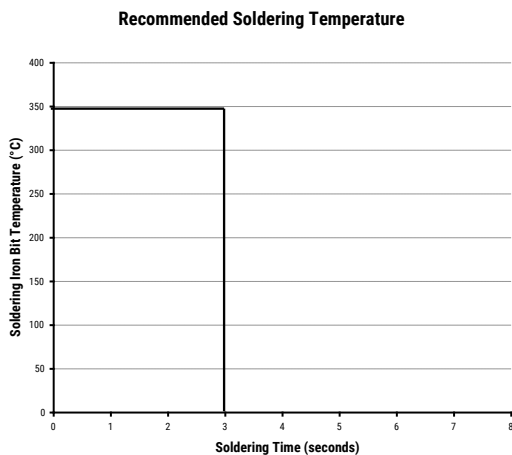

The soldering iron tip temperature should be set at 350°C (+10°C maximum) with the soldering duration not to exceed more than 3 seconds.

### Wave Soldering Recommendations

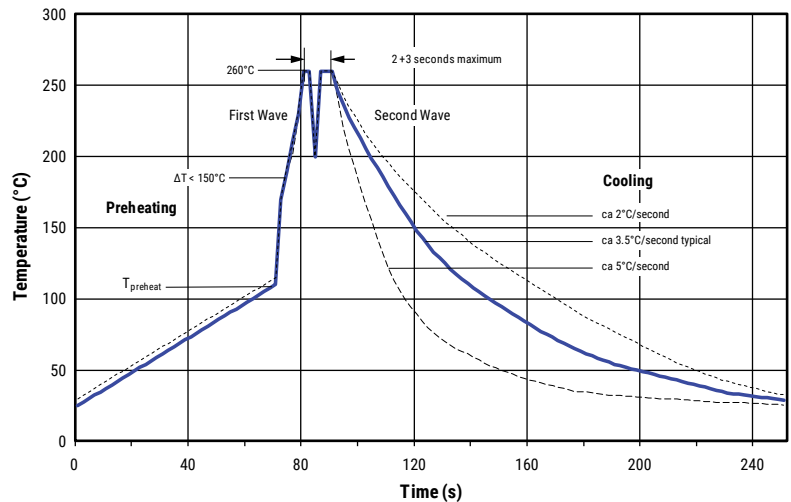



## Soldering Process cont.

### Wave Soldering Recommendations cont.

1. The table indicates the maximum set-up temperature of the soldering process  
Figure 1.

| Dielectric Film Material | Maximum Preheat Temperature |                         | Maximum Peak Soldering Temperature |                         |
|--------------------------|-----------------------------|-------------------------|------------------------------------|-------------------------|
|                          | Capacitor Pitch ≤ 15 mm     | Capacitor Pitch > 15 mm | Capacitor Pitch ≤ 15 mm            | Capacitor Pitch > 15 mm |
| Polyester                | 130°C                       | 130°C                   | 270°C                              | 270°C                   |
| Polypropylene            | 110°C                       | 130°C                   | 260°C                              | 270°C                   |
| Paper                    | 130°C                       | 140°C                   | 270°C                              | 270°C                   |
| Polyphenylene Sulphide   | 150°C                       | 160°C                   | 270°C                              | 270°C                   |

2. The maximum temperature measured inside the capacitor:

Set the temperature so that inside the element the maximum temperature is below the limit:

| Dielectric Film Material | Maximum temperature measured inside the element |
|--------------------------|---|
| Polyester                | 160°C   |
| Polypropylene            | 110°C   |
| Paper                    | 160°C   |
| Polyphenylene Sulphide   | 160°C   |

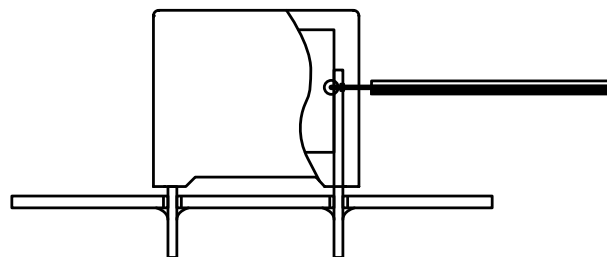

*Temperature monitored inside the capacitor.*

### Selective Soldering Recommendations

Selective dip soldering is a variation of reflow soldering. In this method, the printed circuit board with through-hole components to be soldered is preheated and transported over the solder bath as in normal flow soldering without touching the solder. When the board is over the bath, it is stopped and pre-designed solder pots are lifted from the bath with molten solder only at the places of the selected components, and pressed against the lower surface of the board to solder the components.

The temperature profile for selective soldering is similar to the double wave flow soldering outlined in this document, **however, instead of two baths, there is only one bath with a time from 3 to 10 seconds.** In selective soldering, the risk of overheating is greater than in double wave flow soldering. Great care must be taken so that the parts are not overheated.

## Construction

### 1 Section

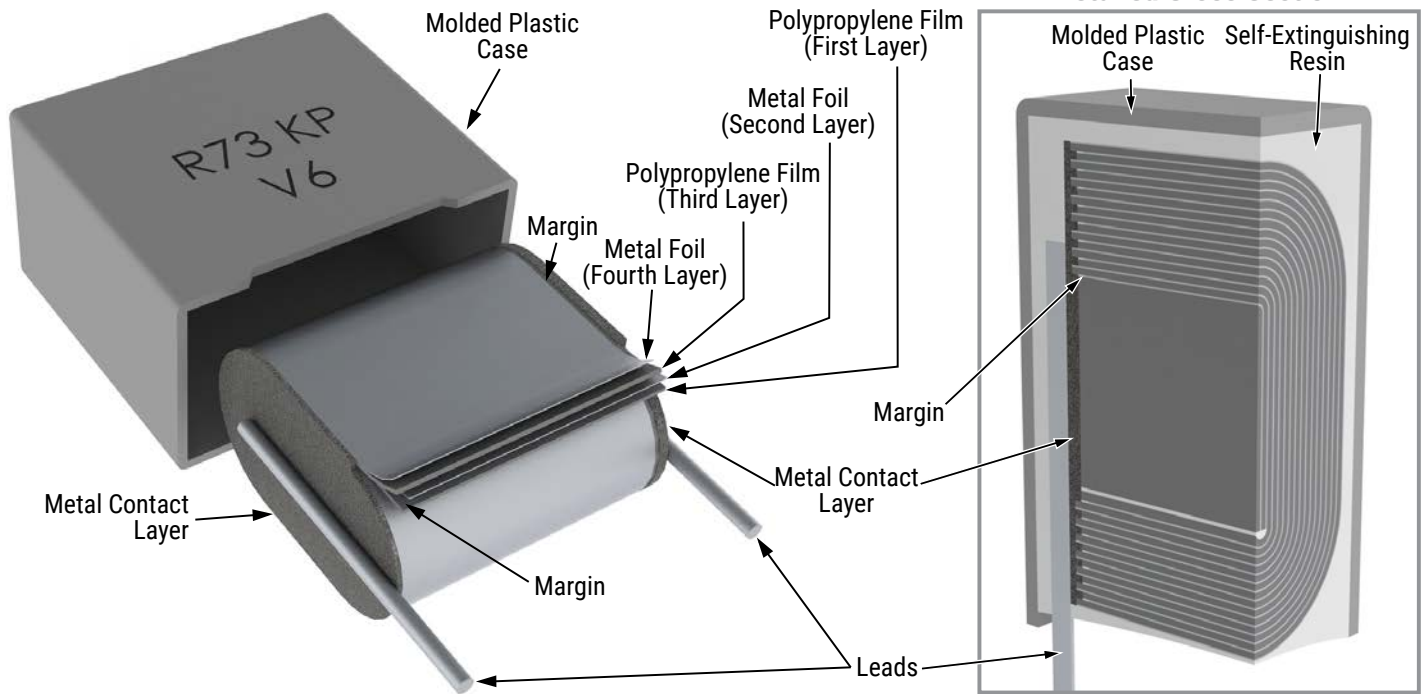

### Winding Schemes

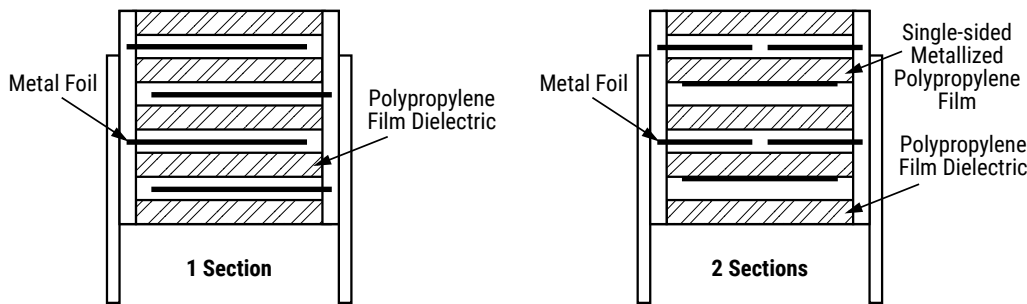

## Marking

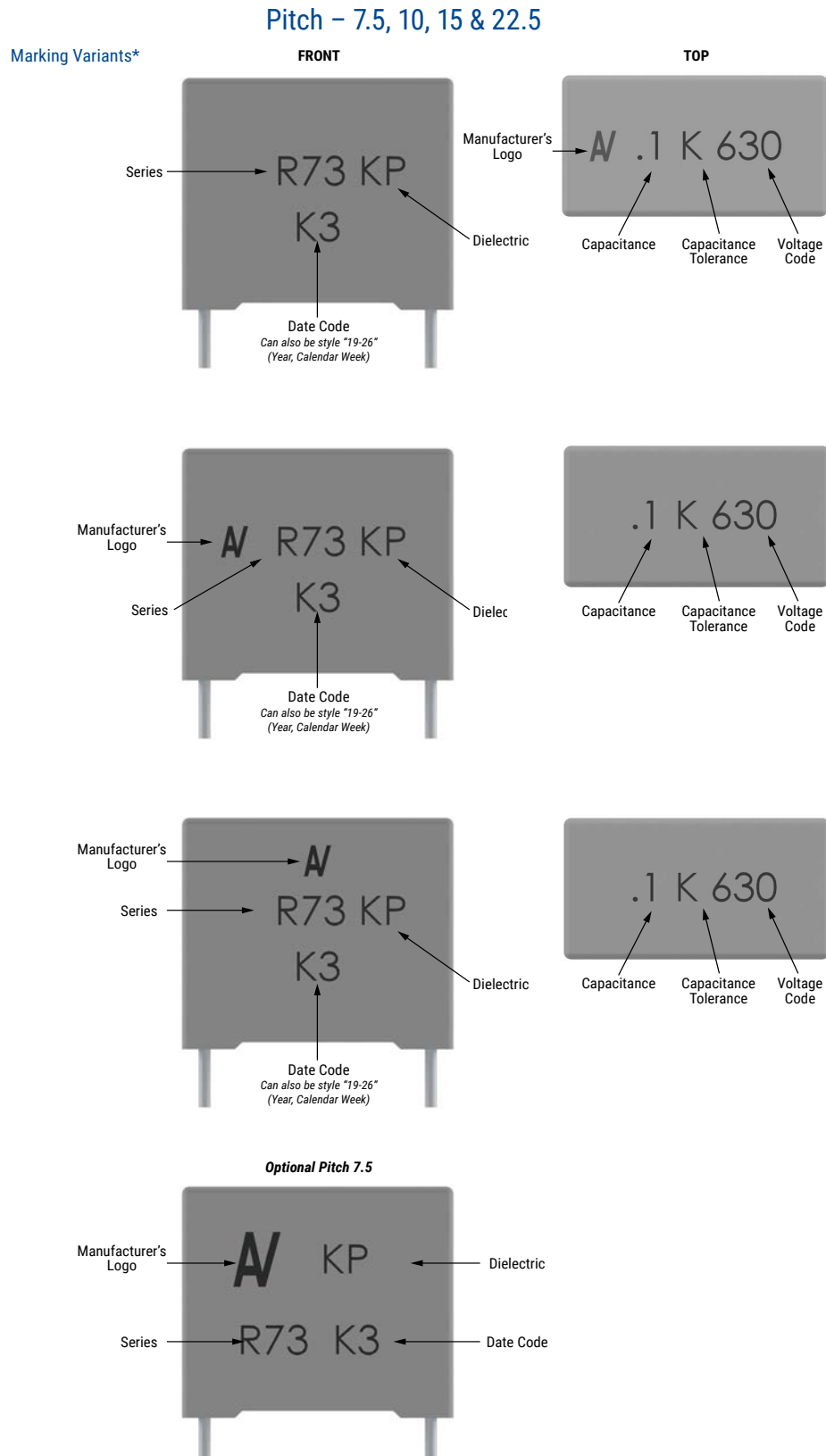

\* Differences are caused by technology (clichee, laser or ink jet) and technic (production line).

## Marking cont.

Pitch – 7.5, 10, 15, 22.5, 27.5 & 37.5

Marking Variants\*

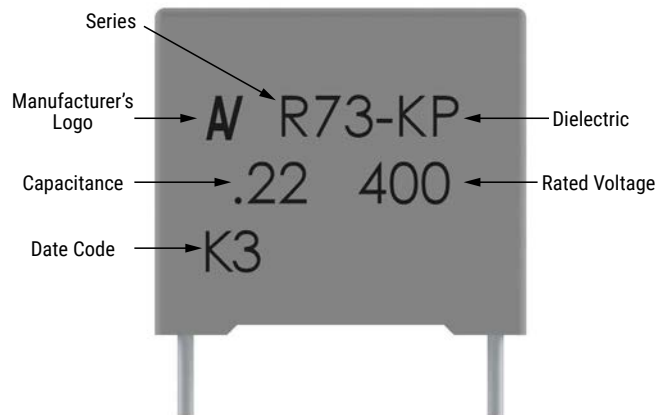
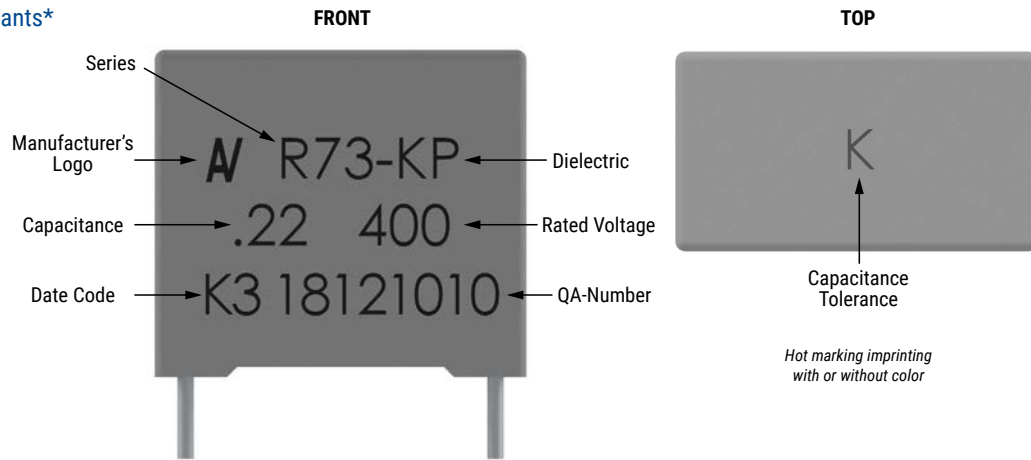

Pitch – 22.5, 27.5 & 37.5

Marking Variants\*

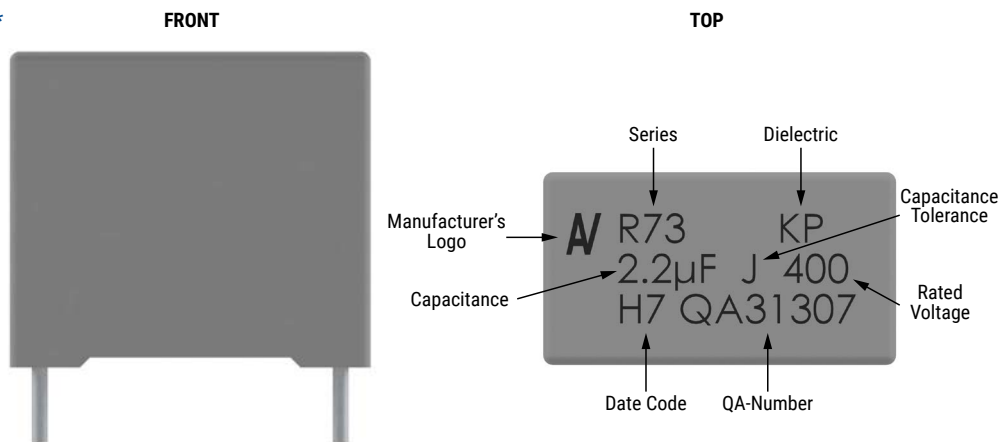

\* Differences are caused by technology (clichee, laser or ink jet) and technic (production line).

## Packaging Quantities

| Lead Spacing | Thickness (mm)          | Height (mm) | Length (mm) | Bulk Short Leads   | Bulk Long Leads |         | Standard Reel<br>ø 355 mm | Large Reel<br>ø 500 mm | Ammo Taped |
|--------------|-------------------------|-------------|-------------|--------------------|-----------------|---------|---------------------------|------------------------|------------|
|              | Lead and Packaging Code |             |             | JB - JE<br>JH - SE | JM              | 40 - 50 | GY                        | CK                     | DQ         |
| 10           | 4.0                     | 9.0         | 13.0        | 2,000              | 2,200           | 1,800   | 750                       | 1,500                  | 1,000      |
|              | 5.0                     | 11.0        | 13.0        | 1,300              | 2,000           | 1,500   | 600                       | 1,250                  | 800        |
|              | 6.0                     | 12.0        | 13.0        | 1,000              | 1,800           | 1,200   | 500                       | 1,000                  | 680        |
| 15           | 5.0                     | 11.0        | 18.0        | 2,000              | 1,250           | 1,000   | 600                       | 1,250                  | 800        |
|              | 6.0                     | 12.0        | 18.0        | 1,750              | 1,000           | 900     | 500                       | 1,000                  | 680        |
|              | 7.5                     | 13.5        | 18.0        | 1,000              | 800             | 700     | 350                       | 800                    | 500        |
|              | 8.5                     | 14.5        | 18.0        | 1,000              | 650             | 500     | 300                       | 700                    | 440        |
|              | 9.0                     | 12.5        | 18.0        | 1,000              | 700             | 520     | 270                       | 650                    | 410        |
|              | 10.0                    | 16.0        | 18.0        | 750                | 550             | 500     | 270                       | 600                    | 380        |
|              | 11.0                    | 19.0        | 18.0        | 450                | 400             | 350     | 270                       | 500                    | 340        |
|              | 13.0                    | 12.0        | 18.0        | 750                | 520             | 490     | 200                       | 480                    | 280        |
| 22.5         | 6.0                     | 15.0        | 26.5        | 805                | 450             | 500     | 300                       | 700                    | 464        |
|              | 7.0                     | 16.0        | 26.5        | 700                | 450             | 500     | 250                       | 550                    | 380        |
|              | 8.5                     | 17.0        | 26.5        | 468                | 350             | 300     | 250                       | 450                    | 280        |
|              | 10.0                    | 18.5        | 26.5        | 396                | 350             | 300     | 160                       | 350                    | 235        |
|              | 11.0                    | 20.0        | 26.5        | 360                | 200             | 250     | 190                       | 350                    | 217        |
|              | 13.0                    | 22.0        | 26.5        | 300                | 150             | 200     | 130                       | 300                    | -          |
| 27.5         | 9.0                     | 17.0        | 32.0        | 816                | -               | 408     | 230                       | 450                    | -          |
|              | 11.0                    | 20.0        | 32.0        | 560                | -               | 336     | 190                       | 350                    | -          |
|              | 13.0                    | 12.0        | 32.0        | 672                | -               | 288     | -                         | -                      | -          |
|              | 13.0                    | 22.0        | 32.0        | 480                | -               | 288     | 150                       | 300                    | -          |
|              | 13.0                    | 25.0        | 32.0        | 480                | -               | 288     | -                         | 300                    | -          |
|              | 14.0                    | 28.0        | 32.0        | 352                | -               | 176     | -                         | -                      | -          |
|              | 18.0                    | 33.0        | 32.0        | 256                | -               | 128     | -                         | -                      | -          |
|              | 22.0                    | 37.0        | 32.0        | 168                | -               | 112     | -                         | -                      | -          |
|              | 24.0                    | 15.0        | 32.0        | 336                | -               | 144     | -                         | -                      | -          |
| 37.5         | 11.0                    | 22.0        | 41.5        | 420                | -               | 252     | -                         | -                      | -          |
|              | 13.0                    | 24.0        | 41.5        | 360                | -               | 216     | -                         | -                      | -          |
|              | 16.0                    | 28.5        | 41.5        | 216                | -               | 108     | -                         | -                      | -          |
|              | 19.0                    | 32.0        | 41.5        | 192                | -               | 96      | -                         | -                      | -          |
|              | 20.0                    | 40.0        | 41.5        | 126                | -               | 84      | -                         | -                      | -          |
|              | 24.0                    | 15.0        | 41.5        | 252                | -               | 108     | -                         | -                      | -          |
|              | 24.0                    | 19.0        | 41.5        | 216                | -               | 108     | -                         | -                      | -          |
|              | 24.0                    | 44.0        | 41.5        | 108                | -               | 72      | -                         | -                      | -          |
|              | 30.0                    | 45.0        | 41.5        | 90                 | -               | 60      | -                         | -                      | -          |

## Lead Taping & Packaging (IEC 60286-2)

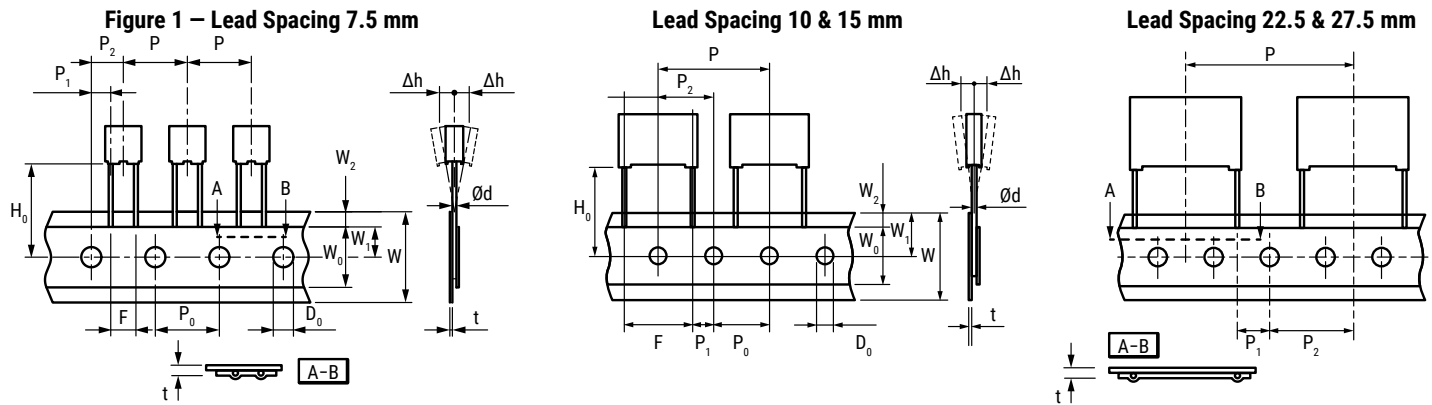

## Taping Specification

| Description                          | Symbol              | Dimensions (mm) |                  |                  |                  |                  | Tolerance |
|--------------------------------------|---------------------|-----------------|------------------|------------------|------------------|------------------|-----------|
|                                      |                     | Lead Spacing    |                  |                  |                  |                  |           |
|                                      |                     | 7.5<br>Figure 1 | 10.0<br>Figure 2 | 15.0<br>Figure 2 | 22.5<br>Figure 3 | 27.5<br>Figure 3 |           |
| Lead wire diameter                   | d                   | 0.5 – 0.6       | 0.6              | 0.6 – 0.8        | 0.8              | 0.8              | ±0.05     |
| Taping lead space                    | P                   | 12.7            | 25.4             | 25.4             | 38.1             | 38.1             | ±1        |
| Feed hole lead space *               | P <sub>0</sub>      | 12.7            | 12.7             | 12.7             | 12.7             | 12.7             | ±0.2 **   |
| Centering of the lead wire           | P <sub>1</sub>      | 2.6             | 7.7              | 5.2              | 7.8              | 5.3              | ±0.7      |
| Centering of the body                | P <sub>2</sub>      | 6.35            | 12.7             | 12.7             | 19.05            | 19.05            | ±1.3      |
| Lead spacing ***                     | F                   | 7.5             | 10.0             | 15.0             | 22.5             | 27.5             | +0.6/-0.1 |
| Component alignment                  | Δh                  | 0               | 0                | 0                | 0                | 0                | ±2        |
| Component deviation                  | Δp                  | 0               | 0                | 0                | 0                | 0                | ±1        |
| Height of component from tape center | H <sub>0</sub> **** | 18.5            | 18.5             | 18.5             | 18.5             | 18.5             | ±0.5      |
| Carrier tape width                   | W                   | 18              | 18               | 18               | 18               | 18               | +1/-0.5   |
| Hold down tape width                 | W <sub>0</sub>      | 6               | 9                | 10               | 10               | 10               | Minimum   |
| Hole position                        | W <sub>1</sub>      | 9               | 9                | 9                | 9                | 9                | ±0.5      |
| Hold down tape position              | W <sub>2</sub>      | 3               | 3                | 3                | 3                | 3                | Maximum   |
| Feed hole diameter                   | D <sub>0</sub>      | 4               | 4                | 4                | 4                | 4                | ±0.2      |
| Total tape thickness                 | t                   | 0.7             | 0.7              | 0.7              | 0.7              | 0.7              | ±0.2      |

\* Available also 15 mm.

\*\* Maximum 1 mm on 20 lead spacing.

\*\*\* 15 mm and 10 mm taped to 7.5 mm (crimped leads) available upon request.

\*\*\*\* H<sub>0</sub> = 16.5 mm is available upon request.

## Lead Taping & Packaging (IEC 60286-2) cont.

### Ammo Specifications

| Dimensions (mm) |     |    |
|-----------------|-----|----|
| H               | W   | T  |
| 360             | 340 | 59 |

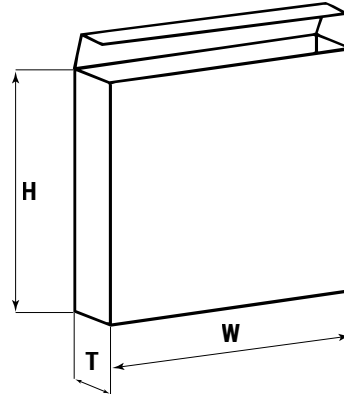

### Reel Specifications

| Dimensions (mm) |    |            |
|-----------------|----|------------|
| D               | H  | W          |
| 355             | 30 | 55 Maximum |
| 500             | 25 |            |

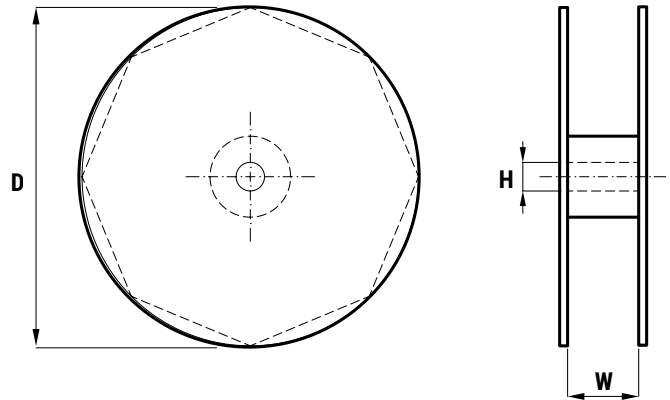

### Manufacturing Date Code (IEC-60062)

| Y = Year, Z = Month |      |           |      |
|---------------------|------|-----------|------|
| Year                | Code | Month     | Code |
| 2010                | A    | January   | 1    |
| 2011                | B    | February  | 2    |
| 2012                | C    | March     | 3    |
| 2013                | D    | April     | 4    |
| 2014                | E    | May       | 5    |
| 2015                | F    | June      | 6    |
| 2016                | H    | July      | 7    |
| 2017                | J    | August    | 8    |
| 2018                | K    | September | 9    |
| 2019                | L    | October   | 0    |
| 2020                | M    | November  | N    |
| 2021                | N    | December  | D    |
| 2022                | P    |           |      |
| 2023                | R    |           |      |
| 2024                | S    |           |      |
| 2025                | T    |           |      |
| 2026                | U    |           |      |
| 2027                | V    |           |      |
| 2028                | W    |           |      |
| 2029                | X    |           |      |
| 2030                | A    |           |      |

## KEMET Electronics Corporation Sales Offices

For a complete list of our global sales offices, please visit [www.kemet.com/sales](http://www.kemet.com/sales).

---

### Disclaimer

All product specifications, statements, information and data (collectively, the "Information") in this datasheet are subject to change. The customer is responsible for checking and verifying the extent to which the Information contained in this publication is applicable to an order at the time the order is placed. All Information given herein is believed to be accurate and reliable, but it is presented without guarantee, warranty, or responsibility of any kind, expressed or implied.

Statements of suitability for certain applications are based on KEMET Electronics Corporation's ("KEMET") knowledge of typical operating conditions for such applications, but are not intended to constitute – and KEMET specifically disclaims – any warranty concerning suitability for a specific customer application or use. The Information is intended for use only by customers who have the requisite experience and capability to determine the correct products for their application. Any technical advice inferred from this Information or otherwise provided by KEMET with reference to the use of KEMET's products is given gratis, and KEMET assumes no obligation or liability for the advice given or results obtained.

Although KEMET designs and manufactures its products to the most stringent quality and safety standards, given the current state of the art, isolated component failures may still occur. Accordingly, customer applications which require a high degree of reliability or safety should employ suitable designs or other safeguards (such as installation of protective circuitry or redundancies) in order to ensure that the failure of an electrical component does not result in a risk of personal injury or property damage.

Although all product-related warnings, cautions and notes must be observed, the customer should not assume that all safety measures are indicated or that other measures may not be required.

*KEMET is a registered trademark of KEMET Electronics Corporation.*



单击下面可查看定价，库存，交付和生命周期等信息

[>>KEMET\(基美\)](#)