

R41, Class Y2, 300 VAC, 110°C (Automotive Grade)

Overview

The R41 is constructed of metallized polypropylene film encapsulated with self-extinguishing resin in a box of material meeting the requirements of UL 94 V-0.

Automotive Grade devices (up to 22.5 mm Lead Spacing) meet the demanding Automotive Electronics Council's AEC-Q200 qualification requirements.

Applications

For use in electromagnetic interference (EMI) suppression filter in "line-to-ground" and "across-the-line" applications requiring Y2/X1 safety classification. Suitable for use in situations where failure of the capacitor could lead to danger of electric shock. Not for use in "series with mains" type applications.

Benefits

- Approvals: ENEC, UL, cUL, CQC
- Class Y2 / X1 (IEC 60384-14)
- Rated voltage: 300 VAC 50/60 Hz
- Capacitance range: 0.001 – 1 μ F
- Lead spacing: 10 – 37.5 mm
- Capacitance tolerance: \pm 20%, \pm 10%
- Climatic category: 40/110/56, IEC 60068-1
- Tape and reel in accordance with IEC 60286-2
- RoHS Compliant and lead-free terminations
- Operating temperature range of -40°C to $+110^{\circ}\text{C}$
- 100% screening factory test at 5,000 VDC/2,500 VAC
- Self-healing properties
- Automotive (AEC-Q200) grades available up to 22.5 mm Lead Spacing

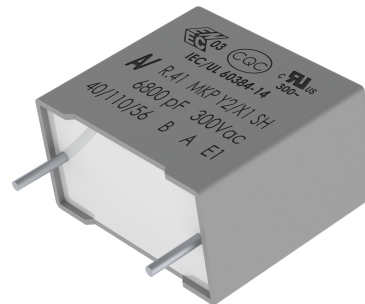

Part Number System

| R41 | 3 | I | 2330 | 00 | M1 | M |
|------------------------------|---------------------|--|--|----------------------------|--------------|--------------------------------|
| Series | Rated Voltage (VAC) | Lead Spacing (mm) | Capacitance Code (pF) | Packaging | Internal Use | Capacitance Tolerance |
| Y2, Metallized Polypropylene | 3 = 300 | F = 10.0 I = 15.0 N = 22.5 R = 27.5 W = 37.5 | The last three digits represent significant figures. The first digit specifies number of zeros to be added. | See Ordering Options Table | 00 M1 | K = \pm 10% M = \pm 20% |

Ordering Options Table

| Lead Spacing Nominal (mm) | Type of Leads and Packaging | Lead Length (mm) | Lead and Packaging Code |
|---------------------------|--|----------------------------|-------------------------|
| 10, 15, 22.5 | Standard Lead and Packaging Options | | |
| | Bulk (Bag) – Short Leads | 4 +2/-0 | 00 |
| | Ammo Pack | H ₀ = 18.5 ±0.5 | DQ |
| | Other Lead and Packaging Options | | |
| | Tape & Reel (Large Reel) | H ₀ = 18.5 ±0.5 | CK |
| | Bulk (Bag) – Short Leads | 3.5 +0.5/-0 | JB |
| | Bulk (Bag) – Short Leads | 4.0 +0.5/-0 | JE |
| | Bulk (Bag) – Short Leads | 3.2 +0.3/-0.2 | JH |
| | Bulk (Bag) – Long Leads | 18 ±1 | JM |
| | Bulk (Bag) – Long Leads | 30 +5/-0 | 40 |
| Bulk (Bag) – Long Leads | 25 +2/-1 | 50 | |
| 27.5 | Standard Lead and Packaging Options | | |
| | Bulk (Bag) – Short Leads | 4 +2/-0 | 00 |
| | Tape & Reel (Large Reel) | H ₀ = 18.5 ±0.5 | CK |
| | Other Lead and Packaging Options | | |
| | Bulk (Bag) – Long Leads | 30 +5/-0 | 40 |
| | Bulk (Bag) – Long Leads | 25 +2/-1 | 50 |
| 37.5 | Standard Lead and Packaging Options | | |
| | Bulk (Bag) – Short Leads | 4 +2/-0 | 00 |
| | Other Lead and Packaging Options | | |
| | Bulk (Bag) – Long Leads | 30 +5/-0 | 40 |
| Bulk (Bag) – Long Leads | 25 +2/-1 | 50 | |

Dimensions – Millimeters

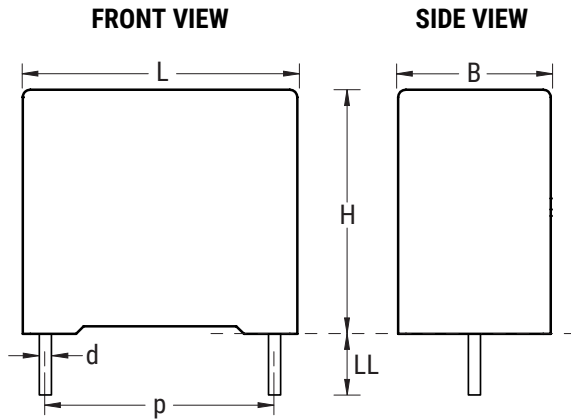

| p | | B | | H | | L | | d | |
|---------|-----------|---------|-----------|---------|-----------|---------|-----------|---------|-----------|
| Nominal | Tolerance | Nominal | Tolerance | Nominal | Tolerance | Nominal | Tolerance | Nominal | Tolerance |
| 10.0 | ±0.4 | 4.0 | +0.2 | 9.0 | +0.1 | 13.0 | +0.2 | 0.6 | ±0.05 |
| 10.0 | ±0.4 | 5.0 | +0.2 | 11.0 | +0.1 | 13.0 | +0.2 | 0.6 | ±0.05 |
| 10.0 | ±0.4 | 6.0 | +0.2 | 12.0 | +0.1 | 13.0 | +0.2 | 0.6 | ±0.05 |
| 15.0 | ±0.4 | 5.0 | +0.2 | 11.0 | +0.1 | 18.0 | +0.3 | 0.6 | ±0.05 |
| 15.0 | ±0.4 | 6.0 | +0.2 | 12.0 | +0.1 | 18.0 | +0.3 | 0.6 | ±0.05 |
| 15.0 | ±0.4 | 7.5 | +0.2 | 13.5 | +0.1 | 18.0 | +0.5 | 0.6 | ±0.05 |
| 15.0 | ±0.4 | 8.5 | +0.2 | 14.5 | +0.1 | 18.0 | +0.5 | 0.6 | ±0.05 |
| 15.0 | ±0.4 | 11.0 | +0.2 | 19.0 | +0.1 | 18.0 | +0.5 | 0.8 | ±0.05 |
| 22.5 | ±0.4 | 6.0 | +0.2 | 15.0 | +0.1 | 26.5 | +0.3 | 0.8 | ±0.05 |
| 22.5 | ±0.4 | 7.0 | +0.2 | 16.0 | +0.1 | 26.5 | +0.3 | 0.8 | ±0.05 |
| 22.5 | ±0.4 | 8.5 | +0.2 | 17.0 | +0.1 | 26.5 | +0.3 | 0.8 | ±0.05 |
| 22.5 | ±0.4 | 10.0 | +0.2 | 18.5 | +0.1 | 26.5 | +0.3 | 0.8 | ±0.05 |
| 22.5 | ±0.4 | 13.0 | +0.2 | 22.0 | +0.1 | 26.5 | +0.3 | 0.8 | ±0.05 |
| 27.5 | ±0.4 | 13.0 | +0.2 | 22.0 | +0.1 | 32.0 | +0.3 | 0.8 | ±0.05 |
| 27.5 | ±0.4 | 14.0 | +0.2 | 28.0 | +0.1 | 32.0 | +0.3 | 0.8 | ±0.05 |
| 27.5 | ±0.4 | 18.0 | +0.2 | 33.0 | +0.1 | 32.0 | +0.3 | 0.8 | ±0.05 |
| 37.5 | ±0.4 | 13.0 | +0.3 | 24.0 | +0.1 | 41.5 | +0.3 | 1.0 | ±0.05 |
| 37.5 | ±0.4 | 16.0 | +0.3 | 28.5 | +0.1 | 41.5 | +0.3 | 1.0 | ±0.05 |
| 37.5 | ±0.4 | 20.0 | +0.3 | 40.0 | +0.1 | 41.5 | +0.3 | 1.0 | ±0.05 |

Note: See Ordering Options Table for lead length (LL/H₀) options.

Performance Characteristics

| | |
|-------------------------|--|
| Dielectric | Polypropylene film |
| Plates | Metal layer deposited by evaporation under vacuum |
| Winding | Non-inductive type |
| Leads | Tinned wire |
| Protection | Plastic case, thermosetting resin filled. Box material is solvent resistant and flame retardant according to UL94. |
| Related documents | IEC 60384-14, EN 60384-14 |
| Rated Voltage (V_R) | 300 VAC (50/60 Hz), 1,000 VDC |
| Capacitance Range | 0.0010 to 1 μ F |
| Capacitance Values | E6 series (IEC 60063) |
| Capacitance Tolerance | $\pm 10\%$, $\pm 20\%$ |
| Temperature Range | -40°C to +110°C |
| Climatic Category | 40/110/56 IEC 60068-1 |
| Storage Conditions | Storage time: ≤ 24 months from the date marked on the label package |
| | Average relative humidity per year $\leq 70\%$ |
| | RH $\leq 85\%$ for 30 days randomly distributed throughout the year |
| | Dew is absent |
| | Temperature: -40 to 80°C (see "Maximum Humidity in Storage Conditions" graph below) |
| Approvals | ENEC, UL, cUL, CQC |

Maximum Humidity in Storage Conditions

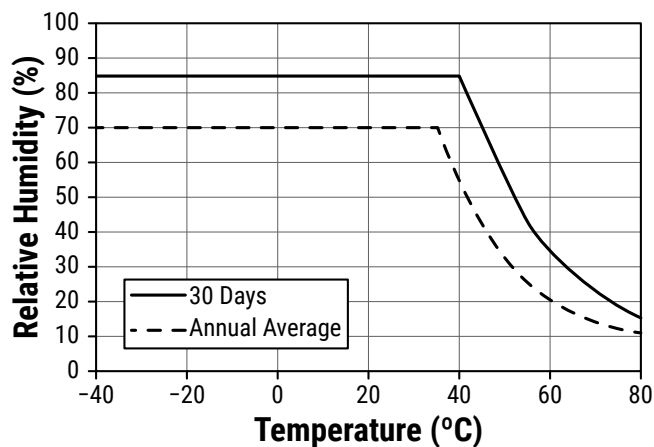

Performance Characteristics cont'd

| | | | | |
|-------------------------------------|--|---------------------|---|--|
| Dissipation Factor ($\tan\delta$) | $\leq 0.3\%$ (0.2%*) at 1kHz, +25°C \pm 5°C (* typical value) | | | |
| Test Voltage Between Terminals | The 100% screening factory test is carried out at 5,000 VDC/2,500 VAC. The voltage level is selected to meet the requirements in applicable equipment standards. All electrical characteristics are checked after the test. It is not permitted to repeat this test as there is a risk to damage the capacitor. KEMET is not liable in such case for any failures. | | | |
| Insulation Resistance | Measured at +25°C \pm 5°C, according to IEC 60384-2 | | | |
| | Minimum Values Between Terminals | | | |
| | Voltage Charge | Voltage Charge Time | $C \leq 0.33 \mu\text{F}$ | $C > 0.33 \mu\text{F}$ |
| | 100 VDC | 1 min | $\geq 1 \cdot 10^5 \text{ M}\Omega$ ($\geq 5 \cdot 10^5 \text{ M}\Omega$)* | $\geq 30,000 \text{ M}\Omega \cdot \mu\text{F}$ ($\geq 150,000 \text{ M}\Omega \cdot \mu\text{F}$)* |
| In DC Applications | Recommended voltage $\leq 1,000$ VDC | | | |

* Typical value

Qualification

Automotive grade products meet or exceed the requirements outlined by the Automotive Electronics Council. Details regarding test methods and conditions are referenced in document AEC-Q200, Stress Test Qualification for Passive Components. For additional information regarding the Automotive Electronics Council and AEC-Q200, please visit their website at www.aecouncil.com.

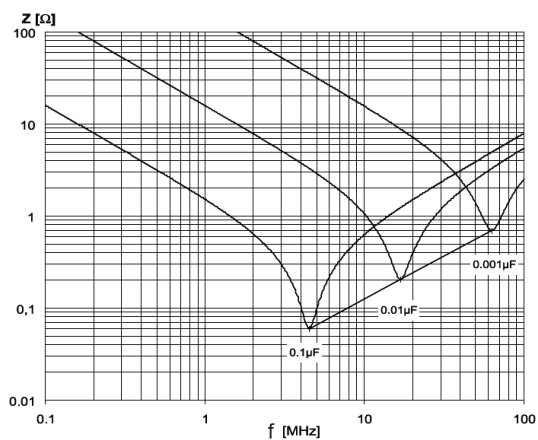

Impedance Graph



Environmental Test Data

| Test | IEC Publication | Procedure |
|------------------------|-------------------------|--|
| Endurance | EN/IEC 60384-14 | 1.7 x V _R VAC 50 Hz, once every hour increase to 1,000 VAC for 0.1 second, 1,000 hours at upper rated temperature |
| Vibration | IEC 60068-2-6 Test Fc | 3 directions at 2 hours each 10 – 55 Hz at 0.75 mm or 98 m/s ² |
| Bump | IEC 60068-2-29 Test Eb | 1,000 bumps at 390 m/s ² |
| Change of Temperature | IEC 60068-2-14 Test Na | Upper and lower rated temperature 5 cycles |
| Active Flammability | IEC 60384-14 | V _R +20 surge pulses at 5 kV (pulse every 5 seconds) |
| Passive Flammability | IEC 60384-14 | IEC 60384-1, IEC 60695-11-5 Needle flame test |
| Damp Heat Steady State | IEC 60068-2-78 Test Cab | +40°C and 93% RH, 56 days |

Approvals

| Mark | Specification | File Number |
|---|---|--|
|  | EN/IEC 60384-14 | V4160 |
|  | UL 60384-14 and CAN/CSA E60384-14 (300 VAC) | E97797 |
|  | IEC 60384-14 | CQC13001087758 CQC13001101264 CQC14001116018 CQC14001116611 |

Environmental Compliance

All KEMET EMI capacitors are RoHS Compliant.

Table 1 – Ratings & Part Number Reference

| Capacitance Value (µF) | Dimensions in mm | | | Lead Spacing (p) | dV/dt (V/µs) | New KEMET Part Number | Legacy Part Number |
|------------------------|------------------|-------------|-------------|------------------|--------------|-------------------------|--------------------------|
| | B | H | L | | | | |
| 0.0010 | 4.0 | 9.0 | 13.0 | 10.0 | 800 | 413F1100(1)00(2) | R413F1100(1)00(2) |
| 0.0015 | 4.0 | 9.0 | 13.0 | 10.0 | 800 | 413F1150(1)00(2) | R413F1150(1)00(2) |
| 0.0022 | 4.0 | 9.0 | 13.0 | 10.0 | 800 | 413F1220(1)00(2) | R413F1220(1)00(2) |
| 0.0033 | 4.0 | 9.0 | 13.0 | 10.0 | 800 | 413F1330(1)M1(2) | R413F1330(1)M1(2) |
| 0.0047 | 5.0 | 11.0 | 13.0 | 10.0 | 800 | 413F1470(1)M1(2) | R413F1470(1)M1(2) |
| 0.0068 | 6.0 | 12.0 | 13.0 | 10.0 | 800 | 413F1680(1)00(3) | R413F1680(1)00(3) |
| 0.010 | 6.0 | 12.0 | 13.0 | 10.0 | 800 | 413F2100(1)M1(3) | R413F2100(1)M1(3) |
| 0.0033 | 5.0 | 11.0 | 18.0 | 15.0 | 600 | 413I1330(1)00(2) | R413I1330(1)00(2) |
| 0.0047 | 5.0 | 11.0 | 18.0 | 15.0 | 600 | 413I1470(1)00(2) | R413I1470(1)00(2) |
| 0.0068 | 5.0 | 11.0 | 18.0 | 15.0 | 600 | 413I1680(1)00(2) | R413I1680(1)00(2) |
| 0.010 | 5.0 | 11.0 | 18.0 | 15.0 | 600 | 413I2100(1)00(2) | R413I2100(1)00(2) |
| 0.015 | 5.0 | 11.0 | 18.0 | 15.0 | 600 | 413I2150(1)M1(2) | R413I2150(1)M1(2) |
| 0.022 | 6.0 | 12.0 | 18.0 | 15.0 | 600 | 413I2220(1)M1(2) | R413I2220(1)M1(2) |
| 0.033 | 7.5 | 13.5 | 18.0 | 15.0 | 600 | 413I2330(1)M1(2) | R413I2330(1)M1(2) |
| 0.047 | 8.5 | 14.5 | 18.0 | 15.0 | 600 | 413I2470(1)M1(2) | R413I2470(1)M1(2) |
| 0.068 | 11.0 | 19.0 | 18.0 | 15.0 | 600 | 413I2680(1)00(2) | R413I2680(1)00(2) |
| 0.047 | 6.0 | 15.0 | 26.5 | 22.5 | 500 | 413N2470(1)00(2) | R413N2470(1)00(2) |
| 0.068 | 6.0 | 15.0 | 26.5 | 22.5 | 500 | 413N2680(1)M1(3) | R413N2680(1)M1(3) |
| 0.068 | 7.0 | 16.0 | 26.5 | 22.5 | 500 | 413N2680(1)00(2) | R413N2680(1)00(2) |
| 0.10 | 8.5 | 17.0 | 26.5 | 22.5 | 500 | 413N3100(1)M1(2) | R413N3100(1)M1(2) |
| 0.15 | 10.0 | 18.5 | 26.5 | 22.5 | 500 | 413N3150(1)M1(2) | R413N3150(1)M1(2) |
| 0.22 | 13.0 | 22.0 | 26.5 | 22.5 | 500 | 413N3220(1)00(2) | R413N3220(1)00(2) |
| 0.22 | 13.0 | 22.0 | 32.0 | 27.5 | 400 | 413R3220(1)00(2) | R413R3220(1)00(2) |
| 0.33 | 14.0 | 28.0 | 32.0 | 27.5 | 400 | 413R3330(1)00(2) | R413R3330(1)00(2) |
| 0.47 | 18.0 | 33.0 | 32.0 | 27.5 | 400 | 413R3470(1)00(2) | R413R3470(1)00(2) |
| 0.68 | 18.0 | 33.0 | 32.0 | 27.5 | 400 | 413R3680(1)00(2) | R413R3680(1)00(2) |
| 0.47 | 13.0 | 24.0 | 41.5 | 37.5 | 300 | 413W 3470(1)00(2) | R413W 3470(1)00(2) |
| 0.68 | 16.0 | 28.5 | 41.5 | 37.5 | 300 | 413W 3680(1)00(2) | R413W 3680(1)00(2) |
| 1.0 | 20.0 | 40.0 | 41.5 | 37.5 | 300 | 413W 4100(1)00(2) | R413W 4100(1)00(2) |
| Capacitance Value (µF) | B (mm) | H (mm) | L (mm) | Lead Spacing (p) | dV/dt (V/µs) | New KEMET Part Number | Legacy Part Number |

(1) Insert lead and packaging code. See Ordering Options Table for available options.

(2) M = ±20%, K = ±10%

(3) M = ±20% (only available tolerance).

Soldering Process

The implementation of the RoHS directive has resulted in the selection of SnAgCu (SAC) alloys or SnCu alloys as primary solder. This has increased the liquidus temperature from that of 183°C for SnPb eutectic alloy to 217 – 221°C for the new alloys. As a result, the heat stress to the components, even in wave soldering, has increased considerably due to higher pre-heat and wave temperatures. Polypropylene capacitors are especially sensitive to heat (the melting point of polypropylene is 160 – 170°C). Wave soldering can be destructive, especially for mechanically small polypropylene capacitors (with lead spacing of 5 mm to 15 mm), and great care has to be taken during soldering. The recommended solder profiles from KEMET should be used. Please consult KEMET with any questions. In general, the wave soldering curve from IEC Publication 61760-1 Edition 2 serves as a solid guideline for successful soldering. Please see Figure 1.

Reflow soldering is not recommended for through-hole film capacitors. Exposing capacitors to a soldering profile in excess of the above the recommended limits may result to degradation or permanent damage to the capacitors.

Do not place the polypropylene capacitor through an adhesive curing oven to cure resin for surface mount components. Insert through-hole parts after the curing of surface mount parts. Consult KEMET to discuss the actual temperature profile in the oven, if through-hole components must pass through the adhesive curing process. A maximum two soldering cycles is recommended. Please allow time for the capacitor surface temperature to return to a normal temperature before the second soldering cycle.

Manual Soldering Recommendations

The following is the recommendation for manual soldering with a soldering iron.

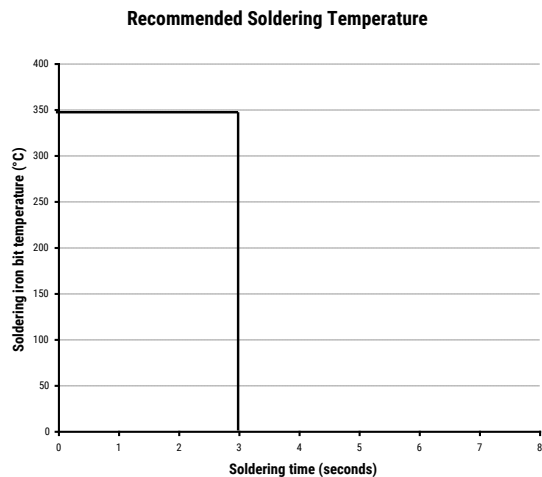

The soldering iron tip temperature should be set at 350°C (+10°C maximum) with the soldering duration not to exceed more than 3 seconds.

Wave Soldering Recommendations

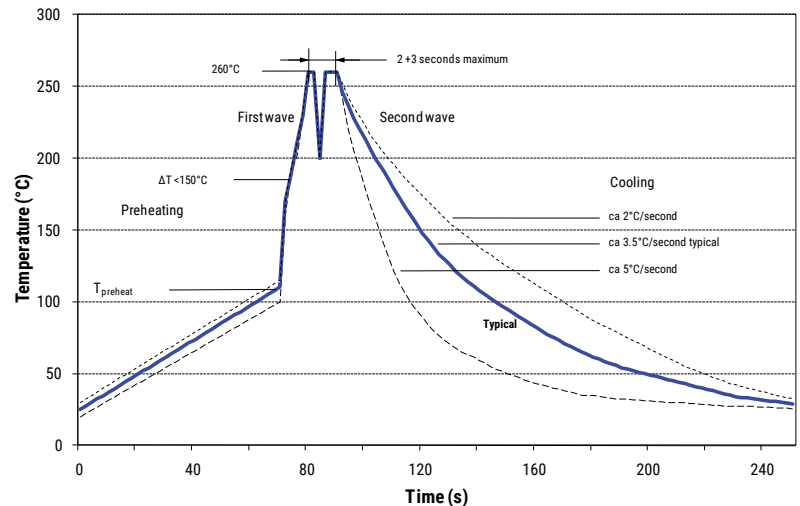

Soldering Process cont'd

Wave Soldering Recommendations cont'd

1. The table indicates the maximum set-up temperature of the soldering process
Figure 1

| Dielectric Film Material | Maximum Preheat Temperature | | | Maximum Peak Soldering Temperature | |
|--------------------------|-----------------------------|-------------------------|-------------------------|------------------------------------|-------------------------|
| | Capacitor Pitch ≤ 10 mm | Capacitor Pitch = 15 mm | Capacitor Pitch > 15 mm | Capacitor Pitch ≤ 15 mm | Capacitor Pitch > 15 mm |
| Polyester | 130°C | 130°C | 130°C | 270°C | 270°C |
| Polypropylene | 100°C | 110°C | 130°C | 260°C | 270°C |
| Paper | 130°C | 130°C | 140°C | 270°C | 270°C |
| Polyphenylene Sulphide | 150°C | 150°C | 160°C | 270°C | 270°C |

2. The maximum temperature measured inside the capacitor:

Set the temperature so that inside the element the maximum temperature is below the limit:

| Dielectric Film Material | Maximum temperature measured inside the element |
|--------------------------|---|
| Polyester | 160°C |
| Polypropylene | 110°C |
| Paper | 160°C |
| Polyphenylene sulphide | 160°C |

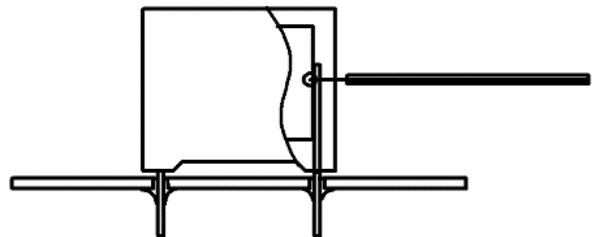

Temperature monitored inside the capacitor.

Selective Soldering Recommendations

Selective dip soldering is a variation of reflow soldering. In this method, the printed circuit board with through-hole components to be soldered is preheated and transported over the solder bath as in normal flow soldering without touching the solder. When the board is over the bath, it is stopped and pre-designed solder pots are lifted from the bath with molten solder only at the places of the selected components, and pressed against the lower surface of the board to solder the components.

The temperature profile for selective soldering is similar to the double wave flow soldering outlined in this document, **however, instead of two baths, there is only one bath with a time from 3 to 10 seconds.** In selective soldering, the risk of overheating is greater than in double wave flow soldering, and great care must be taken so that the parts are not overheated.

Construction

2 Sections

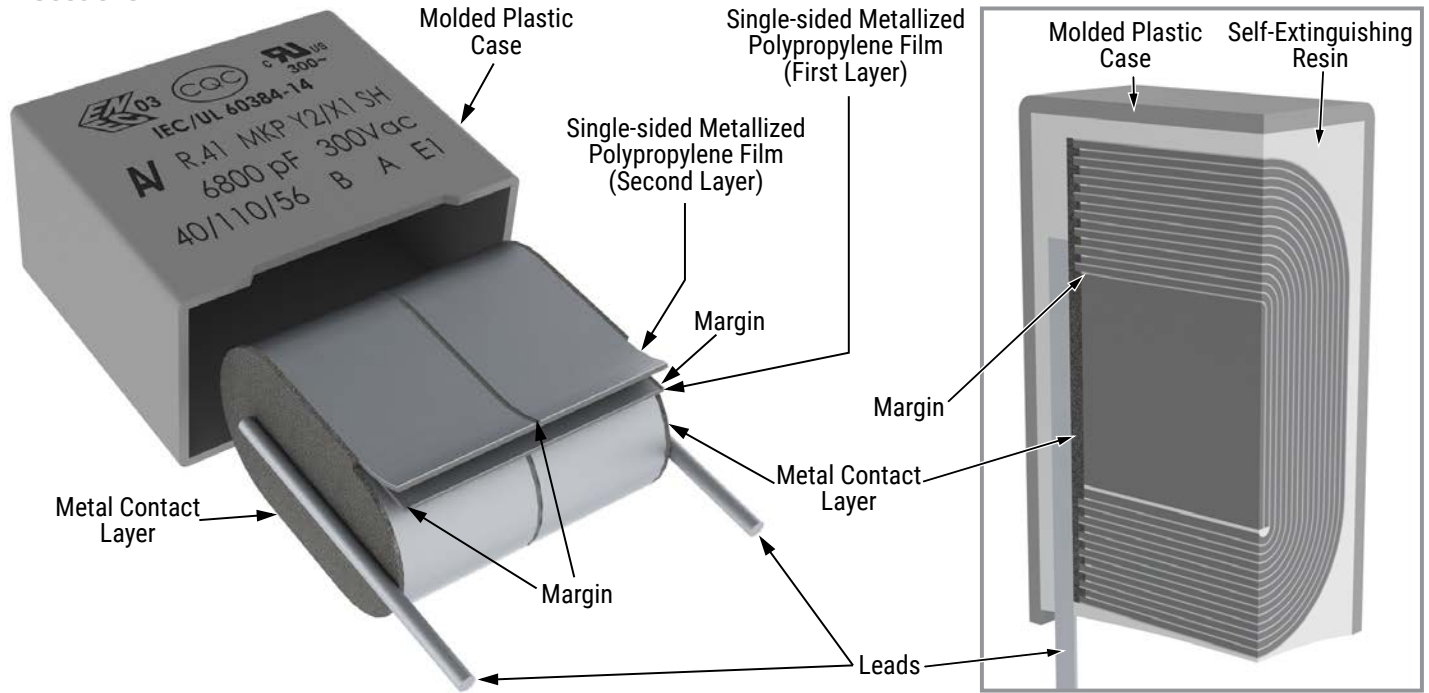

Winding Scheme

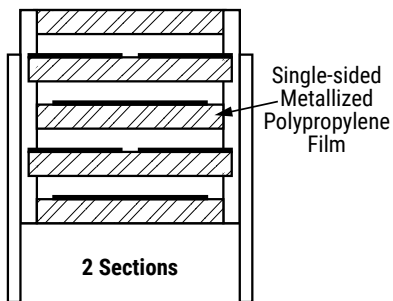

Marking

Lead Spacing 10 mm

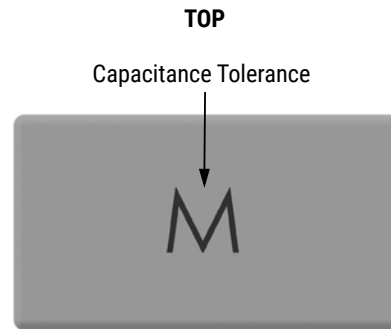
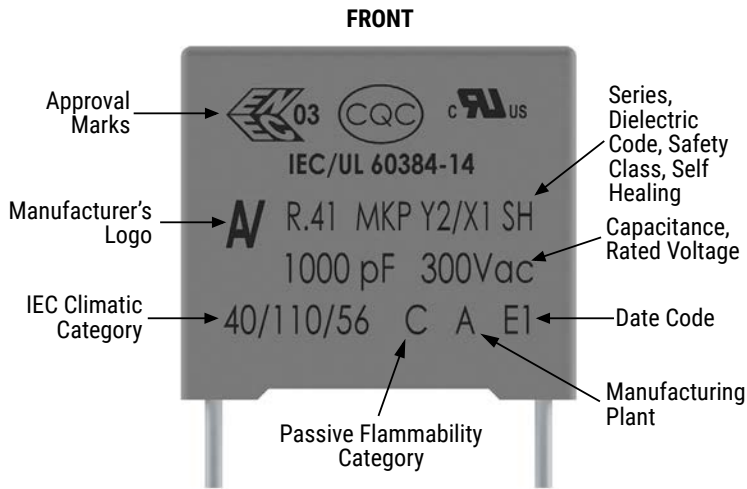

Lead Spacing 15 mm, 22.5 mm (small case sizes)

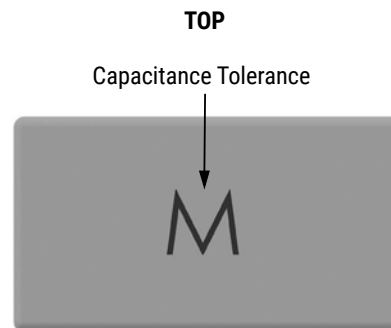
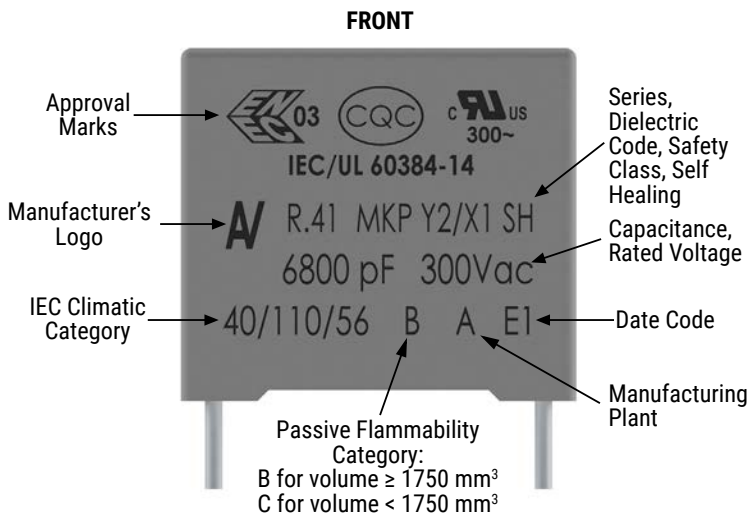

Marking cont'd

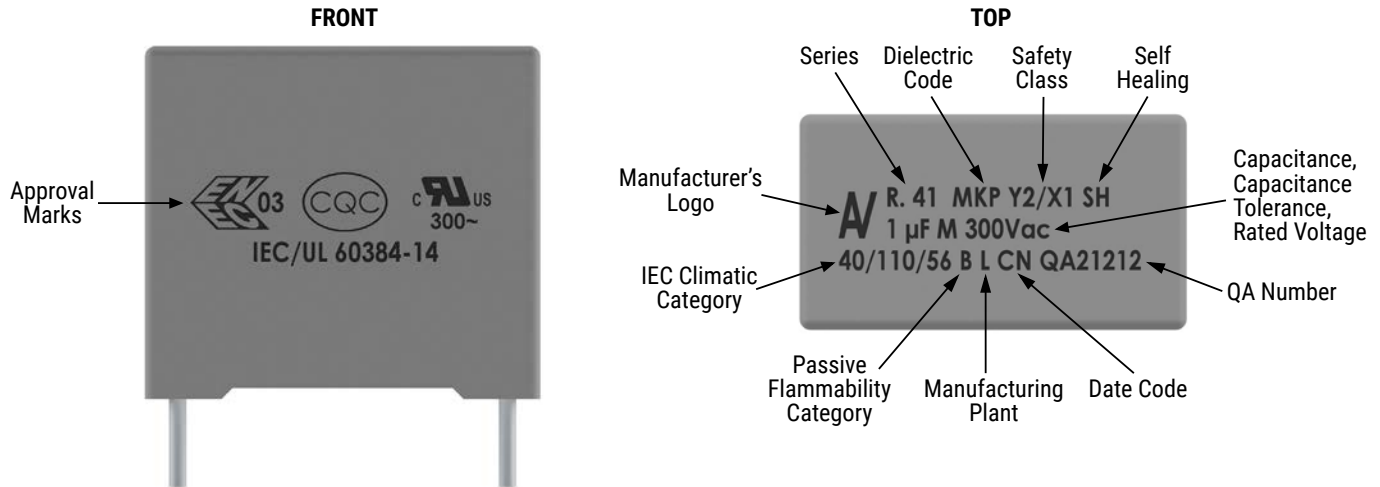

| Manufacturing Date Code (IEC 60062) | | | |
|-------------------------------------|------|-----------|------|
| Y = Year, Z = Month | | | |
| Year | Code | Month | Code |
| 2000 | M | January | 1 |
| 2001 | N | February | 2 |
| 2002 | P | March | 3 |
| 2003 | R | April | 4 |
| 2004 | S | May | 5 |
| 2005 | T | June | 6 |
| 2006 | U | July | 7 |
| 2007 | V | August | 8 |
| 2008 | W | September | 9 |
| 2009 | X | October | 0 |
| 2010 | A | November | N |
| 2011 | B | December | D |
| 2012 | C | | |
| 2013 | D | | |
| 2014 | E | | |
| 2015 | F | | |
| 2016 | H | | |
| 2017 | J | | |
| 2018 | K | | |
| 2019 | L | | |
| 2020 | M | | |

Packaging Quantities

| Lead Spacing (mm) | Thickness (mm) | Height (mm) | Length (mm) | Bulk Short Leads | Bulk Long Leads | Standard Reel ø 355 mm | Large Reel ø 500 mm | Ammo Taped |
|-------------------|----------------|-------------|-------------|------------------|-----------------|---------------------------|------------------------|------------|
| 10 | 4.0 | 9.0 | 13.0 | 2000 | 1800 | 750 | 1500 | 1000 |
| | 5.0 | 11.0 | 13.0 | 1300 | 1500 | 600 | 1250 | 800 |
| | 6.0 | 12.0 | 13.0 | 1000 | 1200 | 500 | 1000 | 680 |
| 15 | 5.0 | 11.0 | 18.0 | 2000 | 1000 | 600 | 1250 | 800 |
| | 6.0 | 12.0 | 18.0 | 1750 | 900 | 500 | 1000 | 680 |
| | 7.5 | 13.5 | 18.0 | 1000 | 700 | 350 | 800 | 500 |
| | 8.5 | 14.5 | 18.0 | 1000 | 500 | 300 | 700 | 440 |
| | 11.0 | 19.0 | 18.0 | 450 | 350 | - | 500 | 340 |
| 22.5 | 6.0 | 15.0 | 26.5 | 805 | 500 | - | 700 | 464 |
| | 7.0 | 16.0 | 26.5 | 700 | 500 | - | 550 | 380 |
| | 8.5 | 17.0 | 26.5 | 468 | 300 | - | 450 | 280 |
| | 10.0 | 18.5 | 26.5 | 396 | 300 | - | 350 | 235 |
| | 13.0 | 22.0 | 26.5 | 300 | 200 | - | 300 | - |
| 27.5 | 13.0 | 22.0 | 32.0 | 480 | 288 | - | 300 | - |
| | 14.0 | 28.0 | 32.0 | 352 | 176 | - | - | - |
| | 18.0 | 33.0 | 32.0 | 256 | 128 | - | - | - |
| 37.5 | 13.0 | 24.0 | 41.5 | 360 | 216 | - | - | - |
| | 16.0 | 28.5 | 41.5 | 216 | 108 | - | - | - |
| | 20.0 | 40.0 | 41.5 | 126 | 84 | - | - | - |

Lead Taping & Packaging (IEC 60286-2)

Figure 1
Lead Spacing 10 mm



Figure 2
Lead Spacing 15 mm

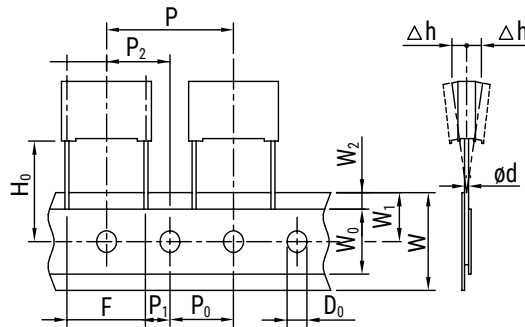
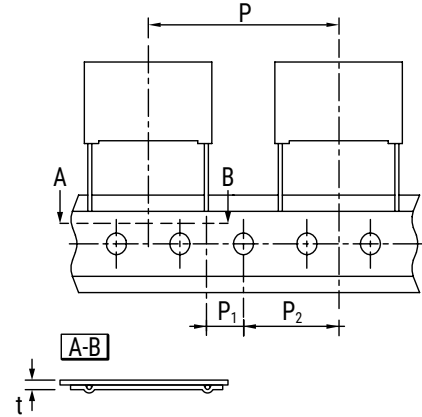

Figure 3
Lead Spacing 22.5 – 27.5 mm



Taping Specification

| Description | Symbol | Dimensions (mm) | | | | | Tol. |
|--------------------------------------|---------------------|-----------------|--------------|----------------|----------------|-----------|------|
| | | Lead Space | | | | | |
| | | 10 Fig. 1 | 15 Fig. 2 | 22.5 Fig. 3 | 27.5 Fig. 3 | | |
| Lead wire diameter | d | 0.6 | 0.6-0.8 | 0.8 | 0.8 | ±0.05 | |
| Taping lead space | P | 25.4 | 25.4 | 38.1 | 38.1 | ±1 | |
| Feed hole lead space * | P ₀ | 12.7 | 12.7 | 12.7 | 12.7 | ±0.2 ** | |
| Centering of the lead wire | P ₁ | 7.7 | 5.2 | 7.8 | 5.3 | ±0.7 | |
| Centering of the body | P ₂ | 12.7 | 12.7 | 19.05 | 19.05 | ±1.3 | |
| Lead spacing (pitch) *** | F | 10 | 15 | 22.5 | 27.5 | +0.6/-0.1 | |
| Component alignment | Δh | 0 | 0 | 0 | 0 | ±2 | |
| Height of component from tape center | H ₀ **** | 18.5 | 18.5 | 18.5 | 18.5 | ±0.5 | |
| Carrier tape width | W | 18 | 18 | 18 | 18 | +1 / -0.5 | |
| Hold down tape width | W ₀ | 9 | 10 | 10 | 10 | Minimum | |
| Hole position | W ₁ | 9 | 9 | 9 | 9 | ±0.5 | |
| Hold down tape position | W ₂ | 3 | 3 | 3 | 3 | Maximum | |
| Feed hole diameter | D ₀ | 4 | 4 | 4 | 4 | ±0.2 | |
| Total tape thickness | t | 0.7 | 0.7 | 0.7 | 0.7 | ±0.2 | |

* Available also in 15 mm.

** Maximum 1 mm on 20 lead spaces.

*** Pitches 15 mm and 10 mm taped to 7.5 mm (crimped leads) available upon request.

**** H₀ = 16.5 mm available upon request.

Lead Taping & Packaging (IEC 60286-2) cont'd

Ammo Specifications

| Dimensions (mm) | | |
|-----------------|-----|----|
| H | W | T |
| 360 | 340 | 59 |



Reel Specifications

| Reel Size | Dimensions (mm) | | |
|-----------|-----------------|----|------------|
| | D | H | W |
| Standard | 355 | 30 | 55 Maximum |
| Large | 500 | 25 | |



KEMET Electronics Corporation Sales Offices

For a complete list of our global sales offices, please visit www.kemet.com/sales.

Disclaimer

All product specifications, statements, information and data (collectively, the "Information") in this datasheet are subject to change. The customer is responsible for checking and verifying the extent to which the Information contained in this publication is applicable to an order at the time the order is placed.

All Information given herein is believed to be accurate and reliable, but it is presented without guarantee, warranty, or responsibility of any kind, expressed or implied.

Statements of suitability for certain applications are based on KEMET Electronics Corporation's ("KEMET") knowledge of typical operating conditions for such applications, but are not intended to constitute – and KEMET specifically disclaims – any warranty concerning suitability for a specific customer application or use. The Information is intended for use only by customers who have the requisite experience and capability to determine the correct products for their application. Any technical advice inferred from this Information or otherwise provided by KEMET with reference to the use of KEMET's products is given gratis, and KEMET assumes no obligation or liability for the advice given or results obtained.

Although KEMET designs and manufactures its products to the most stringent quality and safety standards, given the current state of the art, isolated component failures may still occur. Accordingly, customer applications which require a high degree of reliability or safety should employ suitable designs or other safeguards (such as installation of protective circuitry or redundancies) in order to ensure that the failure of an electrical component does not result in a risk of personal injury or property damage.

Although all product-related warnings, cautions and notes must be observed, the customer should not assume that all safety measures are indicated or that other measures may not be required.

KEMET is a registered trademark of KEMET Electronics Corporation.

单击下面可查看定价，库存，交付和生命周期等信息

[>>KEMET\(基美\)](#)