

# Not for new design. Use new F161 Series.

General Purpose, High Stability and AC Line EMI Suppression

## MMC Series Encapsulated Winding, Size 2220 – 6560, 50 – 400 VDC



### Overview

KEMET's MMC Series polyester (PET) film capacitor for surface mounting is encapsulated in self-extinguishing material meeting the requirements of UL 94 V-0.

### Applications

Typical applications include bypassing and signal coupling. MMC is a general purpose series designed for the highest reliability.

### Benefits

- Rated voltage: 50 – 400 VDC
- Rated voltage: 30 – 200 VAC
- Capacitance range: 0.001 – 15  $\mu$ F
- EIA size: 2220 – 6560
- Capacitance tolerance:  $\pm$ 5%,  $\pm$ 10%, other tolerances on request
- Climatic category: 55/100/56
- RoHS Compliant and lead-free terminations
- Operating temperature range of -55°C to +100°C



### Legacy Part Number System

MMC	5.7	102	K	50	J31	TR12
Series	Chip Length (mm)	Capacitance Code (pF)	Capacitance Tolerance	Rated Voltage (VDC)	Size Code	Packaging Code
Metallized Polyester	5.7 7.3 10.2 12.7 16.5	First two digits indicate the two most significant digits of the capacitance value in picofarads. The third digit is the number of following zeros.	J = $\pm$ 5 K = $\pm$ 10% Other tolerances on request	50 63 100 250 400	See Dimension Table	See Ordering Options Table

### New KEMET Part Number System

F	160	P	L	102	K	050	V
Capacitor Class	Series	Chip Size	Size Code	Capacitance Code (pF)	Capacitance Tolerance	Rated Voltage (VDC)	Packaging Code
F = Film	Metallized Polyester	P = 2220 S = 2824 W = 4036 Y = 5045 Z = 6560	See Dimension Table	First two digits indicate the two most significant digits of the capacitance value in picofarads. The third digit is the number of following zeros.	J = $\pm$ 5 K = $\pm$ 10% Other tolerances on request	050 = 50 063 = 63 100 = 100 250 = 250 400 = 400	See Ordering Options Table

One world. One KEMET

## Ordering Options Table

Chip Size (EIA)	Packaging Type	KEMET Packaging Code	Legacy Packaging Code
2220	<b>Standard Packaging Options</b>		
	Tape & Reel (Standard Reel)	V	TR12
	Bulk (Bag)	A	BULK
2824	<b>Standard Packaging Options</b>		
	Tape & Reel (Standard Reel)	V	TR12
	Bulk (Bag)	A	BULK
4036	<b>Standard Packaging Options</b>		
	Tape & Reel (Standard Reel)	V	TR16
	Bulk (Bag)	A	BULK
	<b>Other Packaging Options</b>		
	Tape & Reel (Vertical Orientation Standard Reel)	Y	TV24
5045	<b>Standard Packaging Options</b>		
	Tape & Reel (Standard Reel)	V	TR24
	Bulk (Bag)	A	BULK
	<b>Other Packaging Options</b>		
	Tape & Reel (Vertical Orientation Standard Reel)	Y	TV24
6560	<b>Standard Packaging Options</b>		
	Tape & Reel (Standard Reel)	V	TR24
	Bulk (Bag)	A	BULK
	<b>Other Packaging Options</b>		
	Tape & Reel (Vertical Orientation Standard Reel)	Y	TV44

## Dimensions – Millimeters

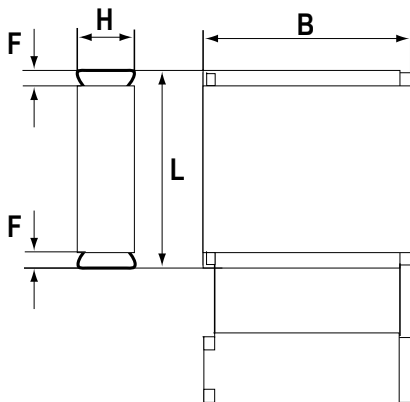

KEMET Size Code	Legacy Size Code	Chip Size (EIA)	B		H		L		F	
			Nominal	Tolerance	Nominal	Tolerance	Nominal	Tolerance	Nominal	Tolerance
PL	J31	2220	5.0	+/-0.2	2.5	+/-0.2	5.7	+/-0.2	0.5	Nominal
PP	J33	2220	5.0	+/-0.2	3.0	+/-0.2	5.7	+/-0.2	0.5	Nominal
PU	J35	2220	5.0	+/-0.2	4.0	+/-0.2	5.7	+/-0.2	0.5	Nominal
SG	K31	2824	6.0	+/-0.2	2.5	+/-0.2	7.3	+/-0.2	0.5	Nominal
SL	K33	2824	6.0	+/-0.2	3.0	+/-0.2	7.3	+/-0.2	0.5	Nominal
SP	K35	2824	6.0	+/-0.2	3.5	+/-0.2	7.3	+/-0.2	0.5	Nominal
ST	K37	2824	6.0	+/-0.2	4.5	+/-0.2	7.3	+/-0.2	0.5	Nominal
WP	A31	4036	9.1	+/-0.2	5.5	+/-0.2	10.2	+/-0.2	0.5	Nominal
YR	B31	5045	11.5	+/-0.2	6.5	+/-0.2	12.7	+/-0.2	0.5	Nominal
ZS	C31	6560	15	+/-0.2	7.0	+/-0.2	16.5	+/-0.2	0.5	Nominal

## Environmental Compliance

All KEMET surface mount capacitors are RoHS Compliant.



RoHS Compliant

## Performance Characteristics

Rated Voltage (VDC)	50	63	100	250	400
Rated Voltage (VAC)	30	40	63	160	200
Capacitance Range (μF)	0.001 – 15	0.001 – 4.7	0.001 – 3.3	0.001 – 1	0.001 – 0.47
Chip Size (EIA)	2220 – 6560				
Capacitance Tolerance	±5%, ±10%, other tolerances on request				
Category Temperature Range	-55°C to +100°C				
Rated Temperature	+85°C				
Voltage Derating	The rated voltage is decreased with 1.25%/°C from +85°C				
Climatic Category	55/100/56				
Test Voltage	1.6 x V <sub>R</sub> , 60 seconds				
Insulation Resistance	Measured at +20°C According to IEC 60384-2				
	Minimum Values Between Terminals				
		C ≤ 0.33 μF		C > 0.33 μF	
	V <sub>R</sub> ≤ 100	10,000 MΩ		3,000 MΩ • μF	
	V <sub>R</sub> > 100	30,000 MΩ		10,000 MΩ • μF	
Dissipation Factor	Maximum Values at +23°C				
		C ≤ 0.1 μF	0.1 < C < 1 μF	1 ≤ C ≤ 10 μF	C > 10 μF
	1 kHz	0.8%	0.8%	0.8%	0.8%
	10 kHz	1.2%	1.2%	1.5%	3.0%
	100 kHz	2.5%	3.0%		
Pulse Rise Time	The capacitors can withstand an unlimited number of pulses with a dV/dt according to Table 1. For voltages (V) lower than the rated voltage (V <sub>R</sub> ), the specified dV/dt can be multiplied by V <sub>R</sub> /V.				

### Capacitance vs. Temperature

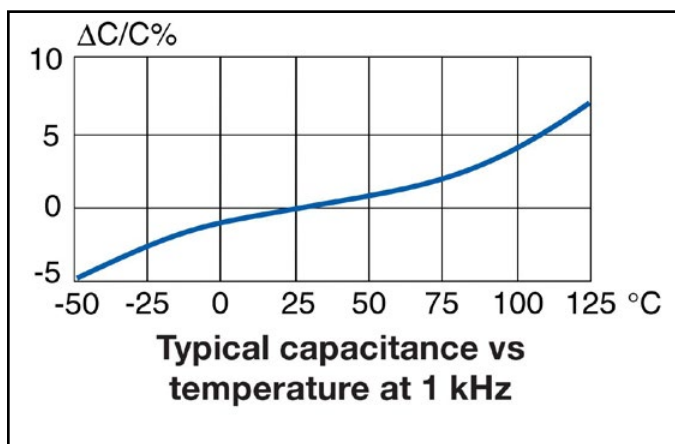

### Dissipation Factor vs. Temperature

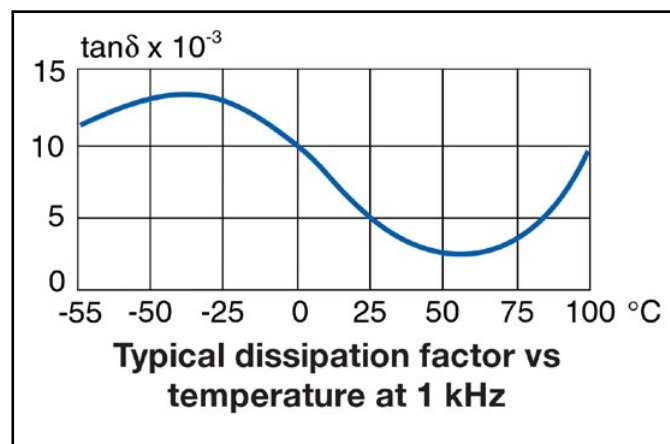

**Table 1 – Ratings & Part Number Reference**

VDC	VAC	Cap Value (µF)	Size Code (New/Legacy)	Dimensions in mm			Chip Size	dV/dt (V/µs)	New KEMET Part Number	Legacy Part Number
				B	H	L				
50	30	0.0010	PL/J31	5.0	2.5	5.7	2220	40	F160PL102(1)050(2)	MMC5.7102(1)50J31(2)
50	30	0.0012	PL/J31	5.0	2.5	5.7	2220	40	F160PL122(1)050(2)	MMC5.7122(1)50J31(2)
50	30	0.0015	PL/J31	5.0	2.5	5.7	2220	40	F160PL152(1)050(2)	MMC5.7152(1)50J31(2)
50	30	0.0018	PL/J31	5.0	2.5	5.7	2220	40	F160PL182(1)050(2)	MMC5.7182(1)50J31(2)
50	30	0.0022	PL/J31	5.0	2.5	5.7	2220	40	F160PL222(1)050(2)	MMC5.7222(1)50J31(2)
50	30	0.0027	PL/J31	5.0	2.5	5.7	2220	40	F160PL272(1)050(2)	MMC5.7272(1)50J31(2)
50	30	0.0033	PL/J31	5.0	2.5	5.7	2220	40	F160PL332(1)050(2)	MMC5.7332(1)50J31(2)
50	30	0.0039	PL/J31	5.0	2.5	5.7	2220	40	F160PL392(1)050(2)	MMC5.7392(1)50J31(2)
50	30	0.0047	PL/J31	5.0	2.5	5.7	2220	40	F160PL472(1)050(2)	MMC5.7472(1)50J31(2)
50	30	0.0056	PL/J31	5.0	2.5	5.7	2220	40	F160PL562(1)050(2)	MMC5.7562(1)50J31(2)
50	30	0.0068	PL/J31	5.0	2.5	5.7	2220	40	F160PL682(1)050(2)	MMC5.7682(1)50J31(2)
50	30	0.0082	PL/J31	5.0	2.5	5.7	2220	40	F160PL822(1)050(2)	MMC5.7822(1)50J31(2)
50	30	0.010	PL/J31	5.0	2.5	5.7	2220	40	F160PL103(1)050(2)	MMC5.7103(1)50J31(2)
50	30	0.012	PL/J31	5.0	2.5	5.7	2220	40	F160PL123(1)050(2)	MMC5.7123(1)50J31(2)
50	30	0.015	PL/J31	5.0	2.5	5.7	2220	30	F160PL153(1)050(2)	MMC5.7153(1)50J31(2)
50	30	0.018	PL/J31	5.0	2.5	5.7	2220	30	F160PL183(1)050(2)	MMC5.7183(1)50J31(2)
50	30	0.022	PL/J31	5.0	2.5	5.7	2220	30	F160PL223(1)050(2)	MMC5.7223(1)50J31(2)
50	30	0.027	PL/J31	5.0	2.5	5.7	2220	30	F160PL273(1)050(2)	MMC5.7273(1)50J31(2)
50	30	0.033	PL/J31	5.0	2.5	5.7	2220	30	F160PL333(1)050(2)	MMC5.7333(1)50J31(2)
50	30	0.039	PL/J31	5.0	2.5	5.7	2220	30	F160PL393(1)050(2)	MMC5.7393(1)50J31(2)
50	30	0.047	PL/J31	5.0	2.5	5.7	2220	30	F160PL473(1)050(2)	MMC5.7473(1)50J31(2)
50	30	0.056	PL/J31	5.0	2.5	5.7	2220	30	F160PL563(1)050(2)	MMC5.7563(1)50J31(2)
50	30	0.068	PL/J31	5.0	2.5	5.7	2220	20	F160PL683(1)050(2)	MMC5.7683(1)50J31(2)
50	30	0.082	PL/J31	5.0	2.5	5.7	2220	20	F160PL823(1)050(2)	MMC5.7823(1)50J31(2)
50	30	0.10	PL/J31	5.0	2.5	5.7	2220	20	F160PL104(1)050(2)	MMC5.7104(1)50J31(2)
50	30	0.12	PP/J33	5.0	3.0	5.7	2220	20	F160PP124(1)050(2)	MMC5.7124(1)50J33(2)
50	30	0.15	PP/J33	5.0	3.0	5.7	2220	20	F160PP154(1)050(2)	MMC5.7154(1)50J33(2)
50	30	0.18	PU/J35	5.0	4.0	5.7	2220	20	F160PU184(1)050(2)	MMC5.7184(1)50J35(2)
50	30	0.22	PU/J35	5.0	4.0	5.7	2220	20	F160PU224(1)050(2)	MMC5.7224(1)50J35(2)
50	30	0.0010	SG/K31	6.0	2.5	7.3	2824	50	F160SG102(1)050(2)	MMC7.3102(1)50K31(2)
50	30	0.0012	SG/K31	6.0	2.5	7.3	2824	50	F160SG122(1)050(2)	MMC7.3122(1)50K31(2)
50	30	0.0015	SG/K31	6.0	2.5	7.3	2824	50	F160SG152(1)050(2)	MMC7.3152(1)50K31(2)
50	30	0.0018	SG/K31	6.0	2.5	7.3	2824	50	F160SG182(1)050(2)	MMC7.3182(1)50K31(2)
50	30	0.0022	SG/K31	6.0	2.5	7.3	2824	50	F160SG222(1)050(2)	MMC7.3222(1)50K31(2)
50	30	0.0027	SG/K31	6.0	2.5	7.3	2824	50	F160SG272(1)050(2)	MMC7.3272(1)50K31(2)
50	30	0.0033	SG/K31	6.0	2.5	7.3	2824	50	F160SG332(1)050(2)	MMC7.3332(1)50K31(2)
50	30	0.0039	SG/K31	6.0	2.5	7.3	2824	50	F160SG392(1)050(2)	MMC7.3392(1)50K31(2)
50	30	0.0047	SG/K31	6.0	2.5	7.3	2824	50	F160SG472(1)050(2)	MMC7.3472(1)50K31(2)
50	30	0.0056	SG/K31	6.0	2.5	7.3	2824	50	F160SG562(1)050(2)	MMC7.3562(1)50K31(2)
50	30	0.0068	SG/K31	6.0	2.5	7.3	2824	40	F160SG682(1)050(2)	MMC7.3682(1)50K31(2)
50	30	0.0082	SG/K31	6.0	2.5	7.3	2824	40	F160SG822(1)050(2)	MMC7.3822(1)50K31(2)
50	30	0.010	SG/K31	6.0	2.5	7.3	2824	40	F160SG103(1)050(2)	MMC7.3103(1)50K31(2)
50	30	0.012	SG/K31	6.0	2.5	7.3	2824	40	F160SG123(1)050(2)	MMC7.3123(1)50K31(2)
50	30	0.015	SG/K31	6.0	2.5	7.3	2824	40	F160SG153(1)050(2)	MMC7.3153(1)50K31(2)
50	30	0.018	SG/K31	6.0	2.5	7.3	2824	40	F160SG183(1)050(2)	MMC7.3183(1)50K31(2)
50	30	0.022	SG/K31	6.0	2.5	7.3	2824	30	F160SG223(1)050(2)	MMC7.3223(1)50K31(2)
50	30	0.027	SG/K31	6.0	2.5	7.3	2824	30	F160SG273(1)050(2)	MMC7.3273(1)50K31(2)
50	30	0.033	SG/K31	6.0	2.5	7.3	2824	30	F160SG333(1)050(2)	MMC7.3333(1)50K31(2)
50	30	0.039	SG/K31	6.0	2.5	7.3	2824	30	F160SG393(1)050(2)	MMC7.3393(1)50K31(2)
50	30	0.047	SG/K31	6.0	2.5	7.3	2824	30	F160SG473(1)050(2)	MMC7.3473(1)50K31(2)
50	30	0.056	SG/K31	6.0	2.5	7.3	2824	30	F160SG563(1)050(2)	MMC7.3563(1)50K31(2)
50	30	0.068	SG/K31	6.0	2.5	7.3	2824	30	F160SG683(1)050(2)	MMC7.3683(1)50K31(2)
50	30	0.082	SG/K31	6.0	2.5	7.3	2824	30	F160SG823(1)050(2)	MMC7.3823(1)50K31(2)
50	30	0.10	SG/K31	6.0	2.5	7.3	2824	30	F160SG104(1)050(2)	MMC7.3104(1)50K31(2)
50	30	0.12	SG/K31	6.0	2.5	7.3	2824	30	F160SG124(1)050(2)	MMC7.3124(1)50K31(2)
50	30	0.15	SG/K31	6.0	2.5	7.3	2824	25	F160SG154(1)050(2)	MMC7.3154(1)50K31(2)
50	30	0.18	SL/K33	6.0	3.0	7.3	2824	25	F160SL184(1)050(2)	MMC7.3184(1)50K33(2)
50	30	0.22	SL/K33	6.0	3.0	7.3	2824	25	F160SL224(1)050(2)	MMC7.3224(1)50K33(2)
50	30	0.27	SP/K35	6.0	3.5	7.3	2824	25	F160SP274(1)050(2)	MMC7.3274(1)50K35(2)
VDC	VAC	Cap Value (µF)	Size Code (New/Legacy)	B (mm)	H (mm)	L (mm)	Chip Size	dV/dt (V/µs)	New KEMET Part Number	Legacy Part Number

(1) J = ±5%, K = ±10%, other tolerances on request.

(2) Insert ordering code for lead type and packaging. See Ordering Options Table for available options.

**Table 1 – Ratings & Part Number Reference cont'd**

VDC	VAC	Cap Value (µF)	Size Code (New/Legacy)	Dimensions in mm			Chip Size	dV/dt (V/µs)	New KEMET Part Number	Legacy Part Number
				B	H	L				
50	30	0.33	SP/K35	6.0	3.5	7.3	2824	25	F160SP334(1)050(2)	MMC7.3334(1)50K35(2)
50	30	0.39	SP/K35	6.0	3.5	7.3	2824	25	F160SP394(1)050(2)	MMC7.3394(1)50K35(2)
50	30	0.47	SP/K35	6.0	3.5	7.3	2824	25	F160SP474(1)050(2)	MMC7.3474(1)50K35(2)
50	30	0.56	ST/K37	6.0	4.5	7.3	2824	12	F160ST564(1)050(2)	MMC7.3564(1)50K37(2)
50	30	0.68	ST/K37	6.0	4.5	7.3	2824	12	F160ST684(1)050(2)	MMC7.3684(1)50K37(2)
50	30	0.82	ST/K37	6.0	4.5	7.3	2824	12	F160ST824(1)050(2)	MMC7.3824(1)50K37(2)
50	30	1.0	ST/K37	6.0	4.5	7.3	2824	12	F160ST105(1)050(2)	MMC7.3105(1)50K37(2)
50	30	0.022	WPI/A31	9.1	5.5	10.2	4036	40	F160WP223(1)050(2)	MMC10.2223(1)50A31(2)
50	30	0.027	WPI/A31	9.1	5.5	10.2	4036	40	F160WP273(1)050(2)	MMC10.2273(1)50A31(2)
50	30	0.033	WPI/A31	9.1	5.5	10.2	4036	40	F160WP333(1)050(2)	MMC10.2333(1)50A31(2)
50	30	0.039	WPI/A31	9.1	5.5	10.2	4036	40	F160WP393(1)050(2)	MMC10.2393(1)50A31(2)
50	30	0.047	WPI/A31	9.1	5.5	10.2	4036	40	F160WP473(1)050(2)	MMC10.2473(1)50A31(2)
50	30	0.056	WPI/A31	9.1	5.5	10.2	4036	40	F160WP563(1)050(2)	MMC10.2563(1)50A31(2)
50	30	0.068	WPI/A31	9.1	5.5	10.2	4036	40	F160WP683(1)050(2)	MMC10.2683(1)50A31(2)
50	30	0.082	WPI/A31	9.1	5.5	10.2	4036	40	F160WP823(1)050(2)	MMC10.2823(1)50A31(2)
50	30	0.10	WPI/A31	9.1	5.5	10.2	4036	30	F160WP104(1)050(2)	MMC10.2104(1)50A31(2)
50	30	0.12	WPI/A31	9.1	5.5	10.2	4036	30	F160WP124(1)050(2)	MMC10.2124(1)50A31(2)
50	30	0.15	WPI/A31	9.1	5.5	10.2	4036	30	F160WP154(1)050(2)	MMC10.2154(1)50A31(2)
50	30	0.18	WPI/A31	9.1	5.5	10.2	4036	20	F160WP184(1)050(2)	MMC10.2184(1)50A31(2)
50	30	0.22	WPI/A31	9.1	5.5	10.2	4036	20	F160WP224(1)050(2)	MMC10.2224(1)50A31(2)
50	30	0.27	WPI/A31	9.1	5.5	10.2	4036	20	F160WP274(1)050(2)	MMC10.2274(1)50A31(2)
50	30	0.33	WPI/A31	9.1	5.5	10.2	4036	20	F160WP334(1)050(2)	MMC10.2334(1)50A31(2)
50	30	0.39	WPI/A31	9.1	5.5	10.2	4036	20	F160WP394(1)050(2)	MMC10.2394(1)50A31(2)
50	30	0.47	WPI/A31	9.1	5.5	10.2	4036	20	F160WP474(1)050(2)	MMC10.2474(1)50A31(2)
50	30	0.56	WPI/A31	9.1	5.5	10.2	4036	12	F160WP564(1)050(2)	MMC10.2564(1)50A31(2)
50	30	0.68	WPI/A31	9.1	5.5	10.2	4036	12	F160WP684(1)050(2)	MMC10.2684(1)50A31(2)
50	30	0.82	WPI/A31	9.1	5.5	10.2	4036	12	F160WP824(1)050(2)	MMC10.2824(1)50A31(2)
50	30	1.0	WPI/A31	9.1	5.5	10.2	4036	12	F160WP105(1)050(2)	MMC10.2105(1)50A31(2)
50	30	1.2	WPI/A31	9.1	5.5	10.2	4036	12	F160WP125(1)050(2)	MMC10.2125(1)50A31(2)
50	30	1.5	WPI/A31	9.1	5.5	10.2	4036	12	F160WP155(1)050(2)	MMC10.2155(1)50A31(2)
50	30	1.8	WPI/A31	9.1	5.5	10.2	4036	12	F160WP185(1)050(2)	MMC10.2185(1)50A31(2)
50	30	2.2	WPI/A31	9.1	5.5	10.2	4036	12	F160WP225(1)050(2)	MMC10.2225(1)50A31(2)
50	30	2.7	YR/B31	11.5	6.5	12.7	5045	8	F160YR275(1)050(2)	MMC12.7275(1)50B31(2)
50	30	3.3	YR/B31	11.5	6.5	12.7	5045	8	F160YR335(1)050(2)	MMC12.7335(1)50B31(2)
50	30	3.9	YR/B31	11.5	6.5	12.7	5045	8	F160YR395(1)050(2)	MMC12.7395(1)50B31(2)
50	30	4.7	YR/B31	11.5	6.5	12.7	5045	8	F160YR475(1)050(2)	MMC12.7475(1)50B31(2)
50	30	5.6	ZS/C31	15.0	7.0	16.5	5045	5	F160ZS565(1)050(2)	MMC16.5565(1)50C31(2)
50	30	6.8	ZS/C31	15.0	7.0	16.5	5045	5	F160ZS685(1)050(2)	MMC16.5685(1)50C31(2)
50	30	8.2	ZS/C31	15.0	7.0	16.5	5045	5	F160ZS825(1)050(2)	MMC16.5825(1)50C31(2)
50	30	10.0	ZS/C31	15.0	7.0	16.5	5045	5	F160ZS106(1)050(2)	MMC16.5106(1)50C31(2)
50	30	12.0	ZS/C31	15.0	7.0	16.5	5045	5	F160ZS126(1)050(2)	MMC16.5126(1)50C31(2)
50	30	15.0	ZS/C31	15.0	7.0	16.5	5045	5	F160ZS156(1)050(2)	MMC16.5156(1)50C31(2)
63	40	0.0010	SG/K31	6.0	2.5	7.3	2824	50	F160SG102(1)063(2)	MMC7.3102(1)63K31(2)
63	40	0.0012	SG/K31	6.0	2.5	7.3	2824	50	F160SG122(1)063(2)	MMC7.3122(1)63K31(2)
63	40	0.0015	SG/K31	6.0	2.5	7.3	2824	50	F160SG152(1)063(2)	MMC7.3152(1)63K31(2)
63	40	0.0018	SG/K31	6.0	2.5	7.3	2824	50	F160SG182(1)063(2)	MMC7.3182(1)63K31(2)
63	40	0.0022	SG/K31	6.0	2.5	7.3	2824	50	F160SG222(1)063(2)	MMC7.3222(1)63K31(2)
63	40	0.0027	SG/K31	6.0	2.5	7.3	2824	50	F160SG272(1)063(2)	MMC7.3272(1)63K31(2)
63	40	0.0033	SG/K31	6.0	2.5	7.3	2824	50	F160SG332(1)063(2)	MMC7.3332(1)63K31(2)
63	40	0.0039	SG/K31	6.0	2.5	7.3	2824	50	F160SG392(1)063(2)	MMC7.3392(1)63K31(2)
63	40	0.0047	SG/K31	6.0	2.5	7.3	2824	50	F160SG472(1)063(2)	MMC7.3472(1)63K31(2)
63	40	0.0056	SG/K31	6.0	2.5	7.3	2824	50	F160SG562(1)063(2)	MMC7.3562(1)63K31(2)
63	40	0.0068	SG/K31	6.0	2.5	7.3	2824	40	F160SG682(1)063(2)	MMC7.3682(1)63K31(2)
63	40	0.0082	SG/K31	6.0	2.5	7.3	2824	40	F160SG822(1)063(2)	MMC7.3822(1)63K31(2)
63	40	0.010	SG/K31	6.0	2.5	7.3	2824	40	F160SG103(1)063(2)	MMC7.3103(1)63K31(2)
63	40	0.012	SG/K31	6.0	2.5	7.3	2824	40	F160SG123(1)063(2)	MMC7.3123(1)63K31(2)
63	40	0.015	SG/K31	6.0	2.5	7.3	2824	40	F160SG153(1)063(2)	MMC7.3153(1)63K31(2)
63	40	0.018	SG/K31	6.0	2.5	7.3	2824	40	F160SG183(1)063(2)	MMC7.3183(1)63K31(2)
63	40	0.022	SG/K31	6.0	2.5	7.3	2824	30	F160SG223(1)063(2)	MMC7.3223(1)63K31(2)

(1) J = ±5%, K = ±10%, other tolerances on request.

(2) Insert ordering code for lead type and packaging. See Ordering Options Table for available options.

**Table 1 – Ratings & Part Number Reference cont'd**

VDC	VAC	Cap Value (μF)	Size Code (New/Legacy)	Dimensions in mm			Chip Size	dV/dt (V/μs)	New KEMET Part Number	Legacy Part Number
				B	H	L				
63	40	0.027	SG/K31	6.0	2.5	7.3	2824	30	F160SG273(1)063(2)	MMC7.3273(1)63K31(2)
63	40	0.033	SG/K31	6.0	2.5	7.3	2824	30	F160SG333(1)063(2)	MMC7.3333(1)63K31(2)
63	40	0.039	SG/K31	6.0	2.5	7.3	2824	30	F160SG393(1)063(2)	MMC7.3393(1)63K31(2)
63	40	0.047	SG/K31	6.0	2.5	7.3	2824	30	F160SG473(1)063(2)	MMC7.3473(1)63K31(2)
63	40	0.056	SG/K31	6.0	2.5	7.3	2824	30	F160SG563(1)063(2)	MMC7.3563(1)63K31(2)
63	40	0.068	SG/K31	6.0	2.5	7.3	2824	30	F160SG683(1)063(2)	MMC7.3683(1)63K31(2)
63	40	0.082	SG/K31	6.0	2.5	7.3	2824	30	F160SG823(1)063(2)	MMC7.3823(1)63K31(2)
63	40	0.10	SG/K31	6.0	2.5	7.3	2824	30	F160SG104(1)063(2)	MMC7.3104(1)63K31(2)
63	40	0.12	SG/K31	6.0	2.5	7.3	2824	30	F160SG124(1)063(2)	MMC7.3124(1)63K31(2)
63	40	0.15	SG/K31	6.0	2.5	7.3	2824	30	F160SG154(1)063(2)	MMC7.3154(1)63K31(2)
63	40	0.18	SL/K33	6.0	3.0	7.3	2824	25	F160SL184(1)063(2)	MMC7.3184(1)63K33(2)
63	40	0.22	SL/K33	6.0	3.0	7.3	2824	25	F160SL224(1)063(2)	MMC7.3224(1)63K33(2)
63	40	0.27	SP/K35	6.0	3.5	7.3	2824	25	F160SP274(1)063(2)	MMC7.3274(1)63K35(2)
63	40	0.33	SP/K35	6.0	3.5	7.3	2824	25	F160SP334(1)063(2)	MMC7.3334(1)63K35(2)
63	40	0.39	SP/K35	6.0	3.5	7.3	2824	25	F160SP394(1)063(2)	MMC7.3394(1)63K35(2)
63	40	0.47	SP/K35	6.0	3.5	7.3	2824	25	F160SP474(1)063(2)	MMC7.3474(1)63K35(2)
63	40	0.022	WPI/A31	9.1	5.5	10.2	4036	40	F160WP223(1)063(2)	MMC10.2223(1)63A31(2)
63	40	0.027	WPI/A31	9.1	5.5	10.2	4036	40	F160WP273(1)063(2)	MMC10.2273(1)63A31(2)
63	40	0.033	WPI/A31	9.1	5.5	10.2	4036	40	F160WP333(1)063(2)	MMC10.2333(1)63A31(2)
63	40	0.039	WPI/A31	9.1	5.5	10.2	4036	40	F160WP393(1)063(2)	MMC10.2393(1)63A31(2)
63	40	0.047	WPI/A31	9.1	5.5	10.2	4036	40	F160WP473(1)063(2)	MMC10.2473(1)63A31(2)
63	40	0.056	WPI/A31	9.1	5.5	10.2	4036	40	F160WP563(1)063(2)	MMC10.2563(1)63A31(2)
63	40	0.068	WPI/A31	9.1	5.5	10.2	4036	40	F160WP683(1)063(2)	MMC10.2683(1)63A31(2)
63	40	0.082	WPI/A31	9.1	5.5	10.2	4036	40	F160WP823(1)063(2)	MMC10.2823(1)63A31(2)
63	40	0.10	WPI/A31	9.1	5.5	10.2	4036	30	F160WP104(1)063(2)	MMC10.2104(1)63A31(2)
63	40	0.12	WPI/A31	9.1	5.5	10.2	4036	30	F160WP124(1)063(2)	MMC10.2124(1)63A31(2)
63	40	0.15	WPI/A31	9.1	5.5	10.2	4036	30	F160WP154(1)063(2)	MMC10.2154(1)63A31(2)
63	40	0.18	WPI/A31	9.1	5.5	10.2	4036	20	F160WP184(1)063(2)	MMC10.2184(1)63A31(2)
63	40	0.22	WPI/A31	9.1	5.5	10.2	4036	20	F160WP224(1)063(2)	MMC10.2224(1)63A31(2)
63	40	0.27	WPI/A31	9.1	5.5	10.2	4036	20	F160WP274(1)063(2)	MMC10.2274(1)63A31(2)
63	40	0.33	WPI/A31	9.1	5.5	10.2	4036	20	F160WP334(1)063(2)	MMC10.2334(1)63A31(2)
63	40	0.39	WPI/A31	9.1	5.5	10.2	4036	20	F160WP394(1)063(2)	MMC10.2394(1)63A31(2)
63	40	0.47	WPI/A31	9.1	5.5	10.2	4036	20	F160WP474(1)063(2)	MMC10.2474(1)63A31(2)
63	40	0.56	WPI/A31	9.1	5.5	10.2	4036	12	F160WP564(1)063(2)	MMC10.2564(1)63A31(2)
63	40	0.68	WPI/A31	9.1	5.5	10.2	4036	12	F160WP684(1)063(2)	MMC10.2684(1)63A31(2)
63	40	0.82	WPI/A31	9.1	5.5	10.2	4036	12	F160WP824(1)063(2)	MMC10.2824(1)63A31(2)
63	40	1.0	WPI/A31	9.1	5.5	10.2	4036	12	F160WP105(1)063(2)	MMC10.2105(1)63A31(2)
63	40	1.2	WPI/A31	9.1	5.5	10.2	4036	12	F160WP125(1)063(2)	MMC10.2125(1)63A31(2)
63	40	1.5	WPI/A31	9.1	5.5	10.2	4036	12	F160WP155(1)063(2)	MMC10.2155(1)63A31(2)
63	40	1.8	YR/B31	11.5	6.5	12.7	6560	8	F160YR185(1)063(2)	MMC12.7185(1)63B31(2)
63	40	2.2	YR/B31	11.5	6.5	12.7	6560	8	F160YR225(1)063(2)	MMC12.7225(1)63B31(2)
63	40	2.7	YR/B31	11.5	6.5	12.7	6560	8	F160YR275(1)063(2)	MMC12.7275(1)63B31(2)
63	40	3.3	YR/B31	11.5	6.5	12.7	6560	8	F160YR335(1)063(2)	MMC12.7335(1)63B31(2)
63	40	3.9	ZS/C31	15.0	7.0	16.5	6560	5	F160ZS395(1)063(2)	MMC16.5395(1)63C31(2)
63	40	4.7	ZS/C31	15.0	7.0	16.5	6560	5	F160ZS475(1)063(2)	MMC16.5475(1)63C31(2)
100	63	0.0010	PL/J31	5.0	2.5	5.7	2220	40	F160PL102(1)100(2)	MMC5.7102(1)100J31(2)
100	63	0.0012	PL/J31	5.0	2.5	5.7	2220	40	F160PL122(1)100(2)	MMC5.7122(1)100J31(2)
100	63	0.0015	PL/J31	5.0	2.5	5.7	2220	40	F160PL152(1)100(2)	MMC5.7152(1)100J31(2)
100	63	0.0018	PL/J31	5.0	2.5	5.7	2220	40	F160PL182(1)100(2)	MMC5.7182(1)100J31(2)
100	63	0.0022	PL/J31	5.0	2.5	5.7	2220	40	F160PL222(1)100(2)	MMC5.7222(1)100J31(2)
100	63	0.0027	PL/J31	5.0	2.5	5.7	2220	40	F160PL272(1)100(2)	MMC5.7272(1)100J31(2)
100	63	0.0033	PL/J31	5.0	2.5	5.7	2220	40	F160PL332(1)100(2)	MMC5.7332(1)100J31(2)
100	63	0.0039	PL/J31	5.0	2.5	5.7	2220	40	F160PL392(1)100(2)	MMC5.7392(1)100J31(2)
100	63	0.0047	PL/J31	5.0	2.5	5.7	2220	40	F160PL472(1)100(2)	MMC5.7472(1)100J31(2)
100	63	0.0056	PL/J31	5.0	2.5	5.7	2220	40	F160PL562(1)100(2)	MMC5.7562(1)100J31(2)
100	63	0.0068	PL/J31	5.0	2.5	5.7	2220	40	F160PL682(1)100(2)	MMC5.7682(1)100J31(2)
100	63	0.0082	PL/J31	5.0	2.5	5.7	2220	40	F160PL822(1)100(2)	MMC5.7822(1)100J31(2)
100	63	0.010	PL/J31	5.0	2.5	5.7	2220	40	F160PL103(1)100(2)	MMC5.7103(1)100J31(2)
100	63	0.012	PL/J31	5.0	2.5	5.7	2220	40	F160PL123(1)100(2)	MMC5.7123(1)100J31(2)
VDC	VAC	Cap Value (μF)	Size Code (New/Legacy)	B (mm)	H (mm)	L (mm)	Chip Size	dV/dt (V/μs)	New KEMET Part Number	Legacy Part Number

(1) J = ±5%, K = ±10%, other tolerances on request.

(2) Insert ordering code for lead type and packaging. See Ordering Options Table for available options.

**Table 1 – Ratings & Part Number Reference cont'd**

VDC	VAC	Cap Value (µF)	Size Code (New/Legacy)	Dimensions in mm			Chip Size	dV/dt (V/µs)	New KEMET Part Number	Legacy Part Number
				B	H	L				
100	63	0.015	PL/J31	5.0	2.5	5.7	2220	30	F160PL153(1)100(2)	MMC5.7153(1)100J31(2)
100	63	0.018	PL/J31	5.0	2.5	5.7	2220	30	F160PL183(1)100(2)	MMC5.7183(1)100J31(2)
100	63	0.022	PL/J31	5.0	2.5	5.7	2220	30	F160PL223(1)100(2)	MMC5.7223(1)100J31(2)
100	63	0.027	PL/J31	5.0	2.5	5.7	2220	30	F160PL273(1)100(2)	MMC5.7273(1)100J31(2)
100	63	0.033	PL/J31	5.0	2.5	5.7	2220	30	F160PL333(1)100(2)	MMC5.7333(1)100J31(2)
100	63	0.039	PL/J31	5.0	2.5	5.7	2220	30	F160PL393(1)100(2)	MMC5.7393(1)100J31(2)
100	63	0.047	PL/J31	5.0	2.5	5.7	2220	30	F160PL473(1)100(2)	MMC5.7473(1)100J31(2)
100	63	0.056	PP/J33	5.0	3.0	5.7	2220	30	F160PP563(1)100(2)	MMC5.7563(1)100J33(2)
100	63	0.068	PP/J33	5.0	3.0	5.7	2220	30	F160PP683(1)100(2)	MMC5.7683(1)100J33(2)
100	63	0.082	PU/J35	5.0	4.0	5.7	2220	30	F160PU823(1)100(2)	MMC5.7823(1)100J35(2)
100	63	0.10	PU/J35	5.0	4.0	5.7	2220	30	F160PU104(1)100(2)	MMC5.7104(1)100J35(2)
100	63	0.0010	SG/K31	6.0	2.5	7.3	2824	50	F160SG102(1)100(2)	MMC7.3102(1)100K31(2)
100	63	0.0012	SG/K31	6.0	2.5	7.3	2824	50	F160SG122(1)100(2)	MMC7.3122(1)100K31(2)
100	63	0.0015	SG/K31	6.0	2.5	7.3	2824	50	F160SG152(1)100(2)	MMC7.3152(1)100K31(2)
100	63	0.0018	SG/K31	6.0	2.5	7.3	2824	50	F160SG182(1)100(2)	MMC7.3182(1)100K31(2)
100	63	0.0022	SG/K31	6.0	2.5	7.3	2824	50	F160SG222(1)100(2)	MMC7.3222(1)100K31(2)
100	63	0.0027	SG/K31	6.0	2.5	7.3	2824	50	F160SG272(1)100(2)	MMC7.3272(1)100K31(2)
100	63	0.0033	SG/K31	6.0	2.5	7.3	2824	50	F160SG332(1)100(2)	MMC7.3332(1)100K31(2)
100	63	0.0039	SG/K31	6.0	2.5	7.3	2824	50	F160SG392(1)100(2)	MMC7.3392(1)100K31(2)
100	63	0.0047	SG/K31	6.0	2.5	7.3	2824	50	F160SG472(1)100(2)	MMC7.3472(1)100K31(2)
100	63	0.0056	SG/K31	6.0	2.5	7.3	2824	50	F160SG562(1)100(2)	MMC7.3562(1)100K31(2)
100	63	0.0068	SG/K31	6.0	2.5	7.3	2824	40	F160SG682(1)100(2)	MMC7.3682(1)100K31(2)
100	63	0.0082	SG/K31	6.0	2.5	7.3	2824	40	F160SG822(1)100(2)	MMC7.3822(1)100K31(2)
100	63	0.010	SG/K31	6.0	2.5	7.3	2824	40	F160SG103(1)100(2)	MMC7.3103(1)100K31(2)
100	63	0.012	SG/K31	6.0	2.5	7.3	2824	40	F160SG123(1)100(2)	MMC7.3123(1)100K31(2)
100	63	0.015	SG/K31	6.0	2.5	7.3	2824	40	F160SG153(1)100(2)	MMC7.3153(1)100K31(2)
100	63	0.018	SG/K31	6.0	2.5	7.3	2824	40	F160SG183(1)100(2)	MMC7.3183(1)100K31(2)
100	63	0.022	SG/K31	6.0	2.5	7.3	2824	30	F160SG223(1)100(2)	MMC7.3223(1)100K31(2)
100	63	0.027	SG/K31	6.0	2.5	7.3	2824	30	F160SG273(1)100(2)	MMC7.3273(1)100K31(2)
100	63	0.033	SG/K31	6.0	2.5	7.3	2824	30	F160SG333(1)100(2)	MMC7.3333(1)100K31(2)
100	63	0.039	SG/K31	6.0	2.5	7.3	2824	30	F160SG393(1)100(2)	MMC7.3393(1)100K31(2)
100	63	0.047	SG/K31	6.0	2.5	7.3	2824	30	F160SG473(1)100(2)	MMC7.3473(1)100K31(2)
100	63	0.056	SG/K31	6.0	2.5	7.3	2824	30	F160SG563(1)100(2)	MMC7.3563(1)100K31(2)
100	63	0.068	SG/K31	6.0	2.5	7.3	2824	30	F160SG683(1)100(2)	MMC7.3683(1)100K31(2)
100	63	0.082	SG/K31	6.0	2.5	7.3	2824	30	F160SG823(1)100(2)	MMC7.3823(1)100K31(2)
100	63	0.10	SG/K31	6.0	2.5	7.3	2824	30	F160SG104(1)100(2)	MMC7.3104(1)100K31(2)
100	63	0.12	SL/K33	6.0	3.0	7.3	2824	30	F160SL124(1)100(2)	MMC7.3124(1)100K33(2)
100	63	0.15	SP/K35	6.0	3.5	7.3	2824	30	F160SP154(1)100(2)	MMC7.3154(1)100K35(2)
100	63	0.18	SP/K35	6.0	3.5	7.3	2824	30	F160SP184(1)100(2)	MMC7.3184(1)100K35(2)
100	63	0.22	ST/K35	6.0	4.5	7.3	2824	30	F160ST224(1)100(2)	MMC7.3224(1)100K37(2)
100	63	0.022	WP/A31	9.1	5.5	10.2	4036	40	F160WP223(1)100(2)	MMC10.2223(1)100A31(2)
100	63	0.027	WP/A31	9.1	5.5	10.2	4036	40	F160WP273(1)100(2)	MMC10.2273(1)100A31(2)
100	63	0.033	WP/A31	9.1	5.5	10.2	4036	40	F160WP333(1)100(2)	MMC10.2333(1)100A31(2)
100	63	0.039	WP/A31	9.1	5.5	10.2	4036	40	F160WP393(1)100(2)	MMC10.2393(1)100A31(2)
100	63	0.047	WP/A31	9.1	5.5	10.2	4036	40	F160WP473(1)100(2)	MMC10.2473(1)100A31(2)
100	63	0.056	WP/A31	9.1	5.5	10.2	4036	40	F160WP563(1)100(2)	MMC10.2563(1)100A31(2)
100	63	0.068	WP/A31	9.1	5.5	10.2	4036	40	F160WP683(1)100(2)	MMC10.2683(1)100A31(2)
100	63	0.082	WP/A31	9.1	5.5	10.2	4036	40	F160WP823(1)100(2)	MMC10.2823(1)100A31(2)
100	63	0.10	WP/A31	9.1	5.5	10.2	4036	30	F160WP104(1)100(2)	MMC10.2104(1)100A31(2)
100	63	0.12	WP/A31	9.1	5.5	10.2	4036	30	F160WP124(1)100(2)	MMC10.2124(1)100A31(2)
100	63	0.15	WP/A31	9.1	5.5	10.2	4036	30	F160WP154(1)100(2)	MMC10.2154(1)100A31(2)
100	63	0.18	WP/A31	9.1	5.5	10.2	4036	20	F160WP184(1)100(2)	MMC10.2184(1)100A31(2)
100	63	0.22	WP/A31	9.1	5.5	10.2	4036	20	F160WP224(1)100(2)	MMC10.2224(1)100A31(2)
100	63	0.27	WP/A31	9.1	5.5	10.2	4036	20	F160WP274(1)100(2)	MMC10.2274(1)100A31(2)
100	63	0.33	WP/A31	9.1	5.5	10.2	4036	20	F160WP334(1)100(2)	MMC10.2334(1)100A31(2)
100	63	0.39	WP/A31	9.1	5.5	10.2	4036	20	F160WP394(1)100(2)	MMC10.2394(1)100A31(2)
100	63	0.47	WP/A31	9.1	5.5	10.2	4036	20	F160WP474(1)100(2)	MMC10.2474(1)100A31(2)
100	63	0.56	YR/B31	11.5	6.5	12.7	5045	12	F160YR564(1)100(2)	MMC12.7564(1)100B31(2)
100	63	0.68	YR/B31	11.5	6.5	12.7	5045	12	F160YR684(1)100(2)	MMC12.7684(1)100B31(2)

(1) J = ±5%, K = ±10%, other tolerances on request.

(2) Insert ordering code for lead type and packaging. See Ordering Options Table for available options.



**Table 1 – Ratings & Part Number Reference cont'd**

VDC	VAC	Cap Value (µF)	Size Code (New/Legacy)	Dimensions in mm			Chip Size	dV/dt (V/µs)	New KEMET Part Number	Legacy Part Number
				B	H	L				
100	63	0.82	YR/B31	11.5	6.5	12.7	5045	12	F160YR824(1)100(2)	MMC12.7824(1)100B31(2)
100	63	1.0	YR/B31	11.5	6.5	12.7	5045	12	F160YR105(1)100(2)	MMC12.7105(1)100B31(2)
100	63	1.2	ZS/C31	15.0	7.0	16.5	6560	8	F160ZS125(1)100(2)	MMC16.5125(1)100C31(2)
100	63	1.5	ZS/C31	15.0	7.0	16.5	6560	8	F160ZS155(1)100(2)	MMC16.5155(1)100C31(2)
100	63	1.8	ZS/C31	15.0	7.0	16.5	6560	8	F160ZS185(1)100(2)	MMC16.5185(1)100C31(2)
100	63	2.2	ZS/C31	15.0	7.0	16.5	6560	8	F160ZS225(1)100(2)	MMC16.5225(1)100C31(2)
100	63	2.7	ZS/C31	15.0	7.0	16.5	6560	8	F160ZS275(1)100(2)	MMC16.5275(1)100C31(2)
100	63	3.3	ZS/C31	15.0	7.0	16.5	6560	8	F160ZS335(1)100(2)	MMC16.5335(1)100C31(2)
250	160	0.0010	PL/J31	5.0	2.5	5.7	2220	40	F160PL102(1)250(2)	MMC5.7102(1)250J31(2)
250	160	0.0012	PL/J31	5.0	2.5	5.7	2220	40	F160PL122(1)250(2)	MMC5.7122(1)250J31(2)
250	160	0.0015	PL/J31	5.0	2.5	5.7	2220	40	F160PL152(1)250(2)	MMC5.7152(1)250J31(2)
250	160	0.0018	PL/J31	5.0	2.5	5.7	2220	40	F160PL182(1)250(2)	MMC5.7182(1)250J31(2)
250	160	0.0022	PL/J31	5.0	2.5	5.7	2220	40	F160PL222(1)250(2)	MMC5.7222(1)250J31(2)
250	160	0.0027	PL/J31	5.0	2.5	5.7	2220	40	F160PL272(1)250(2)	MMC5.7272(1)250J31(2)
250	160	0.0033	PL/J31	5.0	2.5	5.7	2220	40	F160PL332(1)250(2)	MMC5.7332(1)250J31(2)
250	160	0.0039	PL/J31	5.0	2.5	5.7	2220	40	F160PL392(1)250(2)	MMC5.7392(1)250J31(2)
250	160	0.0047	PL/J31	5.0	2.5	5.7	2220	40	F160PL472(1)250(2)	MMC5.7472(1)250J31(2)
250	160	0.0056	PL/J31	5.0	2.5	5.7	2220	40	F160PL562(1)250(2)	MMC5.7562(1)250J31(2)
250	160	0.0068	PL/J31	5.0	2.5	5.7	2220	40	F160PL682(1)250(2)	MMC5.7682(1)250J31(2)
250	160	0.0082	PL/J31	5.0	2.5	5.7	2220	40	F160PL822(1)250(2)	MMC5.7822(1)250J31(2)
250	160	0.010	PL/J31	5.0	2.5	5.7	2220	40	F160PL103(1)250(2)	MMC5.7103(1)250J31(2)
250	160	0.012	PL/J31	5.0	2.5	5.7	2220	40	F160PL123(1)250(2)	MMC5.7123(1)250J31(2)
250	160	0.015	PP/J33	5.0	3.0	5.7	2220	40	F160PP153(1)250(2)	MMC5.7153(1)250J33(2)
250	160	0.018	PU/J35	5.0	4.0	5.7	2220	40	F160PU183(1)250(2)	MMC5.7183(1)250J35(2)
250	160	0.022	PU/J35	5.0	4.0	5.7	2220	40	F160PU223(1)250(2)	MMC5.7223(1)250J35(2)
250	160	0.0010	SG/K31	6.0	2.5	7.3	2824	50	F160SG102(1)250(2)	MMC7.3102(1)250K31(2)
250	160	0.0012	SG/K31	6.0	2.5	7.3	2824	50	F160SG122(1)250(2)	MMC7.3122(1)250K31(2)
250	160	0.0015	SG/K31	6.0	2.5	7.3	2824	50	F160SG152(1)250(2)	MMC7.3152(1)250K31(2)
250	160	0.0018	SG/K31	6.0	2.5	7.3	2824	50	F160SG182(1)250(2)	MMC7.3182(1)250K31(2)
250	160	0.0022	SG/K31	6.0	2.5	7.3	2824	50	F160SG222(1)250(2)	MMC7.3222(1)250K31(2)
250	160	0.0027	SG/K31	6.0	2.5	7.3	2824	50	F160SG272(1)250(2)	MMC7.3272(1)250K31(2)
250	160	0.0033	SG/K31	6.0	2.5	7.3	2824	50	F160SG332(1)250(2)	MMC7.3332(1)250K31(2)
250	160	0.0039	SG/K31	6.0	2.5	7.3	2824	50	F160SG392(1)250(2)	MMC7.3392(1)250K31(2)
250	160	0.0047	SG/K31	6.0	2.5	7.3	2824	50	F160SG472(1)250(2)	MMC7.3472(1)250K31(2)
250	160	0.0056	SG/K31	6.0	2.5	7.3	2824	50	F160SG562(1)250(2)	MMC7.3562(1)250K31(2)
250	160	0.0068	SG/K31	6.0	2.5	7.3	2824	40	F160SG682(1)250(2)	MMC7.3682(1)250K31(2)
250	160	0.0082	SG/K31	6.0	2.5	7.3	2824	40	F160SG822(1)250(2)	MMC7.3822(1)250K31(2)
250	160	0.010	SG/K31	6.0	2.5	7.3	2824	40	F160SG103(1)250(2)	MMC7.3103(1)250K31(2)
250	160	0.012	SG/K31	6.0	2.5	7.3	2824	40	F160SG123(1)250(2)	MMC7.3123(1)250K31(2)
250	160	0.015	SG/K31	6.0	2.5	7.3	2824	40	F160SG153(1)250(2)	MMC7.3153(1)250K31(2)
250	160	0.018	SL/K33	6.0	3.0	7.3	2824	40	F160SL183(1)250(2)	MMC7.3183(1)250K33(2)
250	160	0.022	SL/K33	6.0	3.0	7.3	2824	40	F160SL223(1)250(2)	MMC7.3223(1)250K33(2)
250	160	0.027	SP/K35	6.0	3.5	7.3	2824	40	F160SP273(1)250(2)	MMC7.3273(1)250K35(2)
250	160	0.033	SP/K35	6.0	3.5	7.3	2824	40	F160SP333(1)250(2)	MMC7.3333(1)250K35(2)
250	160	0.039	SP/K35	6.0	3.5	7.3	2824	40	F160SP393(1)250(2)	MMC7.3393(1)250K35(2)
250	160	0.047	ST/K37	6.0	4.5	7.3	2824	40	F160ST473(1)250(2)	MMC7.3473(1)250K37(2)
250	160	0.022	WP/A31	9.1	5.5	10.2	4036	40	F160WP223(1)250(2)	MMC10.2223(1)250A31(2)
250	160	0.027	WP/A31	9.1	5.5	10.2	4036	40	F160WP273(1)250(2)	MMC10.2273(1)250A31(2)
250	160	0.033	WP/A31	9.1	5.5	10.2	4036	40	F160WP333(1)250(2)	MMC10.2333(1)250A31(2)
250	160	0.039	WP/A31	9.1	5.5	10.2	4036	40	F160WP393(1)250(2)	MMC10.2393(1)250A31(2)
250	160	0.047	WP/A31	9.1	5.5	10.2	4036	40	F160WP473(1)250(2)	MMC10.2473(1)250A31(2)
250	160	0.056	WP/A31	9.1	5.5	10.2	4036	40	F160WP563(1)250(2)	MMC10.2563(1)250A31(2)
250	160	0.068	WP/A31	9.1	5.5	10.2	4036	40	F160WP683(1)250(2)	MMC10.2683(1)250A31(2)
250	160	0.082	WP/A31	9.1	5.5	10.2	4036	40	F160WP823(1)250(2)	MMC10.2823(1)250A31(2)
250	160	0.10	WP/A31	9.1	5.5	10.2	4036	30	F160WP104(1)250(2)	MMC10.2104(1)250A31(2)
250	160	0.12	WP/A31	9.1	5.5	10.2	4036	30	F160WP124(1)250(2)	MMC10.2124(1)250A31(2)
250	160	0.15	WP/A31	9.1	5.5	10.2	4036	30	F160WP154(1)250(2)	MMC10.2154(1)250A31(2)
250	160	0.18	YR/B31	11.5	6.5	12.7	5045	20	F160YR184(1)250(2)	MMC12.7184(1)250B31(2)
250	160	0.22	YR/B31	11.5	6.5	12.7	5045	20	F160YR224(1)250(2)	MMC12.7224(1)250B31(2)

(1) J = ±5%, K = ±10%, other tolerances on request.

(2) Insert ordering code for lead type and packaging. See Ordering Options Table for available options.

**Table 1 – Ratings & Part Number Reference cont'd**

VDC	VAC	Cap Value ( $\mu$ F)	Size Code (New/Legacy)	Dimensions in mm			Chip Size	dV/dt (V/ $\mu$ s)	New KEMET Part Number	Legacy Part Number
				B	H	L				
250	160	0.27	YR/B31	11.5	6.5	12.7	5045	20	F160YR274(1)250(2)	MMC12.7274(1)250B31(2)
250	160	0.33	YR/B31	11.5	6.5	12.7	5045	20	F160YR334(1)250(2)	MMC12.7334(1)250B31(2)
250	160	0.39	YR/B31	11.5	6.5	12.7	5045	20	F160YR394(1)250(2)	MMC12.7394(1)250B31(2)
250	160	0.47	YR/B31	11.5	6.5	12.7	5045	20	F160YR474(1)250(2)	MMC12.7474(1)250B31(2)
250	160	0.56	ZS/C31	15.0	7.0	16.5	6560	12	F160ZS564(1)250(2)	MMC16.5564(1)250C31(2)
250	160	0.68	ZS/C31	15.0	7.0	16.5	6560	12	F160ZS684(1)250(2)	MMC16.5684(1)250C31(2)
250	160	0.82	ZS/C31	15.0	7.0	16.5	6560	12	F160ZS824(1)250(2)	MMC16.5824(1)250C31(2)
250	160	1.0	ZS/C31	15.0	7.0	16.5	6560	12	F160ZS105(1)250(2)	MMC16.5105(1)250C31(2)
400	200	0.0010	SG/K31	6.0	2.5	7.3	2824	50	F160SG102(1)400(2)	MMC7.3102(1)400K31(2)
400	200	0.0012	SG/K31	6.0	2.5	7.3	2824	50	F160SG122(1)400(2)	MMC7.3122(1)400K31(2)
400	200	0.0015	SG/K31	6.0	2.5	7.3	2824	50	F160SG152(1)400(2)	MMC7.3152(1)400K31(2)
400	200	0.0018	SG/K31	6.0	2.5	7.3	2824	50	F160SG182(1)400(2)	MMC7.3182(1)400K31(2)
400	200	0.0022	SG/K31	6.0	2.5	7.3	2824	50	F160SG222(1)400(2)	MMC7.3222(1)400K31(2)
400	200	0.0027	SG/K31	6.0	2.5	7.3	2824	50	F160SG272(1)400(2)	MMC7.3272(1)400K31(2)
400	200	0.0033	SG/K31	6.0	2.5	7.3	2824	50	F160SG332(1)400(2)	MMC7.3332(1)400K31(2)
400	200	0.0039	SG/K31	6.0	2.5	7.3	2824	50	F160SG392(1)400(2)	MMC7.3392(1)400K31(2)
400	200	0.0047	SG/K31	6.0	2.5	7.3	2824	50	F160SG472(1)400(2)	MMC7.3472(1)400K31(2)
400	200	0.0056	SL/K33	6.0	3.0	7.3	2824	50	F160SL562(1)400(2)	MMC7.3562(1)400K33(2)
400	200	0.0068	SL/K33	6.0	3.0	7.3	2824	50	F160SL682(1)400(2)	MMC7.3682(1)400K33(2)
400	200	0.0082	SL/K33	6.0	3.0	7.3	2824	50	F160SL822(1)400(2)	MMC7.3822(1)400K33(2)
400	200	0.010	SP/K35	6.0	3.5	7.3	2824	50	F160SP103(1)400(2)	MMC7.3103(1)400K35(2)
400	200	0.012	SP/K35	6.0	3.5	7.3	2824	50	F160SP123(1)400(2)	MMC7.3123(1)400K35(2)
400	200	0.015	ST/K37	6.0	4.5	7.3	2824	50	F160ST153(1)400(2)	MMC7.3153(1)400K37(2)
400	200	0.022	WP/A31	9.1	5.5	10.2	4036	40	F160WP223(1)400(2)	MMC10.2223(1)400A31(2)
400	200	0.027	WP/A31	9.1	5.5	10.2	4036	40	F160WP273(1)400(2)	MMC10.2273(1)400A31(2)
400	200	0.033	WP/A31	9.1	5.5	10.2	4036	40	F160WP333(1)400(2)	MMC10.2333(1)400A31(2)
400	200	0.039	WP/A31	9.1	5.5	10.2	4036	40	F160WP393(1)400(2)	MMC10.2393(1)400A31(2)
400	200	0.047	WP/A31	9.1	5.5	10.2	4036	40	F160WP473(1)400(2)	MMC10.2473(1)400A31(2)
400	200	0.056	WP/A31	9.1	5.5	10.2	4036	40	F160WP563(1)400(2)	MMC10.2563(1)400A31(2)
400	200	0.068	WP/A31	9.1	5.5	10.2	4036	40	F160WP683(1)400(2)	MMC10.2683(1)400A31(2)
400	200	0.082	YR/B31	11.5	6.5	12.7	5045	30	F160YR823(1)400(2)	MMC12.7823(1)400B31(2)
400	200	0.10	YR/B31	11.5	6.5	12.7	5045	30	F160YR104(1)400(2)	MMC12.7104(1)400B31(2)
400	200	0.12	YR/B31	11.5	6.5	12.7	5045	30	F160YR124(1)400(2)	MMC12.7124(1)400B31(2)
400	200	0.15	YR/B31	11.5	6.5	12.7	5045	30	F160YR154(1)400(2)	MMC12.7154(1)400B31(2)
400	200	0.18	ZS/C31	15.0	7.0	16.5	6560	20	F160ZS184(1)400(2)	MMC16.5184(1)400C31(2)
400	200	0.22	ZS/C31	15.0	7.0	16.5	6560	20	F160ZS224(1)400(2)	MMC16.5224(1)400C31(2)
400	200	0.27	ZS/C31	15.0	7.0	16.5	6560	20	F160ZS274(1)400(2)	MMC16.5274(1)400C31(2)
400	200	0.33	ZS/C31	15.0	7.0	16.5	6560	20	F160ZS334(1)400(2)	MMC16.5334(1)400C31(2)
400	200	0.39	ZS/C31	15.0	7.0	16.5	6560	20	F160ZS394(1)400(2)	MMC16.5394(1)400C31(2)
400	200	0.47	ZS/C31	15.0	7.0	16.5	6560	20	F160ZS474(1)400(2)	MMC16.5474(1)400C31(2)
VDC	VAC	Cap Value ( $\mu$ F)	Size Code (New/Legacy)	B (mm)	H (mm)	L (mm)	Chip Size	dV/dt (V/ $\mu$ s)	New KEMET Part Number	Legacy Part Number

(1) J =  $\pm$ 5%, K =  $\pm$ 10%, other tolerances on request.

(2) Insert ordering code for lead type and packaging. See Ordering Options Table for available options.

## Soldering Process

Reflow soldering temperature is measured on the top body surface of the component. Preheating temperature should be less than 170°C. The time above 217°C should be less than 50 seconds. The peak temperature must not exceed 240°C.

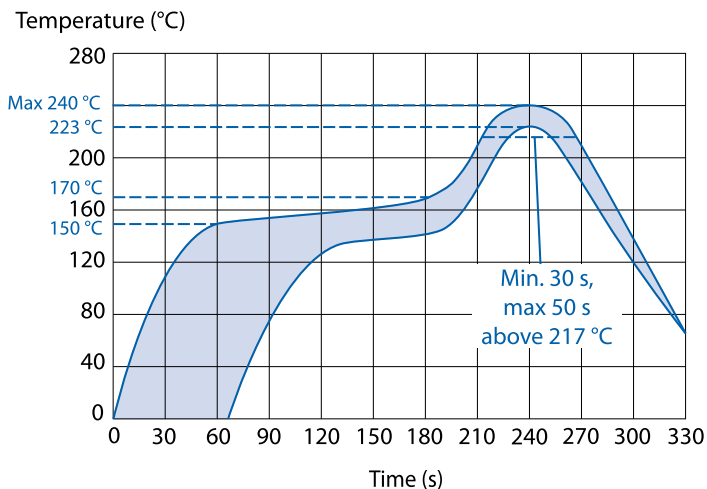

## Marking

- Capacitance
- Capacitance tolerance code
- Rated voltage code
- Capacitor type M for MMC
- Manufacturing date code

## Packaging Quantities

Chip Size (EIA)	Base (mm)	Height (mm)	Length (mm)	Bulk	Reel Horizontal Orientation	Reel Vertical Orientation
2220	5	2.5	5.7	2000	3100	
2220	5	3	5.7	2000	2400	
2220	5	4	5.7	2000	2100	
2824	6	2.5	7.3	2000	3100	
2824	6	3	7.3	2000	2500	
2824	6	3.5	7.3	2000	2300	
2824	6	4.5	7.3	1000	1700	
4036	9.1	5.5	10.2	1000	800	500
5045	11.5	6.5	12.7	1000	600	400
6560	15	7	16.5	800	500	200

## Carrier Taping & Packaging (IEC 60286–2)

### Horizontal Taping Orientation

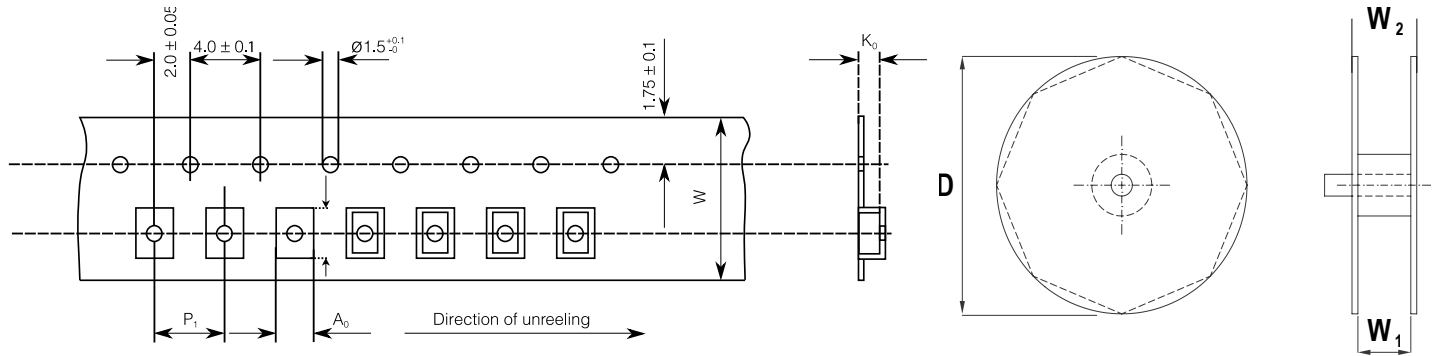

EIA Size Code Horizontal Mounting	Dimensions in mm			Taping Specification							
	B	H	L	W	P <sub>1</sub>	A <sub>0</sub>	B <sub>0</sub>	K <sub>0</sub>	D	W <sub>1</sub>	W <sub>2</sub>
	Nominal	Nominal	Nominal	-0/+0.3	+/-0.1	Nominal	Nominal	Nominal	-/+2.0	-0/+2	Maximum
2220	5.0	2.5	5.7	12.0	8.0	5.5	6.0	2.8	330	12.4	22.0
2220	5.0	3.0	5.7	12.0	8.0	5.5	6.0	3.3	330	12.4	22.0
2220	5.0	4.0	5.7	12.0	8.0	5.5	6.0	4.3	330	12.4	22.0
2824	6.0	2.5	7.3	12.0	8.0	6.5	7.5	2.8	330	12.4	22.0
2824	6.0	3.0	7.3	12.0	8.0	6.5	7.5	3.3	330	12.4	22.0
2824	6.0	3.5	7.3	12.0	8.0	6.5	7.5	3.8	330	12.4	22.0
2824	6.0	4.5	7.3	12.0	8.0	6.5	7.5	4.8	330	12.4	22.0
4036	9.1	5.5	10.2	16.0	16.0	9.5	10.5	5.8	330	16.4	22.0
5045	11.5	6.5	12.7	24.0	16.0	11.9	13.1	6.8	330	24.4	30.0
6560	15.0	7.0	16.5	24.0	20.0	15.4	16.8	7.3	330	24.4	30.0

## Carrier Taping & Packaging (IEC 60286–2) cont'd

### Vertical Taping Orientation

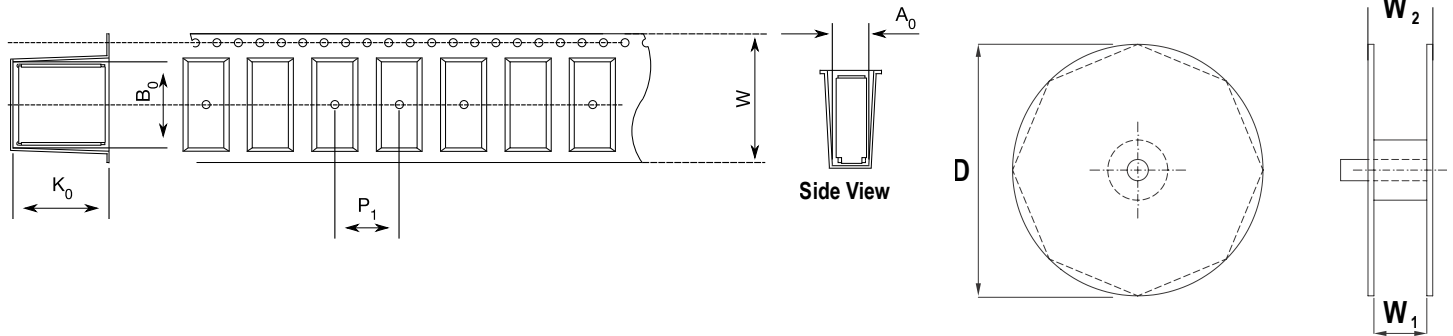

Size Code Vertical Mounting	Dimensions in mm			Taping Specification							
	B	H	L	W	$P_1$	$A_0$	$B_0$	$K_0$	D	$W_1$	$W_2$
	Nominal	Nominal	Nominal	-0/+0.3	+/-0.1	Nominal	Nominal	Nominal	-/+2.0	-0/+2	Maximum
4022	5.5	9.1	10.2	24.0	16.0	6.0	10.5	9.3	330	24.4	30.0
5026	6.5	11.5	12.7	24.0	16.0	6.9	13.1	11.8	330	24.4	30.0
6528	7.0	15.0	16.5	44.0	20.0	7.5	17.0	15.3	330	44.5	49.5

**Note: Chip dimensions B and H correspond to dimensions H and B in the horizontal mounting table.**

## KEMET Corporation World Headquarters

2835 KEMET Way  
Simpsonville, SC 29681

Mailing Address:  
P.O. Box 5928  
Greenville, SC 29606

www.kemet.com  
Tel: 864-963-6300  
Fax: 864-963-6521

**Corporate Offices**  
Fort Lauderdale, FL  
Tel: 954-766-2800

## North America

**Southeast**  
Lake Mary, FL  
Tel: 407-855-8886

**Northeast**  
Wilmington, MA  
Tel: 978-658-1663

**Central**  
Novi, MI  
Tel: 248-994-1030

**West**  
Milpitas, CA  
Tel: 408-433-9950

**Mexico**  
Guadalajara, Jalisco  
Tel: 52-33-3123-2141

## Europe

**Southern Europe**  
Paris, France  
Tel: 33-1-4646-1006

Sasso Marconi, Italy  
Tel: 39-051-939111

**Central Europe**  
Landsberg, Germany  
Tel: 49-8191-3350800

Kamen, Germany  
Tel: 49-2307-438110

**Northern Europe**  
Bishop's Stortford, United Kingdom  
Tel: 44-1279-460122

Espoo, Finland  
Tel: 358-9-5406-5000

## Asia

**Northeast Asia**  
Hong Kong  
Tel: 852-2305-1168

Shenzhen, China  
Tel: 86-755-2518-1306

Beijing, China  
Tel: 86-10-5829-1711

Shanghai, China  
Tel: 86-21-6447-0707

Taipei, Taiwan  
Tel: 886-2-27528585

**Southeast Asia**  
Singapore  
Tel: 65-6586-1900

Penang, Malaysia  
Tel: 60-4-6430200

Bangalore, India  
Tel: 91-806-53-76817

*Note: KEMET reserves the right to modify minor details of internal and external construction at any time in the interest of product improvement. KEMET does not assume any responsibility for infringement that might result from the use of KEMET Capacitors in potential circuit designs. KEMET is a registered trademark of KEMET Electronics Corporation.*

# Not for new design. Use new F161 Series.

Film Capacitors

General Purpose, High Stability and AC Line EMI Suppression – MMC Series Encapsulated Winding, Size 2220 – 6560, 50 – 400 VDC



## Other KEMET Resources

Tools	
Resource	Location
Configure A Part: CapEdge	<a href="http://capacitoredge.kemet.com">http://capacitoredge.kemet.com</a>
SPICE & FIT Software	<a href="http://www.kemet.com/spice">http://www.kemet.com/spice</a>
Search Our FAQs: KnowledgeEdge	<a href="http://www.kemet.com/keask">http://www.kemet.com/keask</a>
Electrolytic LifeCalculator	<a href="http://www.kemet.com:8080/elc">http://www.kemet.com:8080/elc</a>

Product Information	
Resource	Location
Products	<a href="http://www.kemet.com/products">http://www.kemet.com/products</a>
Technical Resources (Including Soldering Techniques)	<a href="http://www.kemet.com/technicalpapers">http://www.kemet.com/technicalpapers</a>
RoHS Statement	<a href="http://www.kemet.com/rohs">http://www.kemet.com/rohs</a>
Quality Documents	<a href="http://www.kemet.com/qualitydocuments">http://www.kemet.com/qualitydocuments</a>

Product Request	
Resource	Location
Sample Request	<a href="http://www.kemet.com/sample">http://www.kemet.com/sample</a>
Engineering Kit Request	<a href="http://www.kemet.com/kits">http://www.kemet.com/kits</a>

Contact	
Resource	Location
Website	<a href="http://www.kemet.com">www.kemet.com</a>
Contact Us	<a href="http://www.kemet.com/contact">http://www.kemet.com/contact</a>
Investor Relations	<a href="http://www.kemet.com/ir">http://www.kemet.com/ir</a>
Call Us	1-877-MyKEMET
Twitter	<a href="http://twitter.com/kemetcapacitors">http://twitter.com/kemetcapacitors</a>

## Disclaimer

All product specifications, statements, information and data (collectively, the "Information") in this datasheet are subject to change. The customer is responsible for checking and verifying the extent to which the Information contained in this publication is applicable to an order at the time the order is placed.

All Information given herein is believed to be accurate and reliable, but it is presented without guarantee, warranty, or responsibility of any kind, expressed or implied.

Statements of suitability for certain applications are based on KEMET Electronics Corporation's ("KEMET") knowledge of typical operating conditions for such applications, but are not intended to constitute – and KEMET specifically disclaims – any warranty concerning suitability for a specific customer application or use. The Information is intended for use only by customers who have the requisite experience and capability to determine the correct products for their application. Any technical advice inferred from this Information or otherwise provided by KEMET with reference to the use of KEMET's products is given gratis, and KEMET assumes no obligation or liability for the advice given or results obtained.

Although KEMET designs and manufactures its products to the most stringent quality and safety standards, given the current state of the art, isolated component failures may still occur. Accordingly, customer applications which require a high degree of reliability or safety should employ suitable designs or other safeguards (such as installation of protective circuitry or redundancies) in order to ensure that the failure of an electrical component does not result in a risk of personal injury or property damage.

Although all product-related warnings, cautions and notes must be observed, the customer should not assume that all safety measures are indicated or that other measures may not be required.

# Not for new design. Use new F161 Series.

Film Capacitors

General Purpose, High Stability and AC Line EMI Suppression – MMC Series Encapsulated Winding, Size 2220 – 6560, 50 – 400 VDC

---

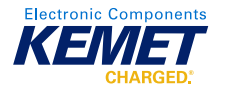



单击下面可查看定价，库存，交付和生命周期等信息

[>>KEMET\(基美\)](#)