

SMD Auto COG HV Flex, Ceramic, 0.018 uF, 5%, 1000 VDC, COG, SMD, MLCC, FT-CAP, Ultra-Stable, Automotive Grade, 1210

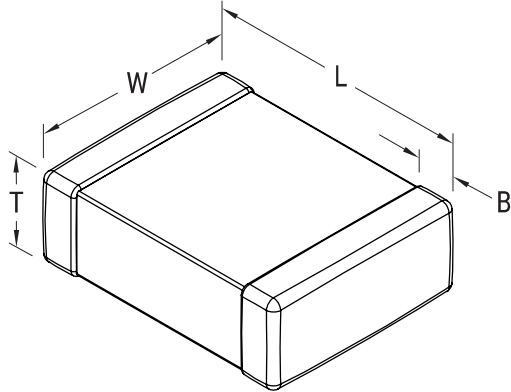

Dimensions	
Chip Size	1210
L	3.3mm +/-0.4mm
W	2.6mm +/-0.3mm
T	2.5mm +/-0.30mm
B	0.6mm +/-0.25mm

Packaging Specifications	
Packaging:	T&R, 330mm, Plastic Tape
Packaging Quantity:	4000

General Information	
Series:	SMD Auto COG HV Flex
Style:	SMD Chip
Description:	SMD, MLCC, FT-CAP, Ultra-Stable, Automotive Grade
Features:	FT-CAP, Ultra-Stable, Automotive Grade
RoHS:	Yes
Termination:	Flexible Termination
Marking:	No
Qualifications:	AEC-Q200
AEC-Q200:	Yes
Shelf Life:	78 Weeks
MSL:	1

Specifications	
Capacitance:	0.018 uF
Measurement Condition:	1 kHz 1.0Vrms
Capacitance Tolerance:	5%
Voltage DC:	1000 VDC
Dielectric Withstanding Voltage:	1200 VDC
Temperature Range:	-55/+125°C
Temperature Coefficient:	COG
Capacitance Change with Reference to +25°C and 0 VDC Applied (TCC):	30 ppm/C, 1kHz 1.0Vrms
Dissipation Factor:	0.1% 1kHz 1.0Vrms
Aging Rate:	0% Loss/Decade Hour
Insulation Resistance:	55.556 GOhms

Statements of suitability for certain applications are based on our knowledge of typical operating conditions for such applications, but are not intended to constitute - and we specifically disclaim - any warranty concerning suitability for a specific customer application or use. This Information is intended for use only by customers who have the requisite experience and capability to determine the correct products for their application. Any technical advice inferred from this Information or otherwise provided by us with reference to the use of our products is given gratis, and we assume no obligation or liability for the advice given or results obtained.

单击下面可查看定价，库存，交付和生命周期等信息

[>>KEMET\(基美\)](#)