

Straight Leads Diameter > 8
Lead and packaging code EA and KA

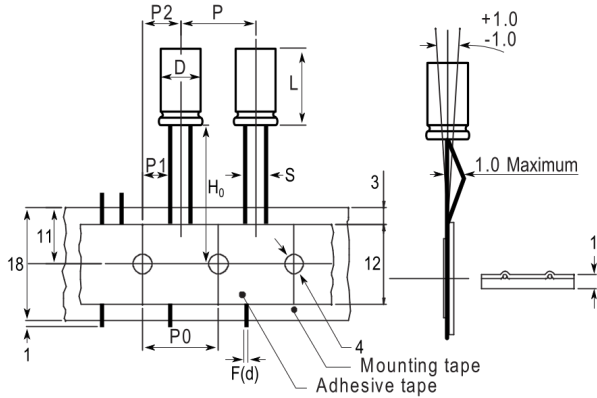

Note: '()' correspond to the letters used in the product bulletin

Click [here](#) for the 3D model.

Dimensions	
D	10mm +/-0.5mm
L	15mm +2mm
S	5mm +/-0.5mm
LL Negative	15mm MIN
LL Positive	20mm MIN
F	0.6mm NOM

Packaging Specifications	
Packaging	T&R
Packaging Quantity	600

General Information	
Series	ESC
Dielectric	Aluminum Electrolytic
Description	LowESR Single Ended Aluminum Electrolytic
Features	Low ESR
RoHS	Yes
Lead	Wire Leads
AEC-Q200	No

Specifications	
Capacitance	470 uF
Capacitance Tolerance	20%
Voltage DC	25 VDC, 32 VDC (Surge)
Temperature Range	-40/+105°C
Rated Temperature	105°C
Life	3000 Hrs
Dissipation Factor	10%
Resistance	0.064 Ohms (100kHz)
Ripple Current	1050 mAmps (100kHz 105C)
Leakage Current	117 uA (2min 20°C)
Impedance Ratio at -25C	3
Impedance Ratio at -40C	4

Statements of suitability for certain applications are based on our knowledge of typical operating conditions for such applications, but are not intended to constitute - and we specifically disclaim - any warranty concerning suitability for a specific customer application or use. This Information is intended for use only by customers who have the requisite experience and capability to determine the correct products for their application. Any technical advice inferred from this Information or otherwise provided by us with reference to the use of our products is given gratis, and we assume no obligation or liability for the advice given or results obtained.

单击下面可查看定价，库存，交付和生命周期等信息

[>>KEMET\(基美\)](#)