

## TRS1-0MCR01V

Aliases (USEC00MCR01000)

KEMET, TRS, Thermal Reed Switch, Axial, 2.5C Temperature Accuracy, High Reliability, High-Speed Response, Long Operational Life, Excellent Environmental Durability, High Temperature Accuracy, 0°C, Make

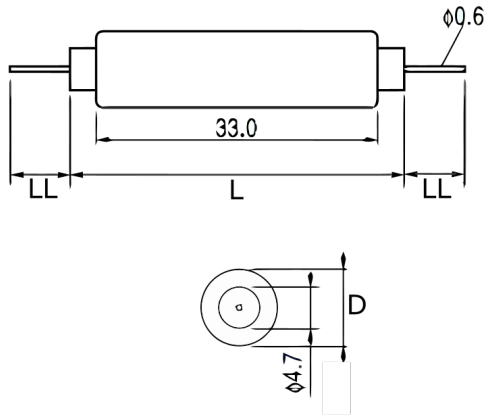

Click [here](#) for the 3D model.

### Dimensions

D	7mm NOM
L	40mm NOM
LL	8.5mm NOM

### Packaging Specifications

Packaging	Tray, Box
Packaging Quantity	600
Component Weight	3.4 g

### General Information

Series	TRS
Type	Thermal Reed Switch
Style	Axial
Description	Thermal Reed Switch
Features	High Reliability, High-Speed Response, Long Operational Life, Excellent Environmental Durability, High Temperature Accuracy
Lead	Wire Leads
RoHS	Yes

### Specifications

Switching Temperature	0C +/-2.5C
Temperature Range	-20/+130°C
Contact Type	Make
Voltage AC	220 VAC MAX (Opening/Closing)
Current	0.045 Amps AC MAX (Opening/Closing), 1 mAmps MIN (5VDC, Opening/Closing)
Resistance	150 mOhms MAX (Contact Resistance)
Max Opening/Closing Power	10 W (AC)
Max Opening/Closing Voltage	220 V (AC)
Differential Temperature	10C Maximum

单击下面可查看定价，库存，交付和生命周期等信息

[>>KEMET\(基美\)](#)