

SMD Comm COG SnPb, Ceramic, 1000 pF, 10%, 200 VDC, COG, SMD, MLCC, Ultra-Stable, Low Loss, Class I, 1206

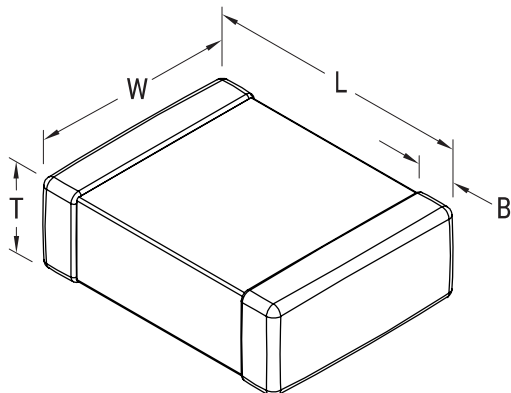

Dimensions	
Chip Size	1206
L	3.2mm +/-0.2mm
W	1.6mm +/-0.2mm
T	0.78mm +/-0.10mm
B	0.5mm +/-0.25mm

Packaging Specifications	
Packaging:	Bulk, Bag
Packaging Quantity:	1

General Information	
Series:	SMD Comm COG SnPb
Style:	SMD Chip
Description:	SMD, MLCC, Ultra-Stable, Low Loss, Class I
Features:	Ultra-Stable, Low Loss, Class I
RoHS:	No
Prop 65:	WARNING: Cancer and reproductive harm - www.p65warnings.ca.gov .
SCIP Number:	5549986b-60cf-4a2a-afbb-4ad1d7a11dcb
Termination:	Lead (SnPb)
Marking:	No
AEC-Q200:	No
Component Weight:	15 mg
Shelf Life:	78 Weeks
MSL:	1

Specifications	
Capacitance:	1000 pF
Measurement Condition:	1 MHz 1.0Vrms
Capacitance Tolerance:	10%
Voltage DC:	200 VDC
Dielectric Withstanding Voltage:	500 VDC
Temperature Range:	-55/+125°C
Temperature Coefficient:	COG
Capacitance Change with Reference to +25°C and 0 VDC Applied (TCC):	30 ppm/C, 1MegaHz 1.0Vrms
Dissipation Factor:	0.1% 1 MHz 1.0Vrms
Aging Rate:	0% Loss/Decade Hour
Insulation Resistance:	100 GOhms

Statements of suitability for certain applications are based on our knowledge of typical operating conditions for such applications, but are not intended to constitute - and we specifically disclaim - any warranty concerning suitability for a specific customer application or use. This Information is intended for use only by customers who have the requisite experience and capability to determine the correct products for their application. Any technical advice inferred from this Information or otherwise provided by us with reference to the use of our products is given gratis, and we assume no obligation or liability for the advice given or results obtained.

单击下面可查看定价，库存，交付和生命周期等信息

[>>KEMET\(基美\)](#)

[>>点击查看相关商品](#)