

T530, Tantalum, Polymer Tantalum, Multi-Anode, 220 uF, 20%, 10 VDC, SMD, Polymer, Molded, Multiple Anodes, Low ESR, 6 mOhms, 7343, Height Max = 4mm

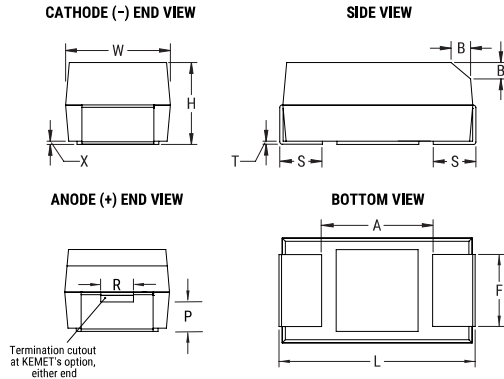

Dimensions	
Footprint	7343
L	7.3mm +/-0.3mm
W	4.3mm +/-0.3mm
H	3.8mm +/-0.2mm
T	0.13mm REF
S	1.3mm +/-0.3mm
F	2.4mm +/-0.1mm
A	3.8mm MIN
B	0.5mm +/-0.15mm
P	1.7mm REF
R	1mm REF
X	0.1mm +/-0.1mm

Packaging Specifications	
Packaging:	T&R, 178mm
Packaging Quantity:	500

General Information	
Series:	T530
Dielectric:	Polymer Tantalum
Style:	SMD Chip
Description:	SMD, Polymer, Molded, Multiple Anodes, Low ESR
Features:	Low ESR
RoHS:	No
Prop 65:	WARNING: Cancer and reproductive harm - www.p65warnings.ca.gov
SCIP Number:	b064b03e-bd75-42af-b342-1fe94dec2340
Termination:	Solder Coated
AEC-Q200:	No
Component Weight:	378.06 mg
Shelf Life:	52 Weeks
MSL:	3

Specifications	
Capacitance:	220 uF
Capacitance Tolerance:	20%
Voltage DC:	10 VDC (105C), 6.7 VDC (125C)
Temperature Range:	-55/+125°C
Rated Temperature:	105°C
Life:	2000 Hrs (125C)
Humidity:	60C, 90% RH, 1000 Hours, No Load
Dissipation Factor:	8% 120Hz 25C
Failure Rate:	N/A
Resistance:	6 mOhms (100kHz 25C)
Ripple Current:	6600 mA (rms, 100kHz 45C), 4620 mA (rms, 85C), 1650 mA (rms, 125C)
Leakage Current:	220 uA (5min 25°C)

Statements of suitability for certain applications are based on our knowledge of typical operating conditions for such applications, but are not intended to constitute - and we specifically disclaim - any warranty concerning suitability for a specific customer application or use. This Information is intended for use only by customers who have the requisite experience and capability to determine the correct products for their application. Any technical advice inferred from this Information or otherwise provided by us with reference to the use of our products is given gratis, and we assume no obligation or liability for the advice given or results obtained.

单击下面可查看定价，库存，交付和生命周期等信息

[>>KEMET\(基美\)](#)