

## Overview

The SR series of filters are typically designed for use in shielded, compartment-type screened rooms, secure communications areas, and MRI screened facilities. All models are manufactured to the industry standard performance range and are of high quality, robust construction. Each filter is designed for direct mounting through the wall of a room, bulkhead, or cabinet via a threaded mounting pipe.

- Current ratings from 1A to 100A
- Industry standard high attenuation performance
- Direct mounting via pipe outlet
- Robust, quality construction
- 30A to 100A models can also be used in multiples for 3 phase and 3 phase + neutral applications

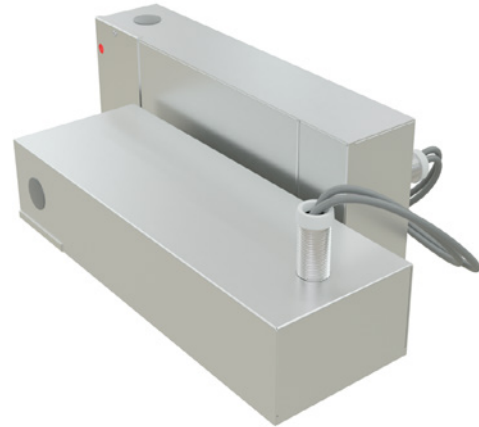

## Technical Specifications

Item	Parameters/Characteristics
Rated Voltage	250 - 480 VAC
Rated Current	1 - 100 A
Rated Temperature	40°C
Temperature range	-25°C to 85°C
Climate Category	25/085/21
Voltage test	L → L 1,700 VDC L → PE 2,700 VDC

Typical Electrical Schematic: 1 - 5A SRW2

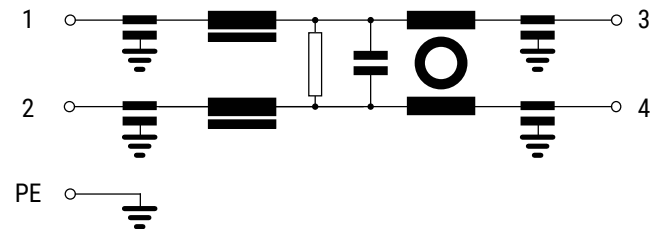

Part Number	Rated Voltage (VAC)	Rated Current (A)	Leakage Current (A)	C (μF)	RDC (mΩ)	Neons	Penetration Pipe	Termination	
								Line	Load Cables
FLLE2001ASRW2	250	1	0.002 @ 220 V	0.023	800	-	M25	Solder 1)	20 AWG x 450
FLLE2005ASRW2	250	5	0.002 @ 220 V	0.023	150	-	M25	Solder 2)	18 AWG x 450

NPSL = National Pipe Straight Locknut

1) Wiretag accepts 0.75 mm<sup>2</sup>

2) Wiretag accepts 1 mm<sup>2</sup>

## Technical Specifications cont.

Typical Electrical Schematic: 30A SRW2

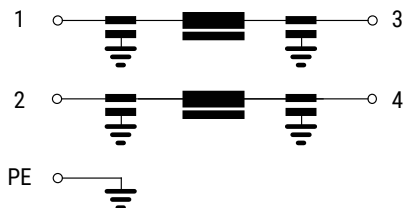

Typical Electrical Schematic: 30A SRW1

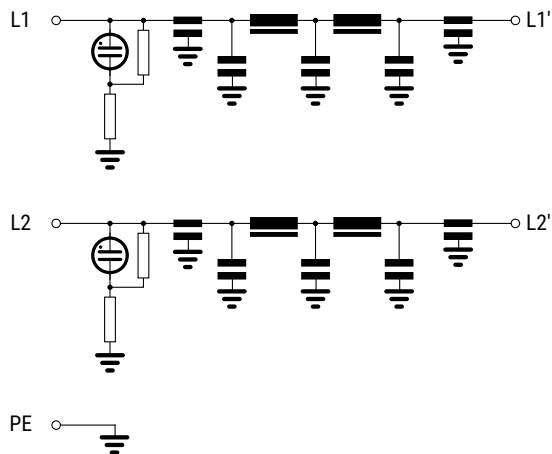

Typical Electrical Schematic: 60A SRW1

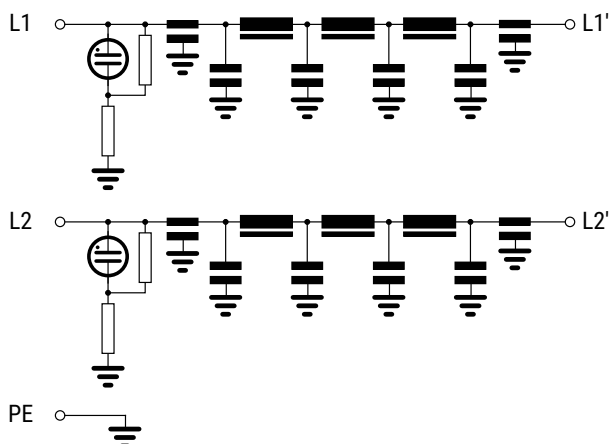

Typical Electrical Schematic: 100A SRW1

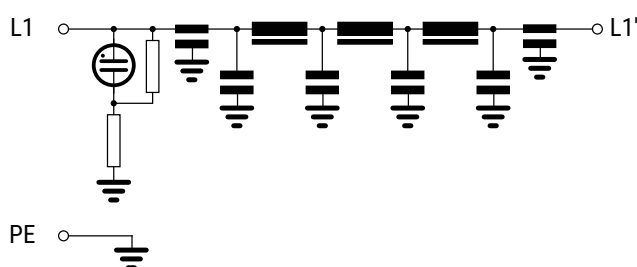

Part Number	Rated Voltage (VAC)	Rated Current (A)	Leakage Current (A)	C (μF)	RDC (mΩ)	Neons	Penetration Pipe	Termination	
								Line	Load Cables
FLLE2030ASRW2	250	30	0.183 @ 220 V	2	6	-	M25	M6	12 AWG x 500
FLLE2030ASRW1	480	30	2.29 @ 277 V	20	14	2	1" NPSL	M6	10 AWG x 700
FLLE2060ASRW1	480	60	2.29 @ 277 V	20	5.5	2	1" NPSL	M8	6 AWG x 700
FLLEU100ASRW1	277	100	4.96 @ 277 V	43.2	3.2	1	1" NPSL	M10	2 AWG x 700

NPSL = National Pipe Straight Locknut

1) Wiretag accepts 0.75 mm<sup>2</sup>

2) Wiretag accepts 1 mm<sup>2</sup>

## Approvals

Standard	Certification Body	File Number	
UL 1283, 5th Edition	UL	E192374	

## Environmental Compliance

KEMET EMI filters are RoHS Compliant.



## Mechanical Dimensions – Millimeters

SRW2

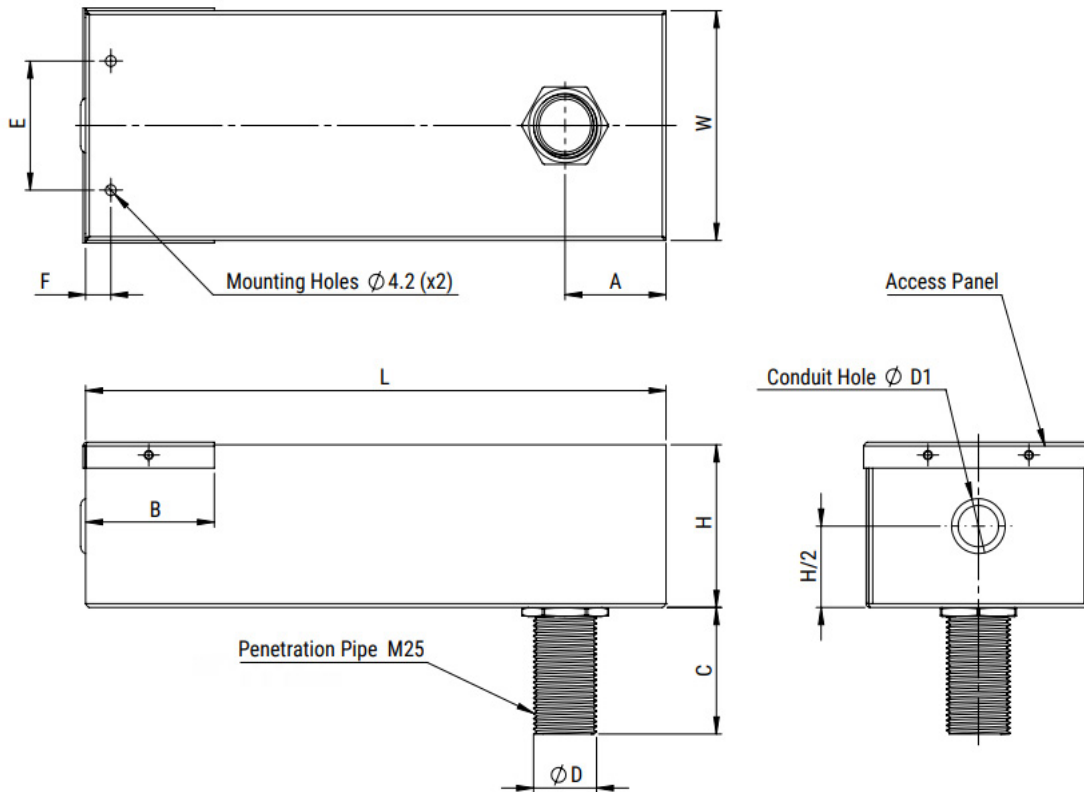

Part Number	Dimensions in mm									Thread
	W	H	A	B	C	Ø D	Ø D1	E	F	
FLLE2001ASRW2	89	93	40	51	50	25	20	50	10	M25
FLLE2005ASRW2	89	93	40	51	50	25	20	50	10	M25
FLLE2030ASRW2	125	115	40	62	50	25	20	100	10	M25

NPSL = National Pipe Straight Locknut

## Mechanical Dimensions – Millimeters cont.

SRW1

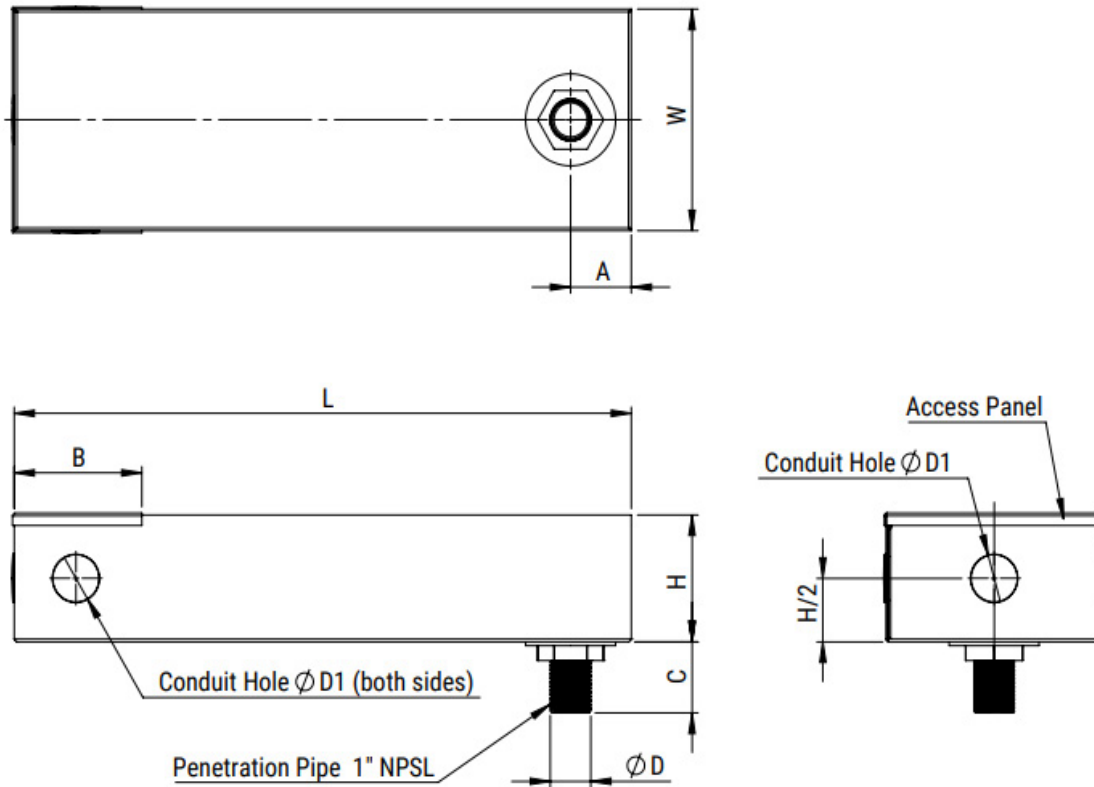

Part Number	Dimensions in mm								Thread	
	W	H	A	B	C	$\varnothing D$	$\varnothing D1$	E		F
FLLE2030ASRW1	180	105	51.5	102	57	34	35	-	-	1" NPSL
FLLE2060ASRW1	205	106	50	82	57	34	35	-	-	1" NPSL
FLLEU100ASRW1	115	115	50	107	57	34	35	-	-	1" NPSL

NPSL = National Pipe Straight Locknut

## Mounting Diagram

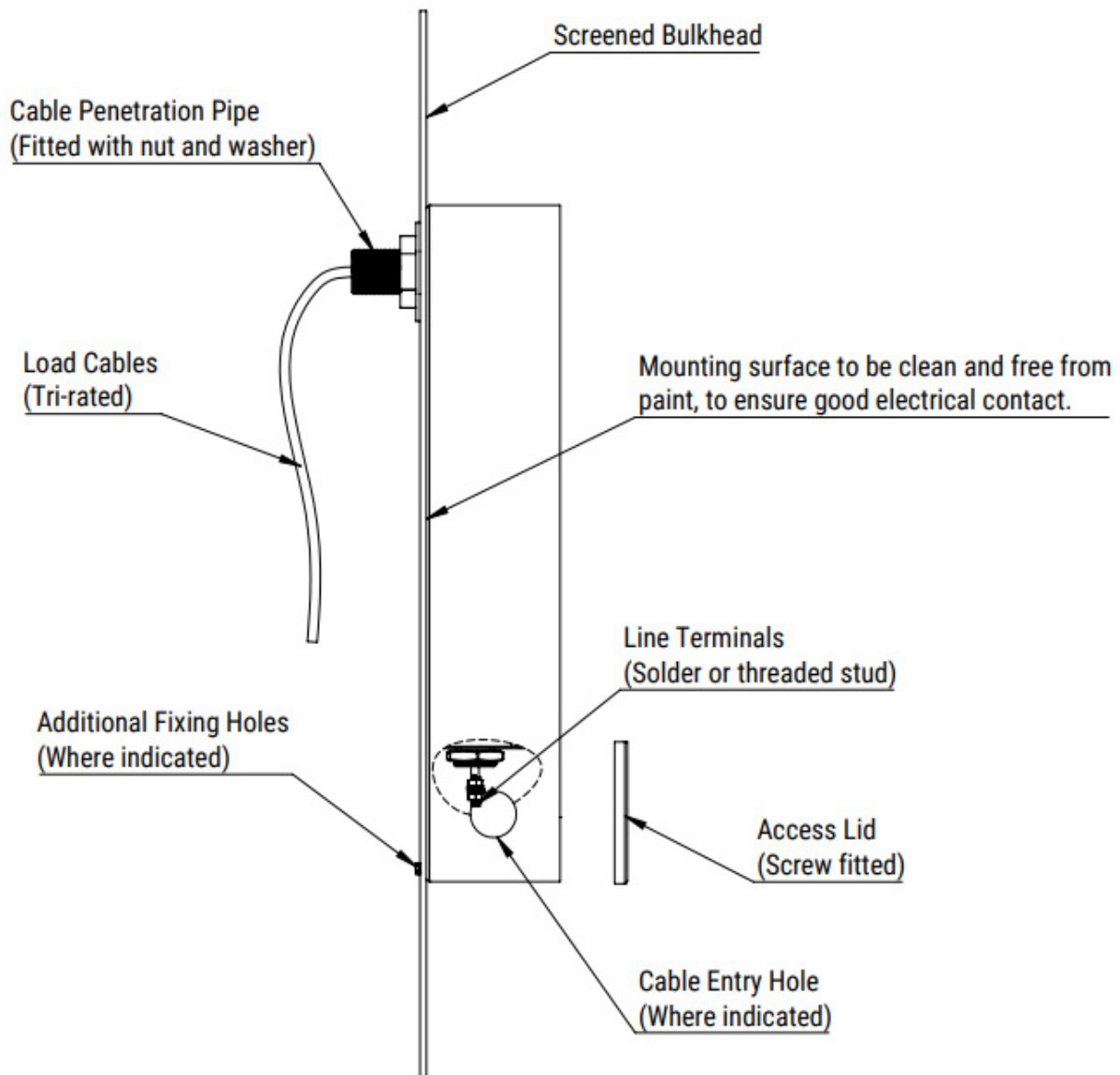

## KEMET Electronics Corporation Sales Offices

For a complete list of our global sales offices, please visit [www.kemet.com/sales](http://www.kemet.com/sales).

---

### Disclaimer

All product specifications, statements, information and data (collectively, the "Information") in this datasheet are subject to change. The customer is responsible for checking and verifying the extent to which the Information contained in this publication is applicable to an order at the time the order is placed. All Information given herein is believed to be accurate and reliable, but it is presented without guarantee, warranty, or responsibility of any kind, expressed or implied.

Statements of suitability for certain applications are based on KEMET Electronics Corporation's ("KEMET") knowledge of typical operating conditions for such applications, but are not intended to constitute – and KEMET specifically disclaims – any warranty concerning suitability for a specific customer application or use. The Information is intended for use only by customers who have the requisite experience and capability to determine the correct products for their application. Any technical advice inferred from this Information or otherwise provided by KEMET with reference to the use of KEMET's products is given gratis, and KEMET assumes no obligation or liability for the advice given or results obtained.

Although KEMET designs and manufactures its products to the most stringent quality and safety standards, given the current state of the art, isolated component failures may still occur. Accordingly, customer applications which require a high degree of reliability or safety should employ suitable designs or other safeguards (such as installation of protective circuitry or redundancies) in order to ensure that the failure of an electrical component does not result in a risk of personal injury or property damage.

Although all product-related warnings, cautions and notes must be observed, the customer should not assume that all safety measures are indicated or that other measures may not be required.

*KEMET is a registered trademark of KEMET Electronics Corporation.*

单击下面可查看定价，库存，交付和生命周期等信息

[>>KEMET\(基美\)](#)