

ALA7D, Aluminum Electrolytic, 470 uF, 20%, 550 VDC, -40/+85°C

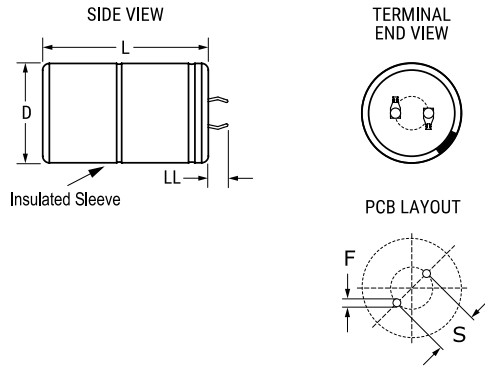

Dimensions	
D	40mm +1mm
L	45mm +/-2mm
S	10mm +/-0.1mm
LL	6.3mm +/-1mm
F	2mm +/-0.1mm

Packaging Specifications	
Packaging:	Bulk, Bag
Packaging Quantity:	72

General Information	
Series:	ALA7D
Dielectric:	Aluminum Electrolytic
Description:	Snap-In, Aluminum Electrolytic
RoHS:	Yes
Lead:	2 Pin
Qualifications:	AEC-Q200
AEC-Q200:	Yes
Halogen Free:	Yes
Component Weight:	95 g
Miscellaneous:	Vibration: <= 35mm 1.5mm displacement amplitude or 20G maximum acceleration. Vibration applied for three directions of 4-hour sessions at 10-2,000 Hz. (Capacitor clamped by body.)
Shelf Life:	156 Weeks

Specifications	
Capacitance:	470 uF
Capacitance Tolerance:	20%
Voltage DC:	550 VDC, 605 VDC (Surge)
Temperature Range:	-40/+85°C
Rated Temperature:	85°C
Life:	18000 Hrs (Rated Voltage And Ripple Current At 85C), 29000 Hrs (Rated Voltage At 105C)
Resistance:	375 mOhms (100Hz 20C), 261 mOhms (10kHz 20C)
Ripple Current:	2.829 Amps (100Hz 85C), 5.5 Amps (10kHz 85C)
Leakage Current:	1551 uA (5min 20°C)

Statements of suitability for certain applications are based on our knowledge of typical operating conditions for such applications, but are not intended to constitute - and we specifically disclaim - any warranty concerning suitability for a specific customer application or use. This Information is intended for use only by customers who have the requisite experience and capability to determine the correct products for their application. Any technical advice inferred from this Information or otherwise provided by us with reference to the use of our products is given gratis, and we assume no obligation or liability for the advice given or results obtained.

单击下面可查看定价，库存，交付和生命周期等信息

[>>KEMET\(基美\)](#)