

KEMET Part Number: SMR7.5472K250K01L4BULK
(F211KG472K250C)

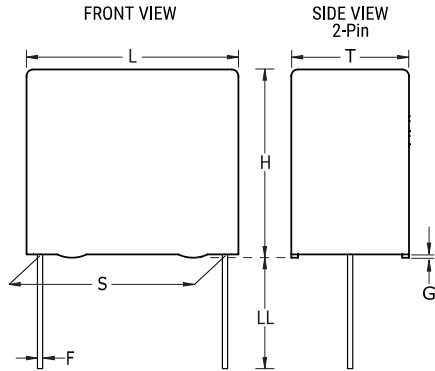

SMR/F211, Film, Metallized PPS, General Purpose, 4700 pF, 10%, 250 VDC, 125°C, Lead Spacing = 7.5mm



General Information	
Series:	SMR/F211
Dielectric:	Metallized PPS
Style:	Radial
Features:	Audio Applications
RoHS:	Yes
Lead:	Wire Leads
AEC-Q200:	No
Miscellaneous:	The rated voltage decreases 2%/C between +125C and +150C.
Notes:	Case Size = KG.

Dimensions	
L	10mm -0.5mm
H	8mm -0.5mm
T	4mm -0.5mm
S	7.5mm +/-0.4mm
LL	4mm +1mm
F	0.6mm +/-0.05mm
G	0.5mm NOM

Specifications	
Capacitance:	4700 pF
Capacitance Tolerance:	10%
Voltage AC:	160 VAC
Voltage DC:	250 VDC
Temperature Range:	-55/+150°C
Rated Temperature:	125°C
Dissipation Factor:	0.15% 1kHz, 0.25% 10kHz, 0.6% 100kHz
Insulation Resistance:	30 GOhms
Max dV/dt:	30 V/us

Packaging Specifications	
Packaging:	Bulk, Bag
Packaging Quantity:	1000

Statements of suitability for certain applications are based on our knowledge of typical operating conditions for such applications, but are not intended to constitute - and we specifically disclaim - any warranty concerning suitability for a specific customer application or use. This Information is intended for use only by customers who have the requisite experience and capability to determine the correct products for their application. Any technical advice inferred from this Information or otherwise provided by us with reference to the use of our products is given gratis, and we assume no obligation or liability for the advice given or results obtained.



单击下面可查看定价，库存，交付和生命周期等信息

[>>KEMET\(基美\)](#)