

ELH, Aluminum Electrolytic, 4,700 uF, 20%, 80 VDC, -40/+85°C

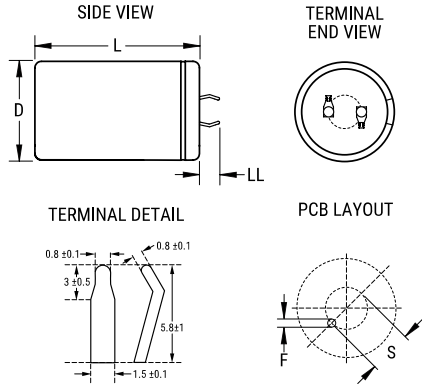

**Dimensions**

<b>D</b>	25mm +1mm
<b>L</b>	50mm +2mm
<b>S</b>	10mm +/-0.5mm
<b>LL</b>	4mm +/-1mm
<b>F</b>	1.5mm +/-0.1mm

**Packaging Specifications**

<b>Packaging:</b>	Bulk, Bag
<b>Packaging Quantity:</b>	200

**General Information**

<b>Series:</b>	ELH
<b>Dielectric:</b>	Aluminum Electrolytic
<b>Description:</b>	Snap-In, Aluminum Electrolytic
<b>RoHS:</b>	Yes
<b>Lead:</b>	2 Pin
<b>AEC-Q200:</b>	No

**Specifications**

<b>Capacitance:</b>	4,700 uF
<b>Capacitance Tolerance:</b>	20%
<b>Voltage DC:</b>	80 VDC, 100 VDC (Surge)
<b>Temperature Range:</b>	-40/+85°C
<b>Rated Temperature:</b>	85°C
<b>Life:</b>	2000 Hrs
<b>Dissipation Factor:</b>	25% 120Hz 20C
<b>Ripple Current:</b>	4050 mAmps (120Hz)
<b>Leakage Current:</b>	3000 uA (5min 20°C)

Statements of suitability for certain applications are based on our knowledge of typical operating conditions for such applications, but are not intended to constitute - and we specifically disclaim - any warranty concerning suitability for a specific customer application or use. This Information is intended for use only by customers who have the requisite experience and capability to determine the correct products for their application. Any technical advice inferred from this Information or otherwise provided by us with reference to the use of our products is given gratis, and we assume no obligation or liability for the advice given or results obtained.

单击下面可查看定价，库存，交付和生命周期等信息

[>>KEMET\(基美\)](#)