

KEMET Part Number: SM25B474K102B
(SM25B474K102)

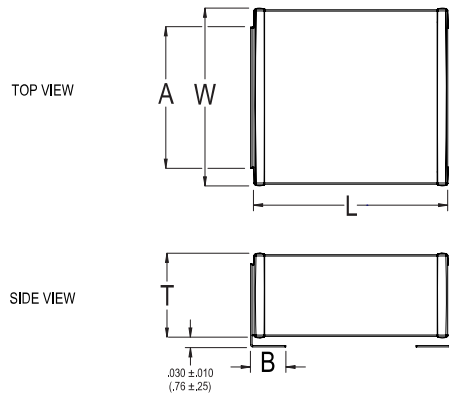

KPS SM SMD Indust X7R HV, Ceramic, 0.47 uF, 10%, 1000 VDC, X7R, SMD, Fixed, High Volt, Low ESR, Leaded, Industrial, SM25



Dimensions	
Chip Size	SM25
L	13.97mm +/-0.762mm
W	12.7mm +/-0.762mm
T	5.588mm MAX
A	10.2mm MAX
B	2.54mm +/-0.508mm

Packaging Specifications	
Packaging:	Tray
Packaging Quantity:	50

General Information	
Series:	KPS SM SMD Indust X7R HV
Style:	SMD Chip
Description:	SMD, Fixed, High Volt, Low ESR, Leaded, Industrial
Features:	High Voltage, Low ESR, Industrial Grade
RoHS:	With Exemptions
REACH:	SVHC (Pb – CAS 7439-92-1)
Termination:	Silver
Marking:	No
AEC-Q200:	No
Shelf Life:	78 Weeks
MSL:	1

Specifications	
Capacitance:	0.47 uF
Capacitance Tolerance:	10%
Voltage DC:	1000 VDC
Dielectric Withstanding Voltage:	1500 VDC
Temperature Range:	-55/+125°C
Temperature Coefficient:	X7R
Dissipation Factor:	2.5%
Insulation Resistance:	2.1 GOhms
Quality Factor:	3

Statements of suitability for certain applications are based on our knowledge of typical operating conditions for such applications, but are not intended to constitute - and we specifically disclaim - any warranty concerning suitability for a specific customer application or use. This Information is intended for use only by customers who have the requisite experience and capability to determine the correct products for their application. Any technical advice inferred from this Information or otherwise provided by us with reference to the use of our products is given gratis, and we assume no obligation or liability for the advice given or results obtained.



单击下面可查看定价，库存，交付和生命周期等信息

[>>KEMET\(基美\)](#)