

ALC40, Aluminum Electrolytic, 330 uF, 20%, 450 VDC, -40/+105°C

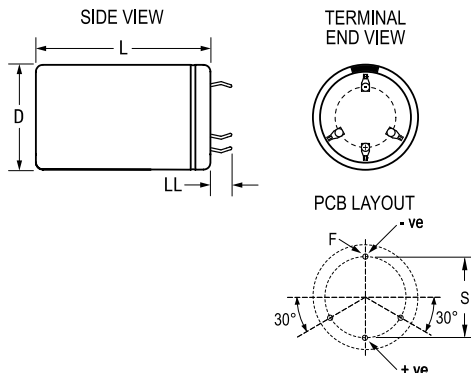

Dimensions	
D	40mm +1mm
L	55mm +/-2mm
S	22.5mm +/-0.1mm
LL	4mm +/-1mm
F	2mm +/-0.1mm

Packaging Specifications	
Packaging:	Bulk, Bag

General Information	
Series:	ALC40
Dielectric:	Aluminum Electrolytic
Description:	Snap-In, Aluminum Electrolytic
RoHS:	Yes
Lead:	4 Pin Short
AEC-Q200:	No
Component Weight:	95 g
Shelf Life:	156 Weeks

Specifications	
Capacitance:	330 uF
Capacitance Tolerance:	20%
Voltage DC:	450 VDC, 495 VDC (Surge)
Temperature Range:	-40/+105°C
Rated Temperature:	105°C
Life:	9000 Hrs (Rated Voltage And Ripple Current At 105C), 14000 Hrs (Rated Voltage at 105C)
Resistance:	293 mOhms (100Hz 20C), 204 mOhms (10kHz 20C)
Ripple Current:	3.14 Amps (100Hz 105C), 7.29 Amps (10kHz 105C)
Leakage Current:	445.5 uA (5min 20°C)

Statements of suitability for certain applications are based on our knowledge of typical operating conditions for such applications, but are not intended to constitute - and we specifically disclaim - any warranty concerning suitability for a specific customer application or use. This Information is intended for use only by customers who have the requisite experience and capability to determine the correct products for their application. Any technical advice inferred from this Information or otherwise provided by us with reference to the use of our products is given gratis, and we assume no obligation or liability for the advice given or results obtained.

单击下面可查看定价，库存，交付和生命周期等信息

[>>KEMET\(基美\)](#)