

CAN SMD Indust 250, Ceramic, 430 pF, 2%, COG, SMD Chip, MLCC, AC Rated, 0603

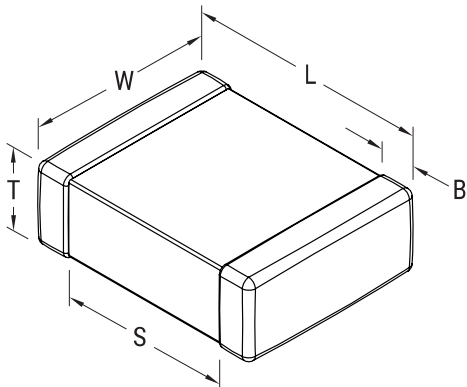

General Information	
Series:	CAN SMD Indust 250
Style:	SMD Chip
Description:	SMD Chip, MLCC, AC Rated
Features:	Temperature Stable, Class I
RoHS:	Yes
Termination:	Tin
Marking:	No
AEC-Q200:	No
MSL:	1

Dimensions	
Chip Size	0603
L	1.6mm +/-0.15mm
W	0.8mm +/-0.15mm
T	0.8mm +/-0.10mm
S	0.7mm MIN
B	0.35mm +/-0.15mm

Packaging Specifications	
Packaging:	Bulk, Bag
Packaging Quantity:	1

Specifications	
Capacitance:	430 pF
Measurement Condition:	1 MHz 1.0Vrms
Capacitance Tolerance:	2%
Voltage AC:	250 VAC
Dielectric Withstanding Voltage:	945 VDC
Temperature Range:	-55/+125°C
Temperature Coefficient:	COG
Capacitance Change with Reference to +25°C and 0 VDC Applied (TCC):	15%, 1MegaHz 1.0Vrms
Dissipation Factor:	0.1% 1 MHz 1.0Vrms
Aging Rate:	0% Loss/Decade Hour
Insulation Resistance:	10 GOhms

Statements of suitability for certain applications are based on our knowledge of typical operating conditions for such applications, but are not intended to constitute - and we specifically disclaim - any warranty concerning suitability for a specific customer application or use. This Information is intended for use only by customers who have the requisite experience and capability to determine the correct products for their application. Any technical advice inferred from this Information or otherwise provided by us with reference to the use of our products is given gratis, and we assume no obligation or liability for the advice given or results obtained.

单击下面可查看定价，库存，交付和生命周期等信息

[>>KEMET\(基美\)](#)