

TRS5-40BCR01

Aliases (USEE40BCR01000)

KEMET, TRS, Thermal Reed Switch, Axial, 2.5C Temperature Accuracy, High Reliability, High-Speed Response, Long Operational Life, Excellent Environmental Durability, High Temperature Accuracy, 40°C, Break

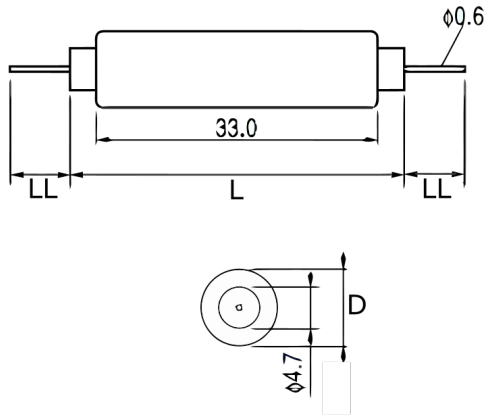

Click [here](#) for the 3D model.

Dimensions

D	7mm NOM
L	40mm NOM
LL	8.5mm NOM

Packaging Specifications

Packaging	Tray, Box
Packaging Quantity	600
Component Weight	3.1g

General Information

Series	TRS
Type	Thermal Reed Switch
Style	Axial
Description	Thermal Reed Switch
Features	High Reliability, High-Speed Response, Long Operational Life, Excellent Environmental Durability, High Temperature Accuracy
Lead	Wire Leads
RoHS	Yes

Specifications

Switching Temperature	40C +/-2.5C
Temperature Range	-20/+130°C
Contact Type	Break
Voltage DC	200 VDC MAX (Opening/Closing), 1500 VAC/1 minute or 1800 VAC/1 second
Voltage AC	140 VAC MAX (Opening/Closing)
Current	0.55 Amps AC/DC MAX (Opening/Closing), 1 mAmps MIN (5VDC, Opening/Closing)
Resistance	150 mOhms MAX (Contact Resistance)
Max Opening/Closing Power	60.5 W (AC/DC); 10 W (DC)
Max Opening/Closing Voltage	140 V (AC); 200 V (DC)
Differential Temperature	10C Maximum

单击下面可查看定价，库存，交付和生命周期等信息

[>>KEMET\(基美\)](#)