

F43 Metallized Polypropylene RC Snubber Film, 160 – 220 VAC/250 – 630 VDC; 275 VAC Class X2

Overview

The F43 is constructed of metallized polypropylene film encapsulated with self-extinguishing resin in a box of material that meets the requirements of UL 94 V-0.

Applications

Typical applications include worldwide use in contact protection, contact interference suppression, and transient suppression.

Benefits

- Approvals (for 275 VAC only): ENEC, UL
- Rated voltage: 160 VAC/250 VDC, 200 VAC/400 VDC, 220 VAC/630 VDC, 275 VAC Class X2
- Capacitance range: 0.01 – 1.0 μ F
- Lead spacing: 15.0 – 27.5 mm
- Capacitance tolerance: \pm 20%, \pm 10%
- Resistance range: 22 – 470 Ω
- Resistance tolerance: \pm 10%
- Resistance power: 0.5 W
- Climatic category: 55/100/56, IEC 60068-1 and 40/100/56 (275 VAC), IEC 60068-1
- Tape & Reel packaging in accordance with IEC 60286-2
- RoHS compliance and lead (Pb)-free terminations
- Operating temperature range: -55°C to $+100^{\circ}\text{C}$ and -40°C to $+100^{\circ}\text{C}$ (275 VAC)

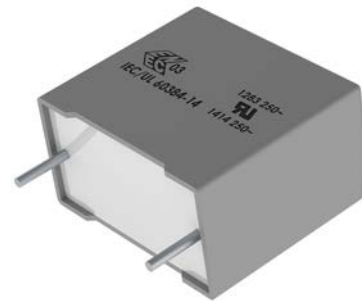

Part Number System

| F | 43 | K | N | 3100 | XX | 01 | K | R101 |
|---|--|---|----------------------------------|---|--|-----------------------|--------------------------------|---|
| Capacitor Class | Series | Rated Voltage (VAC) | Lead Spacing (mm) | Capacitance Code (pF) | Packaging | Internal Use | Capacitance Tolerance | Resistance (Ω) |
| Legacy PN: F New KEMET PN: Omit this character | RC Snubber, Metallized Polypropylene | I = 160 M = 200 P = 220 K = 275 (X2) | I = 15.0 N = 22.5 R = 27.5 | The last three digits represent significant figures. The first digit specifies number of zeros to be added. | See Ordering Option Table. Contact KEMET for other packaging availability and details. | 00, 01, 04 (Standard) | K = \pm 10% M = \pm 20% | R plus first two digits represent significant figures. Third digit specifies number of zeros. |

Ordering Options Table

| Lead Spacing Nominal (mm) | Type of Leads and Packaging | Lead Length (mm) | Lead and Packaging Code |
|---------------------------------------|---|--------------------------|-------------------------|
| 15 22.5 27.5 | Standard Lead and Packaging Options | | |
| | Bulk (Bag) – Short leads | 4 +2/-0 | 00 |
| | Ammo Pack | $H_0 = 18.5 \pm 0.5$ | DQ |
| | Other Lead and Packaging Options | | |
| | Tape & Reel (Large Reel $\varnothing = 500$ mm) | $H_0 = 18.5 \pm 0.5$ | CK |
| | Bulk (Bag) – Long leads | 30 +5/-0 | 40 |
| | Bulk (Bag) – Long leads | 25 +2/-1 | 50 |
| | Bulk (Bag) – Insulated Rigid Leads | 30 +5/-0 (sp 8 ± 2) | 51 |
| Bulk (Bag) – Insulated Flexible Leads | 150 ± 5 (sp 8 ± 2) | 52 | |

Contact KEMET for availability and details for special leads or packing.

Dimensions – Millimeters

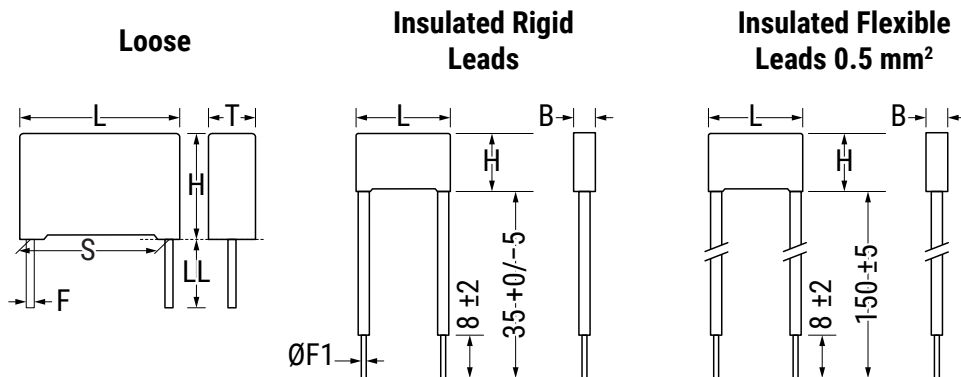

| S | | T | | H | | L | | F | | F1 | |
|---------|-----------|---------|-----------|---------|-----------|---------|-----------|---------|------------|---------|------------|
| Nominal | Tolerance | Nominal | Tolerance | Nominal | Tolerance | Nominal | Tolerance | Nominal | Tolerance | Nominal | Tolerance |
| 15.0 | ± 0.4 | 6.0 | +0.2 | 17.5 | +0.1 | 18.0 | +0.3 | 0.6 | ± 0.05 | 0.8 | ± 0.05 |
| 15.0 | ± 0.4 | 7.5 | +0.2 | 14.5 | +0.1 | 18.0 | +0.5 | 0.6 | ± 0.05 | 0.8 | ± 0.05 |
| 15.0 | ± 0.4 | 8.5 | +0.2 | 14.5 | +0.1 | 18.0 | +0.5 | 0.6 | ± 0.05 | 0.8 | ± 0.05 |
| 15.0 | ± 0.4 | 10.0 | +0.2 | 16.0 | +0.1 | 18.0 | +0.5 | 0.6 | ± 0.05 | 0.8 | ± 0.05 |
| 22.5 | ± 0.4 | 6.0 | +0.2 | 15.0 | +0.1 | 26.5 | +0.3 | 0.6 | ± 0.05 | 0.8 | ± 0.05 |
| 22.5 | ± 0.4 | 7.0 | +0.2 | 16.0 | +0.1 | 26.5 | +0.3 | 0.6 | ± 0.05 | 0.8 | ± 0.05 |
| 22.5 | ± 0.4 | 8.5 | +0.2 | 17.0 | +0.1 | 26.5 | +0.3 | 0.6 | ± 0.05 | 0.8 | ± 0.05 |
| 22.5 | ± 0.4 | 10.0 | +0.2 | 18.5 | +0.1 | 26.5 | +0.3 | 0.8 | ± 0.05 | 0.8 | ± 0.05 |
| 22.5 | ± 0.4 | 11.0 | +0.2 | 20.0 | +0.1 | 26.5 | +0.3 | 0.8 | ± 0.05 | 0.8 | ± 0.05 |
| 27.5 | ± 0.4 | 11.0 | +0.2 | 20.0 | +0.1 | 32.0 | +0.3 | 0.8 | ± 0.05 | 0.8 | ± 0.05 |
| 27.5 | ± 0.4 | 13.0 | +0.2 | 22.0 | +0.1 | 32.0 | +0.3 | 0.8 | ± 0.05 | 0.8 | ± 0.05 |
| 27.5 | ± 0.4 | 18.0 | +0.2 | 33.0 | +0.1 | 32.0 | +0.3 | 0.8 | ± 0.05 | 0.8 | ± 0.05 |

Note: See the Ordering Options Table for lead length (LL) options.



Performance Characteristics

| | | |
|--------------------------------|---|--|
| Rated Voltage | 160 VAC/250 VDC, 200 VAC/400 VDC, 220 VAC/630 VDC, 275 VAC, Class X2 | |
| Capacitance Range | 0.01 – 1.0 μ F | |
| Capacitance Tolerance | \pm 10%, \pm 20% | |
| Temperature Range | -55°C to +100°C, -40°C to +100°C (275 VAC) | |
| Climatic Category | 55/100/56, 40/100/56 (275 VAC) | |
| Approvals | ENEC, UL | |
| Dissipation Factor | Maximum Values at +23°C | |
| | Frequency | $\tan\delta$ |
| | 1 kHz | 0.1% |
| Test Voltage Between Terminals | The 100% screening factory test is carried out at 1.6 UR, 4.3 UR for 275 VAC. The voltage level is selected to meet the requirements in applicable equipment standards. All electrical characteristics are checked after the test. This test may not be repeated due to potential capacitor damage. KEMET is not liable for any failures that result from re-testing. | |
| Insulation Resistance | Between Terminals | |
| | $C \leq 0.33 \mu\text{F}$ | $\geq 10,000 \text{ M}\Omega$ |
| | $C > 0.33 \mu\text{F}$ | $\geq 3,000 \text{ M}\Omega \cdot \mu\text{F}$ |
| In DC Applications | Recommended voltage \leq 800 VDC | |

Environmental Test Data

| Test | IEC Publication | Procedure |
|------------------------|-------------------------|---|
| Vibration | IEC 60068-2-6 Test Fc | 3 directions at 2 hours each 10 – 500 Hz at 0.75 mm or 98 m/seconds ² |
| Bump | IEC 60068-2-29 Test Eb | 4,000 bumps at 390 m/seconds ² |
| Solderability | IEC 60068-2-20 Test Ta | Wetting time d or $d > 0.8 < 1.5$ seconds |
| Active Flammability | IEC 60384-14 | V_R +20 surge pulses at 2.5 kV (pulse every 5 seconds) |
| Passive Flammability | IEC 60384-14 | IEC 60384-1, IEC 60695-11-5 needle flame test |
| Damp Heat Steady State | IEC 60068-2-78 Test Cab | +40°C and 93% R.H., 56 days |

Approvals

| Certification Body | Specification | File Number |
|---|--------------------------------------|-------------|
|  | EN/IEC 60384-14 | CA08.00032 |
|  | UL 60384-14 and CAN/CSA-E60384-14 | E97797 |

Environmental Compliance

All KEMET EMI capacitors are RoHS compliant.



Circuit Drawings

Mounting: RC units are mounted parallel to the contacts to be protected or parallel to the inductive load (Figures 1 and 2). RC units are generally mounted parallel to the contacts to suppress radio interference (Figure 1).

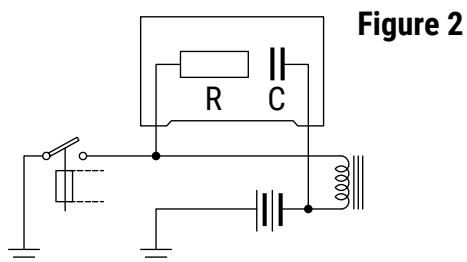
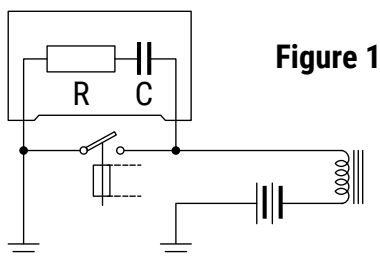

Table 1 – Ratings & Part Number Reference

| VAC | VDC | Capacitance Value (µF) | Max Dimensions in mm | | | Lead Spacing (S) | KEMET Part Number | Legacy Part Number |
|----------|-----|------------------------|----------------------|--------|--------|------------------|---------------------|----------------------|
| | | | T | H | L | | | |
| 160 | 250 | 0.25 | 8.5 | 14.5 | 18.0 | 15.0 | 43II3250(1)01(2)(3) | F43II3250(1)01(2)(3) |
| 160 | 250 | 0.33 | 6.0 | 15.0 | 26.5 | 22.5 | 43IN3330(1)01(2)(3) | F43IN3330(1)01(2)(3) |
| 160 | 250 | 0.47 | 8.5 | 17.0 | 26.5 | 22.5 | 43IN3470(1)01(2)(3) | F43IN3470(1)01(2)(3) |
| 160 | 250 | 0.5 | 8.5 | 17.0 | 26.5 | 22.5 | 43IN3500(1)01(2)(3) | F43IN3500(1)01(2)(3) |
| 160 | 250 | 1 | 10.0 | 18.5 | 26.5 | 22.5 | 43IN4100(1)01(2)(3) | F43IN4100(1)01(2)(3) |
| 200 | 400 | 0.25 | 7.0 | 16.0 | 26.5 | 22.5 | 43MN3250(1)01(2)(3) | F43MN3250(1)01(2)(3) |
| 200 | 400 | 0.5 | 10.0 | 18.5 | 26.5 | 22.5 | 43MN3500(1)01(2)(3) | F43MN3500(1)01(2)(3) |
| 200 | 400 | 1 | 13.0 | 22.0 | 32.0 | 27.5 | 43MR4100(1)01(2)(3) | F43MR4100(1)01(2)(3) |
| 220 | 630 | 0.022 | 7.5 | 14.5 | 18.0 | 15.0 | 43PI2220(1)01(2)(3) | F43PI2220(1)01(2)(3) |
| 220 | 630 | 0.1 | 7.0 | 16.0 | 26.5 | 22.5 | 43PN3100(1)01(2)(3) | F43PN3100(1)01(2)(3) |
| 220 | 630 | 0.25 | 11.0 | 20.0 | 26.5 | 22.5 | 43PN3250(1)01(2)(3) | F43PN3250(1)01(2)(3) |
| 220 | 630 | 0.5 | 13.0 | 22.0 | 32.0 | 27.5 | 43PR3500(1)01(2)(3) | F43PR3500(1)01(2)(3) |
| 275 (X2) | | 0.01 | 7.5 | 14.5 | 18.0 | 15.0 | 43KI2100(1)01(2)(3) | F43KI2100(1)01(2)(3) |
| 275 (X2) | | 0.015 | 7.5 | 14.5 | 18.0 | 15.0 | 43KI2150(1)01(2)(3) | F43KI2150(1)01(2)(3) |
| 275 (X2) | | 0.022 | 7.5 | 14.5 | 18.0 | 15.0 | 43KI2220(1)01(2)(3) | F43KI2220(1)01(2)(3) |
| 275 (X2) | | 0.033 | 7.5 | 14.5 | 18.0 | 15.0 | 43KI2330(1)01(2)(3) | F43KI2330(1)01(2)(3) |
| 275 (X2) | | 0.047 | 7.5 | 14.5 | 18.0 | 15.0 | 43KI2470(1)01(2)(3) | F43KI2470(1)01(2)(3) |
| 275 (X2) | | 0.068 | 10.0 | 16.0 | 18.0 | 15.0 | 43KI2680(1)01(2)(3) | F43KI2680(1)01(2)(3) |
| 275 (X2) | | 0.1 | 8.5 | 17.0 | 26.5 | 22.5 | 43KN3100(1)01(2)(3) | F43KN3100(1)01(2)(3) |
| 275 (X2) | | 0.15 | 10.0 | 18.5 | 26.5 | 22.5 | 43KN3150(1)01(2)(3) | F43KN3150(1)01(2)(3) |
| 275 (X2) | | 0.22 | 11.0 | 20.0 | 26.5 | 22.5 | 43KN3220(1)01(2)(3) | F43KN3220(1)01(2)(3) |
| 275 (X2) | | 0.25 | 11.0 | 20.0 | 32.0 | 27.5 | 43KR3250(1)01(2)(3) | F43KR3250(1)01(2)(3) |
| 275 (X2) | | 0.33 | 11.0 | 20.0 | 32.0 | 27.5 | 43KR3330(1)01(2)(3) | F43KR3330(1)01(2)(3) |
| 275 (X2) | | 0.47 | 13.0 | 22.0 | 32.0 | 27.5 | 43KR3470(1)01(2)(3) | F43KR3470(1)01(2)(3) |
| 275 (X2) | | 0.5 | 13.0 | 22.0 | 32.0 | 27.5 | 43KR3500(1)01(2)(3) | F43KR3500(1)01(2)(3) |
| 275 (X2) | | 0.68 | 18.0 | 33.0 | 32.0 | 27.5 | 43KR3680(1)01(2)(3) | F43KR3680(1)01(2)(3) |
| 275 (X2) | | 1 | 18.0 | 33.0 | 32.0 | 27.5 | 43KR4100(1)01(2)(3) | F43KR4100(1)01(2)(3) |
| VAC | VDC | Capacitance Value (µF) | T (mm) | H (mm) | L (mm) | Lead Spacing (S) | KEMET Part Number | Legacy Part Number |

(1) Lead and packaging code. Contact KEMET for availability and details.

(2) M = ±20%, K = ±10%.

(3) Resistance value [Ω] - R plus first two digits represent significant figures. Third digit specifies number of zeros:

R220 = 22 Ω

R470 = 47 Ω

R101 = 100 Ω

R221 = 220 Ω

R471 = 470 Ω

Soldering Process

The implementation of the RoHS directive has resulted in the selection of SnAuCu (SAC) alloys or SnCu alloys as primary solder. This has increased the liquidus temperature from that of 183°C for SnPb eutectic alloy to 217 – 221°C for the new alloys. As a result, the heat stress to the components, even in wave soldering, has increased considerably due to higher pre-heat and wave temperatures. Polypropylene capacitors are especially sensitive to heat (the melting point of polypropylene is 160 – 170°C). Wave soldering can be destructive, especially for mechanically small polypropylene capacitors (with lead spacing of 5 – 15 mm), and great care must be taken during soldering. The recommended solder profiles from KEMET should be used. Consult KEMET with any questions. In general, the wave soldering curve from IEC Publication 61760-1 Edition 2 serves as a solid guideline for successful soldering. See Figure 1.

Reflow soldering is not recommended for through-hole film capacitors. Exposing capacitors to a soldering profile in excess of the recommended limits may result in degradation of or permanent damage to the capacitors.

Do not place the polypropylene capacitor through an adhesive curing oven to cure resin for surface-mount components. Insert through-hole parts after curing the surface-mount parts. Consult KEMET to discuss the actual temperature profile in the oven, if through-hole components must pass through the adhesive curing process. A maximum of two soldering cycles is recommended. Allow time for the capacitor surface temperature to return to a normal temperature before the second soldering cycle.

Manual Soldering Recommendations

Following is the recommendation for manual soldering with a soldering iron.



Soldering iron tip temperature should be set at 350°C (+10°C maximum), with the soldering duration not to exceed more than 3 seconds.

Wave Soldering Recommendations

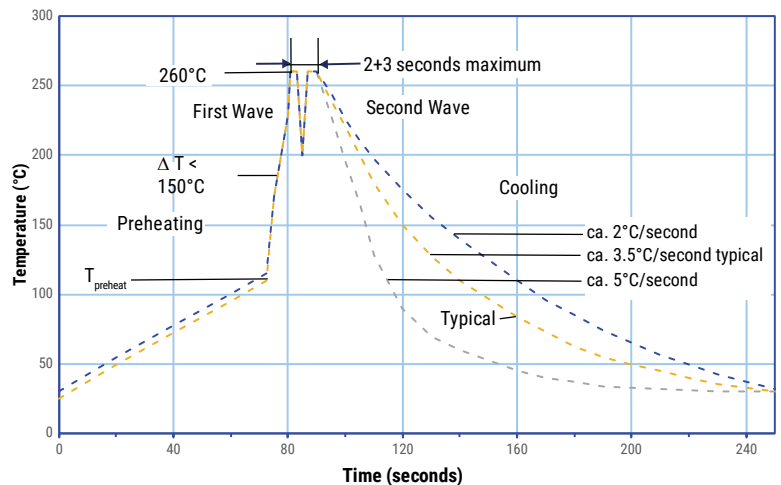

Soldering Process cont.

Wave Soldering Recommendations cont.

1. The table indicates the maximum setup temperature for the soldering process.

| Dielectric Film Material | Maximum Preheat Temperature | | Maximum Peak Soldering Temperature | |
|--------------------------|------------------------------|-------------------------|------------------------------------|-------------------------|
| | Capacitor Pitch \geq 10 mm | Capacitor Pitch > 15 mm | Capacitor Pitch \leq 15 mm | Capacitor Pitch > 15 mm |
| Polyester | 130°C | 130°C | 270°C | 270°C |
| Polypropylene | 110°C | 130°C | 260°C | 270°C |
| Paper | 130°C | 140°C | 270°C | 270°C |
| Polyphenylene Sulphide | 150°C | 160°C | 270°C | 270°C |

2. The maximum temperature measured inside the capacitor: set the temperature so that inside the element the maximum temperature is below the limit.

| Dielectric Film Material | Maximum Temperature Measured Inside the Element |
|--------------------------|---|
| Polyester | 160°C |
| Polypropylene | 110°C |
| Paper | 160°C |
| Polyphenylene Sulphide | 160°C |

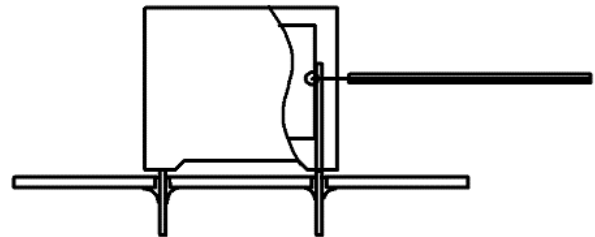

Temperature monitored inside the capacitor.

Selective Soldering Recommendations

Selective dip soldering is a variation of reflow soldering. In this method, the printed circuit board with through-hole components to be soldered is preheated and transported over the solder bath, as in normal flow soldering, without touching the solder. When the board is over the bath, it is stopped. Pre-designed solder pots are lifted from the bath with molten solder, only at the places of the selected components, and pressed against the lower surface of the board to solder the components.

The temperature profile for selective soldering is similar to the double wave flow soldering outlined in this document. **However, instead of two baths, there is only one with a time from 3 to 10 seconds.** In selective soldering, the risk of overheating is greater than in double wave flow soldering. Great care must be taken so that the parts do not overheat.

Marking

- KEMET’s logo
- Series
- Capacitance
- Rated resistance
- Rated voltage
- Capacitor class
- Approval marks
- IEC climatic category
- Passive flammability class
- Manufacturing date code

Packaging Quantities

| Lead Spacing | Thickness (mm) | Height (mm) | Length (mm) | Bulk Short Leads | Bulk Long Leads | | |
|------------------------|----------------|-------------|-------------|------------------|-----------------|-----|-----|
| Packaging Codes | | | | 00 | 40 – 50 | 51 | 52 |
| 15 | 6.0 | 17.5 | 18.0 | 1,000 | 700 | 700 | 250 |
| | 7.5 | 14.5 | 18.0 | 1,000 | 700 | 500 | 250 |
| | 8.5 | 14.5 | 18.0 | 1,000 | 500 | 500 | 250 |
| | 10.0 | 16.0 | 18.0 | 750 | 500 | 500 | 250 |
| 22.5 | 6.0 | 15.0 | 26.5 | 805 | 500 | 500 | 250 |
| | 7.5 | 16.0 | 26.5 | 700 | 500 | 400 | 250 |
| | 8.5 | 17.0 | 26.5 | 468 | 300 | 300 | 200 |
| | 10.0 | 18.5 | 26.5 | 396 | 300 | 250 | 200 |
| | 11.0 | 20.0 | 26.5 | 360 | 250 | 200 | 200 |
| 27.5 | 11.0 | 20.0 | 32.0 | 600 | 336 | 336 | 150 |
| | 13.0 | 22.0 | 32.0 | 480 | 288 | 288 | 150 |
| | 18.0 | 33.0 | 32.0 | 256 | 128 | 128 | 150 |

Lead Taping & Packaging (IEC 60286-2)

Figure 1
 Lead Spacing 15 mm

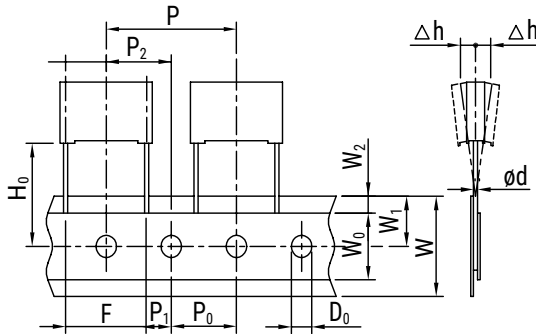
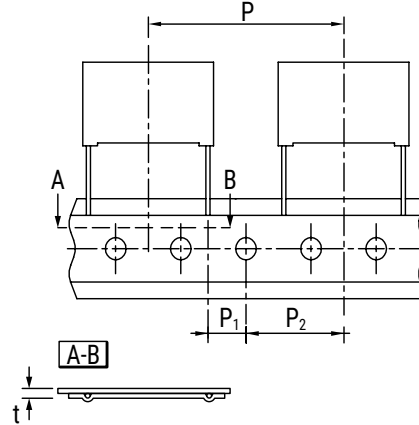

Figure 2
 Lead Spacing 22.5 and 27.5 mm



Taping Specification

| Description | Symbol | Dimensions (mm) | | | | Tolerance |
|--------------------------------------|---------------------|-----------------|------------------|------------------|-----------|-----------|
| | | Lead Space | | | | |
| | | 15 Figure 1 | 22.5 Figure 2 | 27.5 Figure 2 | | |
| Lead Wire Diameter | d | 0.6 – 0.8 | 0.8 | 0.8 | ±0.05 | |
| Taping Lead Space | P | 25.4 | 38.1 | 38.1 | ±1 | |
| Feed-hole Lead Space* | P ₀ | 12.7 | 12.7 | 12.7 | ±0.2** | |
| Centering of the Lead Wire | P ₁ | 5.2 | 7.8 | 5.3 | ±0.7 | |
| Centering of the Body | P ₂ | 12.7 | 19.05 | 19.05 | ±1.3 | |
| Lead Spacing (Pitch)*** | F | 15 | 22.5 | 27.5 | +0.6/-0.1 | |
| Component Alignment | Δh | 0 | 0 | 0 | ±2 | |
| Height of Component from Tape Center | H ₀ **** | 18.5 | 18.5 | 18.5 | ±0.5 | |
| Carrier Tape Width | W | 18.0 | 18.0 | 18.0 | +1/-0.5 | |
| Hold Down Tape Width | W ₀ | 10.0 | 10.0 | 10.0 | Minimum | |
| Hole Position | W ₁ | 10.0 | 10.0 | 10.0 | ±0.5 | |
| Hold Down Tape Position | W ₂ | 3.0 | 3.0 | 3.0 | Maximum | |
| Feed-hole Diameter | D ₀ | 4.0 | 4.0 | 4.0 | ±0.2 | |
| Total Tape Thickness | t | 0.7 | 0.7 | 0.7 | ±0.2 | |

* Available also in 15 mm

** Maximum 1 mm on 20 lead spaces

*** Pitches 15 mm and 10 mm taped to 7.5 mm (crimped leads) available upon request

**** H₀ = 16.5 mm available upon request

Lead Taping & Packaging (IEC 60286–2) cont.

Ammo Specifications

| Dimensions (mm) | | |
|-----------------|-----|----|
| H | W | T |
| 360 | 340 | 59 |



Reel Specifications

| Dimensions (mm) | | |
|-----------------|----|------------|
| D | H | W |
| 355 | 30 | 55 Maximum |
| 500 | 25 | |

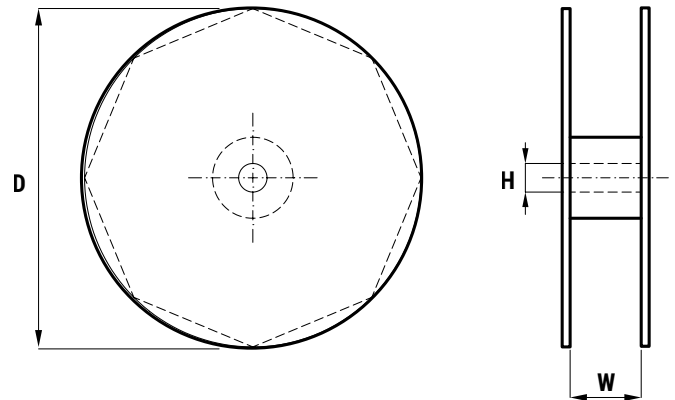

Manufacturing Date Code (IEC–60062)

| Y = Year, Z = Month | | | |
|---------------------|------|-----------|------|
| Year | Code | Month | Code |
| 2010 | A | January | 1 |
| 2011 | B | February | 2 |
| 2012 | C | March | 3 |
| 2013 | D | April | 4 |
| 2014 | E | May | 5 |
| 2015 | F | June | 6 |
| 2016 | H | July | 7 |
| 2017 | J | August | 8 |
| 2018 | K | September | 9 |
| 2019 | L | October | 0 |
| 2020 | M | November | N |
| 2021 | N | December | D |
| 2022 | P | | |
| 2023 | R | | |
| 2024 | S | | |
| 2025 | T | | |
| 2026 | U | | |
| 2027 | V | | |
| 2028 | W | | |
| 2029 | X | | |
| 2030 | A | | |

KEMET Electronics Corporation Sales Offices

For a complete list of our global sales offices, please visit www.kemet.com/sales.

Disclaimer

All product specifications, statements, information and data (collectively, the "Information") in this datasheet are subject to change. The customer is responsible for checking and verifying the extent to which the Information contained in this publication is applicable to an order at the time the order is placed. All Information given herein is believed to be accurate and reliable, but it is presented without guarantee, warranty, or responsibility of any kind, expressed or implied.

Statements of suitability for certain applications are based on KEMET Electronics Corporation's ("KEMET") knowledge of typical operating conditions for such applications, but are not intended to constitute – and KEMET specifically disclaims – any warranty concerning suitability for a specific customer application or use. The Information is intended for use only by customers who have the requisite experience and capability to determine the correct products for their application. Any technical advice inferred from this Information or otherwise provided by KEMET with reference to the use of KEMET's products is given gratis, and KEMET assumes no obligation or liability for the advice given or results obtained.

Although KEMET designs and manufactures its products to the most stringent quality and safety standards, given the current state of the art, isolated component failures may still occur. Accordingly, customer applications which require a high degree of reliability or safety should employ suitable designs or other safeguards (such as installation of protective circuitry or redundancies) in order to ensure that the failure of an electrical component does not result in a risk of personal injury or property damage.

Although all product-related warnings, cautions and notes must be observed, the customer should not assume that all safety measures are indicated or that other measures may not be required.

KEMET is a registered trademark of KEMET Electronics Corporation.

单击下面可查看定价，库存，交付和生命周期等信息

[>>KEMET\(基美\)](#)