

Overview

The KEMET T489 provides DC leakage current that is 25% lower than the commercial T491. The T489 also offers improved reliability, low ESR options, and meets or exceeds the requirements of EIA standard 535BAAC. This series is classified as moisture sensitivity level (MSL) 1 under J STD 020, with unlimited floor life time at $\leq 30^{\circ}\text{C}/85\%$ RH. The T489 standard terminations are available in 100% matte tin and provide excellent wetting characteristics and

compatibility with today's surface mount solder systems. Tin/lead (Sn/Pb) terminations are available upon request for any part number. Gold-plated terminations are also available for use with conductive epoxy attachment processes. Standard packaging of these devices is Tape & Reel in accordance with EIA 481. This system provides perfect compatibility with all tape-fed placement units.

Benefits

- Complies with AEC-Q200
- DC Leakage at 0.0075CV
- Improved reliability: 0.50%/1,000 hours, 85°C, rated voltage
- Low ESR options available
- Meets or exceeds EIA standard 535BAAC
- Tape & Reel standard packaging per EIA 481
- Symmetrical, compliant terminations
- Laser-marked case

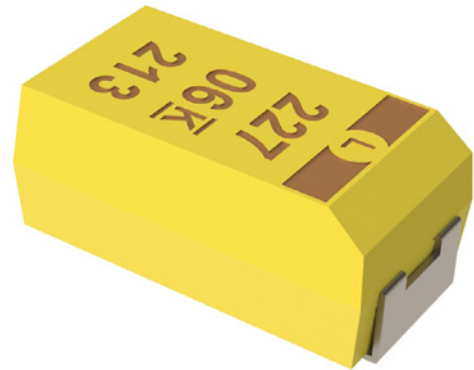

Applications

Typical applications include decoupling and filtering in automotive high-end applications.

Environmental Compliance

RoHS compliant (6/6) according to Directive 2002/95/EC when ordered with 100% Sn solder or gold-plated.

- Halogen-free
- Epoxy compliant with UL94 V-0
- Molded Epoxy complies for outgassing testing under ASTM E 595.

K-SIM

For a detailed analysis of specific part numbers, please visit ksim.kemet.com to access KEMET's K-SIM software. KEMET K-SIM is designed to simulate behavior of components with respect to frequency, ambient temperature, and DC bias levels.

Ordering Information

T	489	B	156	M	016	A	T	A800	
Capacitor Class	Series	Case Size	Capacitance Code (pF)	Capacitance Tolerance	Rated Voltage (VDC)	Failure Rate/Design	Termination Finish	C-Spec	Packaging (C-Spec)
T = Tantalum	Low DC leakage series	A B C D X	First two digits represent significant figures. Third digit specifies number of zeros.	K = ±10% M = ±20%	006 = 6.3 010 = 10 016 = 16 020 = 20 025 = 25 035 = 35 050 = 50	A = N/A	T = 100% Matte tin (Sn)-plated H = Standard solder coated (SnPb 5% Pb minimum) G = Gold-plated	A = Automotive grade 800 = ESR value (800 = 800 mΩ)	Blank = 7" reel 7280 = 13" reel

Performance Characteristics

Item	Performance Characteristics
Operating Temperature	-55°C to 125°C
Rated Capacitance Range	0.10 – 470 µF at 120 Hz/25°C
Capacitance Tolerance	K Tolerance (±10%), M Tolerance (±20%)
Rated Voltage Range	6.3 – 50 V
DF (120 Hz)	Refer to Part Number Electrical Specification
ESR (100 kHz)	Refer to Part Number Electrical Specification
Leakage Current	≤ 0.0075 CV (µA) at rated voltage after 5 minutes
Reliability	0.50%/1,000 hours at 85°C, V _R with 0.1 Ω series resistance

Qualification

Test	Condition	Characteristics				
Endurance	85°C at rated voltage, 2,000 hours 125°C at 2/3 rated voltage, 2,000 hours	Δ C/C	Within ±10% of initial value			
		DF	Within initial limits			
		DCL	Within 1.25 x initial limit			
		ESR	Within initial limits			
Storage Life	125°C at 0 volts, 2,000 hours	Δ C/C	Within ±10% of initial value			
		DF	Within initial limits			
		DCL	Within 1.25 x initial limit			
		ESR	Within initial limits			
Thermal Shock	MIL-STD-202, Method 107, Condition B, mounted, -55°C to 125°C, 1,000 cycles	Δ C/C	Within ±5% of initial value			
		DF	Within initial limits			
		DCL	Within 1.25 x initial limit			
		ESR	Within initial limits			
Temperature Stability	Extreme temperature exposure at a succession of continuous steps at +25°C, -55°C, +25°C, +85°C, +125°C, +25°C		+25°C	-55°C	+85°C	+125°C
		Δ C/C	IL*	±10%	±10%	±20%
		DF	IL	IL	1.5 x IL	1.5 x IL
		DCL	IL	N/A	10 x IL	12 x IL
Surge Voltage	85°C, 1.32 x rated voltage 1,000 cycles (125°C, 1.2 x rated voltage)	Δ C/C	Within ±5% of initial value			
		DF	Within initial limits			
		DCL	Within initial limits			
		ESR	Within initial limits			
Mechanical Shock/ Vibration	MIL-STD-202, Method 213, Condition I, 100 G peak. MIL-STD-202, Method 204, Condition D, 10 Hz to 2,000 Hz, 20 G peak	Δ C/C	Within ±10% of initial value			
		DF	Within initial limits			
		DCL	Within initial limits			

*IL = Initial limit

Certification

KEMET's Internal Qualification Plan for this Tantalum series of capacitors follows AEC-Q200 guidelines. Standard catalog part types ordered without a specific automotive designator, i.e., suffix AUTO or four digit customer specific designator (C-Spec), are not considered KEMET automotive grade tantalum capacitors.

Dimensions – Millimeters (Inches)

Metric will govern

CATHODE (-) END VIEW

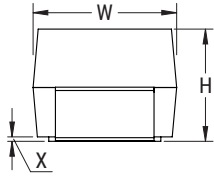

SIDE VIEW

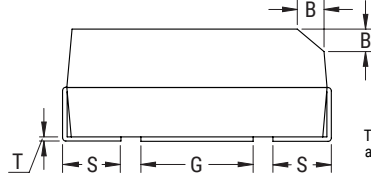

ANODE (+) END VIEW

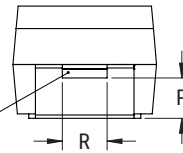

Termination cutout at KEMET's option, either end

BOTTOM VIEW

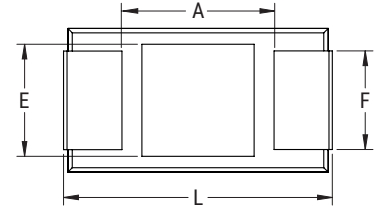

Case Size		Component												
KEMET	EIA	L	W	H	F ±0.1 ±(0.004)	S ±0.3 ±(0.012)	B ±0.15 (Ref) ±0.006	X (Ref)	P (Ref)	R (Ref)	T (Ref)	A (Min)	G (Ref)	E (Ref)
A	3216-18	3.2±0.2 (0.126±0.008)	1.6±0.2 (0.063±0.008)	1.6±0.2 (0.063±0.008)	1.2 (0.047)	0.8 (0.031)	0.4 (0.016)	0.10±0.10 (0.004±0.004)	0.4 (0.016)	0.4 (0.016)	0.13 (0.005)	1.2 (0.047)	1.1 (0.043)	1.3 (0.051)
B	3528-21	3.5±0.2 (0.138±0.008)	2.8±0.2 (0.110±0.008)	1.9±0.2 (0.075±0.008)	2.2 (0.087)	0.8 (0.031)	0.4 (0.016)	0.10±0.10 (0.004±0.004)	0.5 (0.020)	1.0 (0.039)	0.13 (0.005)	1.9 (0.075)	1.8 (0.071)	2.2 (0.087)
C	6032-28	6.0±0.3 (0.236±0.012)	3.2±0.3 (0.126±0.012)	2.5±0.3 (0.098±0.012)	2.2 (0.087)	1.3 (0.051)	0.5 (0.020)	0.10±0.10 (0.004±0.004)	0.9 (0.035)	1.0 (0.039)	0.13 (0.005)	3.1 (0.122)	2.8 (0.110)	2.4 (0.094)
D	7343-31	7.3±0.3 (0.287±0.012)	4.3±0.3 (0.169±0.012)	2.8±0.3 (0.110±0.012)	2.4 (0.094)	1.3 (0.051)	0.5 (0.020)	0.10±0.10 (0.004±0.004)	0.9 (0.035)	1.0 (0.039)	0.13 (0.005)	3.8 (0.150)	3.5 (0.138)	3.5 (0.138)
X	7343-43	7.3±0.3 (0.287±0.012)	4.3±0.3 (0.169±0.012)	4.0±0.3 (0.157±0.012)	2.4 (0.094)	1.3 (0.051)	0.5 (0.020)	0.10±0.10 (0.004±0.004)	1.7 (0.067)	1.0 (0.039)	0.13 (0.005)	3.8 (0.150)	3.5 (0.138)	3.5 (0.138)

Notes: (Ref) – Dimensions provided for reference only.

Table 1 – Ratings & Part Number Reference

Rated Voltage	Rated Cap	Case Code/ Case Size	KEMET Part Number	DC Leakage	DF	Standard ESR		Low ESR		Maximum Operating Temp
VDC at 85°C	µF	KEMET/EIA	(See below for part options)	µA at +25°C Max/5 Minutes	% at +25°C 120 Hz Maximum	mΩ at +25°C 100 kHz Max	E-Spec Code	mΩ at +25°C 100 kHz Max	E-Spec Code	°C
6.3	10	B/3528-21	T489B106(1)006A(2)(3)	0.5	6.0	3000	A3K0			125
6.3	15	A/3216-18	T489A156(1)006A(2)(3)	0.7	6.0	2000	A2K0			125
6.3	22	B/3528-21	T489B226(1)006A(2)(3)	1.0	6.0	2000	A2K0	1500	A1K5	125
6.3	47	B/3528-21	T489B476(1)006A(2)(3)	2.2	6.0	1620	A1K6	500	A500	125
6.3	100	C/6032-29	T489C107(1)006A(2)(3)	4.7	6.0	440	A440			125
6.3	150	D/7343-31	T489D157(1)006A(2)(3)	7.1	6.0	400	A400	150	A150	125
6.3	220	D/7343-31	T489D227(1)006A(2)(3)	10.4	8.0	360	A360	150	A150	125
6.3	470	X/7343-43	T489X477(1)006A(2)(3)	22.2	8.0	250	A250	200	A200	125
10	2.2	A/3216-18	T489A225(1)010A(2)(3)	0.5	6.0	7000	A7K0			125
10	4.7	A/3216-18	T489A475(1)010A(2)(3)	0.5	6.0	2900	A2K9			125
10	6.8	A/3216-18	T489A685(1)010A(2)(3)	0.5	6.0	2650	A2K6			125
10	6.8	B/3528-21	T489B685(1)010A(2)(3)	0.5	6.0	3000	A3K0			125
10	10	A/3216-18	T489A106(1)010A(2)(3)	0.8	6.0	2200	A2K2	1800	A1K8	125
10	15	B/3528-21	T489B156(1)010A(2)(3)	1.1	6.0	2030	A2K0			125
10	22	B/3528-21	T489B226(1)010A(2)(3)	1.7	6.0	1880	A1K8	700	A700	125
10	33	B/3528-21	T489B336(1)010A(2)(3)	2.5	6.0	1000	A1K0	650	A650	125
10	33	C/6032-28	T489C336(1)010A(2)(3)	2.5	6.0	590	A590			125
10	47	C/6032-28	T489C476(1)010A(2)(3)	3.5	6.0	540	A540			125
10	47	D/7343-31	T489D476(1)010A(2)(3)	3.5	6.0	400	A400			125
10	68	C/6032-28	T489C686(1)010A(2)(3)	5.1	6.0	490	A490			125
10	100	C/6032-28	T489C107(1)010A(2)(3)	7.5	8.0	500	A500	200	A200	125
10	100	D/7343-31	T489D107(1)010A(2)(3)	7.5	6.0	440	A440	150	A150	125
10	150	D/7343-31	T489D157(1)010A(2)(3)	11.3	8.0	400	A400	150	A150	125
10	220	D/7343-31	T489D227(1)010A(2)(3)	16.5	8.0	500	A500			125
10	330	X/7343-43	T489X337(1)010A(2)(3)	24.8	8.0	300	A300			125
16	1	A/3216-18	T489A105(1)016A(2)(3)	0.5	6.0	10000	A10K			125
16	2.2	A/3216-18	T489A225(1)016A(2)(3)	0.5	6.0	4550	A4K5	3500	A3K5	125
16	3.3	B/3528-21	T489B335(1)016A(2)(3)	0.5	6.0	4500	A4K5			125
16	4.7	B/3528-21	T489B475(1)016A(2)(3)	0.6	6.0	3160	A3K1			125
16	6.8	B/3528-21	T489B685(1)016A(2)(3)	0.8	6.0	2650	A2K6			125
16	10	B/3528-21	T489B106(1)016A(2)(3)	1.2	6.0	2200	A2K2			125
16	10	C/6032-28	T489C106(1)016A(2)(3)	1.2	6.0	2000	A2K0			125
16	15	B/3528-21	T489B156(1)016A(2)(3)	1.8	6.0	2030	A2K0	800	A800	125
16	22	B/3528-21	T489B226(1)016A(2)(3)	2.6	6.0	1100	A1K1	600	A600	125
16	22	C/6032-28	T489C226(1)016A(2)(3)	2.6	6.0	700	A700	350	A350	125
16	33	C/6032-28	T489C336(1)016A(2)(3)	4.0	6.0	590	A590			125
16	47	C/6032-28	T489C476(1)016A(2)(3)	5.6	6.0	540	A540	350	A350	125
16	47	D/7343-31	T489D476(1)016A(2)(3)	5.6	6.0	540	A540	200	A200	125
16	68	D/7343-31	T489D686(1)016A(2)(3)	8.2	6.0	490	A490	150	A150	125
16	100	D/7343-31	T489D107(1)016A(2)(3)	12.0	6.0	440	A440	150	A150	125
16	150	X/7343-44	T489X157(1)016A(2)(3)	18.0	12.0	700	A700	150	A150	125
20	1	A/3216-18	T489A105(1)020A(2)(3)	0.5	4.0	6630	A6K6			125
20	1.5	A/3216-18	T489A155(1)020A(2)(3)	0.5	6.0	5460	A5K4			125
20	2.2	A/3216-18	T489A225(1)020A(2)(3)	0.5	6.0	4550	A4K5			125
20	3.3	A/3216-18	T489A335(1)020A(2)(3)	0.5	6.0	3740	A3K7	3500	A3K5	125
20	3.3	B/3528-21	T489B335(1)020A(2)(3)	0.5	6.0	3740	A3K7			125
20	4.7	B/3528-21	T489B475(1)020A(2)(3)	0.7	6.0	3160	A3K1			125
VDC at 85°C	µF	KEMET/EIA	(See below for part options)	µA at +25°C Max/5 Minutes	% at +25°C 120 Hz Maximum	mΩ at +25°C 100 kHz Max	E-Spec Code	mΩ at +25°C 100 kHz Max	E-Spec Code	°C
Rated Voltage	Rated Cap	Case Code/ Case Size	KEMET Part Number	DC Leakage	DF	Standard ESR		Low ESR		Maximum Operating Temp

(1) To complete KEMET part number, insert M for ±20% or K for ±10%. Designates Capacitance tolerance.

(2) To complete KEMET part number, insert T = 100% Matte Tin (Sn)-Plated, G = Gold-Plated, H = Standard Solder coated (SnPb 5% Pb minimum). Designates Termination Finish.

(3) To complete KEMET part number, insert the ESR specification code.

Refer to Ordering Information for additional detail.

Higher voltage ratings and tighter tolerance product including ESR may be substituted within the same size at KEMET's option. Voltage substitution will be marked with the higher voltage rating. Substitutions can include better than series.

Table 1 – Ratings & Part Number Reference cont.

Rated Voltage	Rated Cap	Case Code/ Case Size	KEMET Part Number	DC Leakage	DF	Standard ESR		Low ESR		Maximum Operating Temp
						mΩ at +25°C 100 kHz Max	E-Spec Code	mΩ at +25°C 100 kHz Max	E-Spec Code	
VDC at 85°C	μF	KEMET/EIA	(See below for part options)	μA at +25°C Max/5 Minutes	% at +25°C 120 Hz Maximum	mΩ at +25°C 100 kHz Max	E-Spec Code	mΩ at +25°C 100 kHz Max	E-Spec Code	°C
20	6.8	B/3528-21	T489B685(1)020A(2)(3)	1.0	6.0	2650	A2K6			125
20	6.8	C/6032-28	T489C685(1)020A(2)(3)	1.0	6.0	2000	A2K0			125
20	10	B/3528-21	T489B106(1)020A(2)(3)	1.5	6.0	2200	A2K2	1000	A1K0	125
20	10	C/6032-28	T489C106(1)020A(2)(3)	1.5	6.0	800	A800	500	A500	125
20	15	C/6032-28	T489C156(1)020A(2)(3)	2.3	6.0	720	A720	400	A400	125
20	22	D/7343-31	T489D226(1)020A(2)(3)	3.3	6.0	650	A650	300	A300	125
20	33	C/6032-28	T489C336(1)020A(2)(3)	5.0	6.0	590	A590	300	A300	125
20	33	D/7343-31	T489D336(1)020A(2)(3)	5.0	6.0	590	A590	250	A250	125
20	47	D/7343-31	T489D476(1)020A(2)(3)	7.1	6.0	540	A540	200	A200	125
20	68	D/7343-31	T489D686(1)020A(2)(3)	10.2	6.0	490	A490	200	A200	125
20	100	X/7343-43	T489X107(1)020A(2)(3)	15.0	6.0	300	A300	150	A150	125
25	0.47	A/3216-18	T489A474(1)025A(2)(3)	0.5	4.0	9530	A9K5	7000	A7K0	125
25	0.68	A/3216-18	T489A684(1)025A(2)(3)	0.5	4.0	7980	A7K9			125
25	1	A/3216-18	T489A105(1)025A(2)(3)	0.5	4.0	6630	A6K6			125
25	2.2	B/3528-21	T489B225(1)025A(2)(3)	0.5	6.0	4550	A4K5			125
25	3.3	B/3528-21	T489B335(1)025A(2)(3)	0.6	6.0	3740	A3K7	2000	A2K0	125
25	4.7	B/3528-21	T489B475(1)025A(2)(3)	0.9	6.0	3160	A3K1	1000	A1K0	125
25	6.8	B/3528-21	T489B685(1)025A(2)(3)	1.3	6.0	1500	A1K5	1000	A1K0	125
25	6.8	C/6032-28	T489C685(1)025A(2)(3)	1.3	6.0	1070	A1K0	600	A600	125
25	10	C/6032-28	T489C106(1)025A(2)(3)	1.9	6.0	800	A800	600	A600	125
25	10	D/7343-31	T489D106(1)025A(2)(3)	1.9	6.0	1200	A1K2			125
25	15	C/6032-28	T489C156(1)025A(2)(3)	2.8	6.0	720	A720			125
25	15	D/7343-31	T489D156(1)025A(2)(3)	2.8	6.0	720	A720	300	A300	125
25	22	D/7343-31	T489D226(1)025A(2)(3)	4.1	6.0	650	A650	300	A300	125
25	33	D/7343-31	T489D336(1)025A(2)(3)	6.2	6.0	590	A590	400	A400	125
25	47	D/7343-31	T489D476(1)025A(2)(3)	8.8	6.0	540	A540	250	A250	125
35	0.1	A/3216-18	T489A104(1)035A(2)(3)	0.5	4.0	20000	A20K			125
35	0.22	A/3216-18	T489A224(1)035A(2)(3)	0.5	4.0	13710	A13K			125
35	0.33	A/3216-18	T489A334(1)035A(2)(3)	0.5	4.0	11280	A11K			125
35	1	A/3216-18	T489A105(1)035A(2)(3)	0.5	4.0	6630	A6K6	3000	A3K0	125
35	1	B/3528-21	T489B105(1)035A(2)(3)	0.5	4.0	3400	A3K4	2000	A2K0	125
35	1.5	B/3528-21	T489B155(1)035A(2)(3)	0.5	6.0	5460	A5K4	2500	A2K5	125
35	2.2	B/3528-21	T489B225(1)035A(2)(3)	0.6	6.0	4550	A4K5	2000	A2K0	125
35	3.3	B/3528-21	T489B335(1)035A(2)(3)	0.9	6.0	3740	A3K7			125
35	3.3	C/6032-28	T489C335(1)035A(2)(3)	0.9	6.0	1840	A1K8	800	A800	125
35	4.7	C/6032-28	T489C475(1)035A(2)(3)	1.2	6.0	1410	A1K4	600	A600	125
35	6.8	C/6032-28	T489C685(1)035A(2)(3)	1.8	6.0	1070	A1K0	600	A600	125
35	6.8	D/7343-31	T489D685(1)035A(2)(3)	1.8	6.0	1300	A1K3			125
35	10	C/6032-28	T489C106(1)035A(2)(3)	2.6	6.0	800	A800	600	A600	125
35	10	D/7343-31	T489D106(1)035A(2)(3)	2.6	6.0	800	A800	400	A400	125
35	15	D/7343-31	T489D156(1)035A(2)(3)	3.9	6.0	720	A720	350	A350	125
35	22	D/7343-31	T489D226(1)035A(2)(3)	5.8	6.0	650	A650	300	A300	125
50	0.22	A/3216-18	T489A224(1)050A(2)(3)	0.5	4.0	7500	A7K5	7000	A7K0	125
50	0.33	A/3216-18	T489A334(1)050A(2)(3)	0.5	4.0	7000	A7K0			125
50	0.68	B/3528-21	T489B684(1)050A(2)(3)	0.5	4.0	4000	A4K0	2000	A2K0	125
50	1	C/6032-28	T489C105(1)050A(2)(3)	0.5	4.0	3000	A3K0			125
50	1.5	C/6032-28	T489C155(1)050A(2)(3)	0.6	6.0	2500	A2K5	1500	A1K5	125
VDC at 85°C	μF	KEMET/EIA	(See below for part options)	μA at +25°C Max/5 Minutes	% at +25°C 120 Hz Maximum	mΩ at +25°C 100 kHz Max	E-Spec Code	mΩ at +25°C 100 kHz Max	E-Spec Code	°C
Rated Voltage	Rated Cap	Case Code/ Case Size	KEMET Part Number	DC Leakage	DF	Standard ESR		Low ESR		Maximum Operating Temp

(1) To complete KEMET part number, insert M for ±20% or K for ±10%. Designates Capacitance tolerance.

(2) To complete KEMET part number, insert T = 100% Matte Tin (Sn) Plated, G = Gold Plated, H = Standard Solder coated (SnPb 5% Pb minimum). Designates Termination Finish.

(3) To complete KEMET part number, insert the ESR specification code.

Refer to Ordering Information for additional detail.

Higher voltage ratings and tighter tolerance product including ESR may be substituted within the same size at KEMET's option. Voltage substitution will be marked with the higher voltage rating. Substitutions can include better than series.

Table 1 – Ratings & Part Number Reference cont.

Rated Voltage	Rated Cap	Case Code/ Case Size	KEMET Part Number	DC Leakage	DF	Standard ESR		Low ESR		Maximum Operating Temp
						mΩ at +25°C 100 kHz Max	E-Spec Code	mΩ at +25°C 100 kHz Max	E-Spec Code	
VDC at 85°C	μF	KEMET/EIA	(See below for part options)	μA at +25°C Max/5 Minutes	% at +25°C 120 Hz Maximum	mΩ at +25°C 100 kHz Max	E-Spec Code	mΩ at +25°C 100 kHz Max	E-Spec Code	°C
50	2.2	C/6032-28	T489C225(1)050A(2)(3)	0.8	6.0	1700	A1K7	1000	A1K0	125
50	2.2	D/7343-31	T489D225(1)050A(2)(3)	0.8	4.5	2000	A2K0	1200	A1K2	125
50	3.3	D/7343-31	T489D335(1)050A(2)(3)	1.2	4.5	1100	A1K1	800	A800	125
50	4.7	D/7343-31	T489D475(1)050A(2)(3)	1.8	4.5	900	A900	600	A600	125
50	6.8	D/7343-31	T489D685(1)050A(2)(3)	2.6	4.5	700	A700			125
VDC at 85°C	μF	KEMET/EIA	(See below for part options)	μA at +25°C Max/5 Minutes	% at +25°C 120 Hz Maximum	mΩ at +25°C 100 kHz Max	E-Spec Code	mΩ at +25°C 100 kHz Max	E-Spec Code	°C
Rated Voltage	Rated Cap	Case Code/ Case Size	KEMET Part Number	DC Leakage	DF	Standard ESR		Low ESR		Maximum Operating Temp

(1) To complete KEMET part number, insert M for ±20% or K for ±10%. Designates Capacitance tolerance.

(2) To complete KEMET part number, insert T = 100% Matte Tin (Sn) Plated, G = Gold Plated, H = Standard Solder coated (SnPb 5% Pb minimum). Designates Termination Finish.

(3) To complete KEMET part number, insert the ESR specification code.

Refer to Ordering Information for additional detail.

Higher voltage ratings and tighter tolerance product including ESR may be substituted within the same size at KEMET's option. Voltage substitution will be marked with the higher voltage rating. Substitutions can include better than series.

Recommended Voltage Derating Guidelines

	-55°C to 85°C	85°C to 125°C
% Change in working DC voltage with temperature	V _R	67% of V _R
Recommended maximum application voltage	50% of V _R	33% of V _R

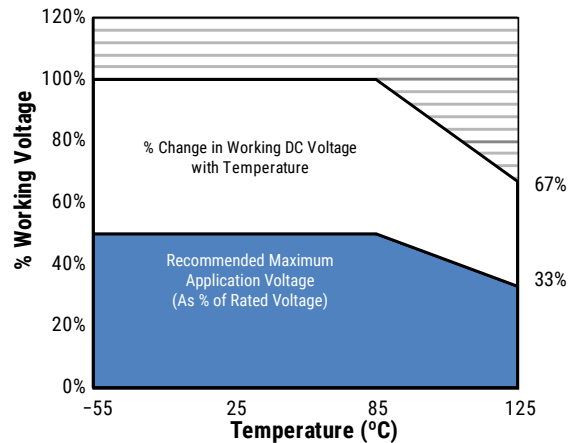

Ripple Current/Ripple Voltage

Permissible AC ripple voltage and current are related to equivalent series resistance (ESR) and the power dissipation capabilities of the device. Permissible AC ripple voltage which may be applied is limited by two criteria:

1. The positive peak AC voltage plus the DC bias voltage, if any, must not exceed the DC voltage rating of the capacitor.
2. The negative peak AC voltage in combination with bias voltage, if any, must not exceed the allowable limits specified for reverse voltage. See the Reverse Voltage section for allowable limits.

The maximum power dissipation by case size can be determined using the table at right. The maximum power dissipation rating stated in the table must be reduced with increasing environmental operating temperatures. Refer to the table below for temperature compensation requirements.

KEMET Series and Case Code	EIA Case Code	Maximum Power Dissipation (P max) mWatts at 25°C with +20°C Rise
A	3216-18	75
B	3528-21	85
C	6032-28	110
D	7343-31	150
X	7343-43	165
E	7360-38	200
S	3216-12	60
T	3528-12	70
U	6032-15	90
V	7343-20	125
T510X	7343-43	270
T510E	7360-38	285

Temperature Compensation Multipliers for Maximum Ripple Current		
T ≤ 25°C	T ≤ 85°C	T ≤ 125°C
1.00	0.90	0.40

T = Environmental Temperature

The maximum power dissipation rating must be reduced with increasing environmental operating temperatures. Refer to the Temperature Compensation Multiplier table for details.

Using the P max of the device, the maximum allowable rms ripple current or voltage may be determined.

$$I(max) = \sqrt{P_{max}/R}$$

$$E(max) = Z \sqrt{P_{max}/R}$$

- I = rms ripple current (amperes)
- E = rms ripple voltage (volts)
- P max = maximum power dissipation (watts)
- R = ESR at specified frequency (ohms)
- Z = Impedance at specified frequency (ohms)

Reverse Voltage

Solid tantalum capacitors are polar devices and may be permanently damaged or destroyed if connected with the wrong polarity. The positive terminal is identified on the capacitor body by a stripe plus in some cases a beveled edge. A small degree of transient reverse voltage is permissible for short periods per the table. The capacitors should not be operated continuously in reverse mode, even within these limits.

Temperature	Permissible Transient Reverse Voltage
25°C	15% of Rated Voltage
85°C	5% of Rated Voltage
125°C	1% of Rated Voltage

Table 2 – Land Dimensions/Courtyard

KEMET	Metric Size Code	Density Level A: Maximum (Most) Land Protrusion (mm)					Density Level B: Median (Nominal) Land Protrusion (mm)					Density Level C: Minimum (Least) Land Protrusion (mm)				
		Case	EIA	W	L	S	V1	V2	W	L	S	V1	V2	W	L	S
A	3216-18	1.35	2.20	0.62	6.02	2.80	1.23	1.80	0.82	4.92	2.30	1.13	1.42	0.98	4.06	2.04
B	3528-21	2.35	2.21	0.92	6.32	4.00	2.23	1.80	1.12	5.22	3.50	2.13	1.42	1.28	4.36	3.24
C	6032-28	2.35	2.77	2.37	8.92	4.50	2.23	2.37	2.57	7.82	4.00	2.13	1.99	2.73	6.96	3.74
D	7343-31	2.55	2.77	3.67	10.22	5.60	2.43	2.37	3.87	9.12	5.10	2.33	1.99	4.03	8.26	4.84
X ¹	7343-43	2.55	2.77	3.67	10.22	5.60	2.43	2.37	3.87	9.12	5.10	2.33	1.99	4.03	8.26	4.84

Density Level A: For low-density product applications. Recommended for wave solder applications and provides a wider process window for reflow solder processes.

Density Level B: For products with a moderate level of component density. Provides a robust solder attachment condition for reflow solder processes.

Density Level C: For high component density product applications. Before adapting the minimum land pattern variations the user should perform qualification testing based on the conditions outlined in IPC standard 7351 (IPC-7351).

¹ Height of these chips may create problems in wave soldering.

² Land pattern geometry is too small for silkscreen outline.

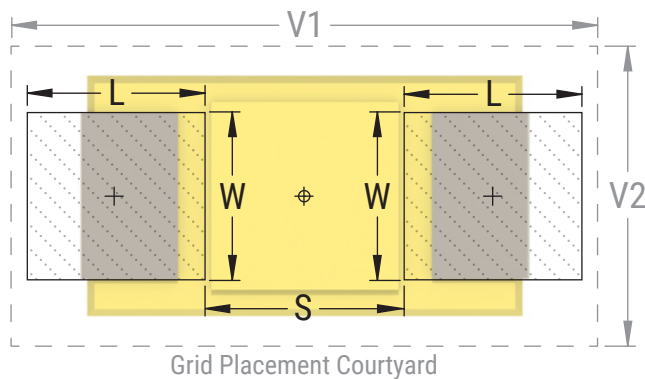

Soldering Process

The KEMET families of surface mount capacitors are compatible with wave (single or dual), convection, IR, or vapor phase reflow techniques. Preheating of these components is recommended to avoid extreme thermal stress. KEMET's recommended profile conditions for convection and IR reflow reflect the profile conditions of the IPC/J-STD-020D standard for moisture sensitivity testing. The devices can safely withstand a maximum of three reflow passes at these conditions.

Please note that although the X/7343-43 case size can withstand wave soldering, the tall profile (4.3 mm maximum) dictates care in wave process development.

Hand soldering should be performed with care due to the difficulty in process control. If performed, care should be taken to avoid contact of the soldering iron to the molded case. The iron should be used to heat the solder pad, applying solder between the pad and the termination, until reflow occurs. Once reflow occurs, the iron should be removed immediately. "Wiping" the edges of a chip and heating the top surface is not recommended.

During typical reflow operations, a slight darkening of the gold-colored epoxy may be observed. This slight darkening is normal and not harmful to the product. Marking permanency is not affected by this change.

Profile Feature	SnPb Assembly	Pb-Free Assembly
Preheat/Soak		
Temperature Minimum (T_{smin})	100°C	150°C
Temperature Maximum (T_{smax})	150°C	200°C
Time (t_s) from T_{smin} to T_{smax}	60 – 120 seconds	60 – 120 seconds
Ramp-up Rate (T_L to T_P)	3°C/second maximum	3°C/second maximum
Liquidous Temperature (T_L)	183°C	217°C
Time Above Liquidous (t_L)	60 – 150 seconds	60 – 150 seconds
Peak Temperature (T_P)	220°C* 235°C**	250°C* 260°C**
Time within 5°C of Maximum Peak Temperature (t_p)	20 seconds maximum	30 seconds maximum
Ramp-down Rate (T_P to T_L)	6°C/second maximum	6°C/second maximum
Time 25°C to Peak Temperature	6 minutes maximum	8 minutes maximum

Note: All temperatures refer to the center of the package, measured on the package body surface that is facing up during assembly reflow.

* For Case Size height > 2.5 mm

** For Case Size height ≤ 2.5 mm

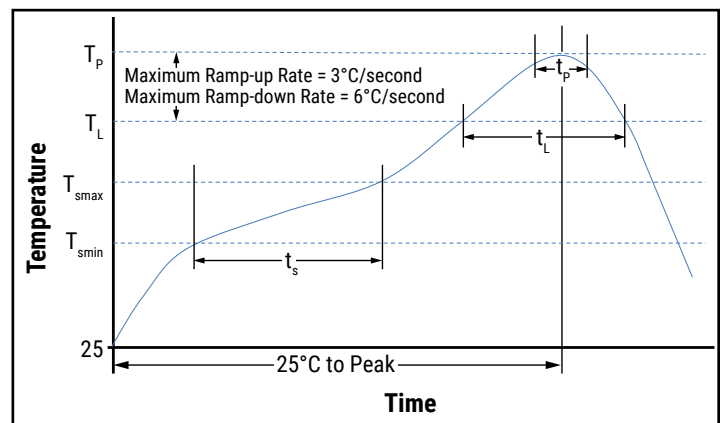

Storage

Tantalum chip capacitors should be stored in normal working environments. While the chips themselves are quite robust in other environments, solderability will be degraded by exposure to high temperatures, high humidity, corrosive atmospheres, and long term storage. In addition, packaging materials will be degraded by high temperature – reels may soften or warp and tape peel force may increase. KEMET recommends that maximum storage temperature not exceed 40°C and maximum storage humidity not exceed 60% relative humidity. Temperature fluctuations should be minimized to avoid condensation on the parts and atmospheres should be free of chlorine and sulphur bearing compounds. For optimized solderability, chip stock should be used promptly, preferably within three years of receipt.

Construction

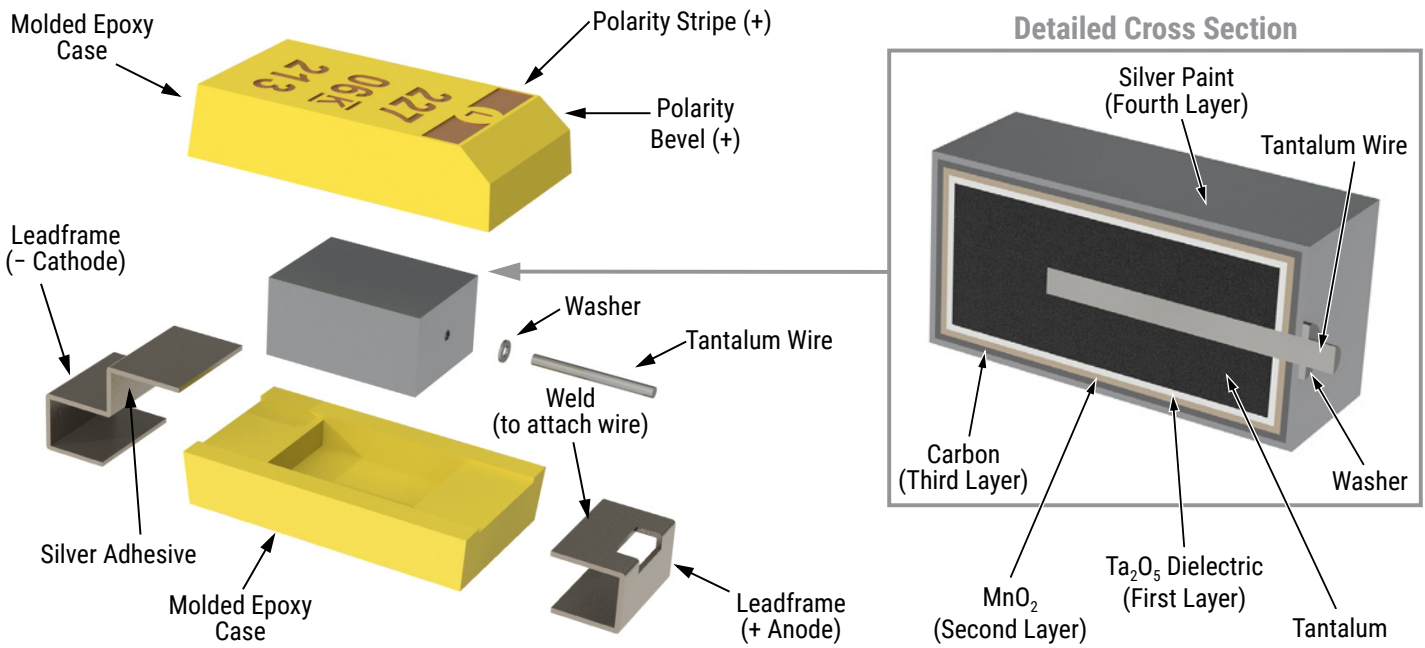

Capacitor Marking

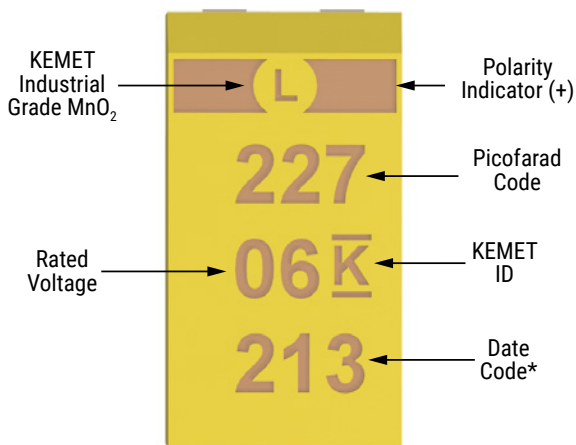

* 213 = 13th week of 2022

Date Code *	
1 st digit = last number of year	8 = 2018 9 = 2019 0 = 2020 1 = 2021 2 = 2022
2 nd and 3 rd digit = week of the year	01 = 1 st week of the year to 52 = 52 nd week of the year

Tape & Reel Packaging Information

KEMET’s molded chip capacitor families are packaged in 8 and 12 mm plastic tape on 7" and 13" reels in accordance with *EIA Standard 481: Embossed Carrier Taping of Surface Mount Components for Automatic Handling*. This packaging system is compatible with all tape-fed automatic pick-and-place systems.

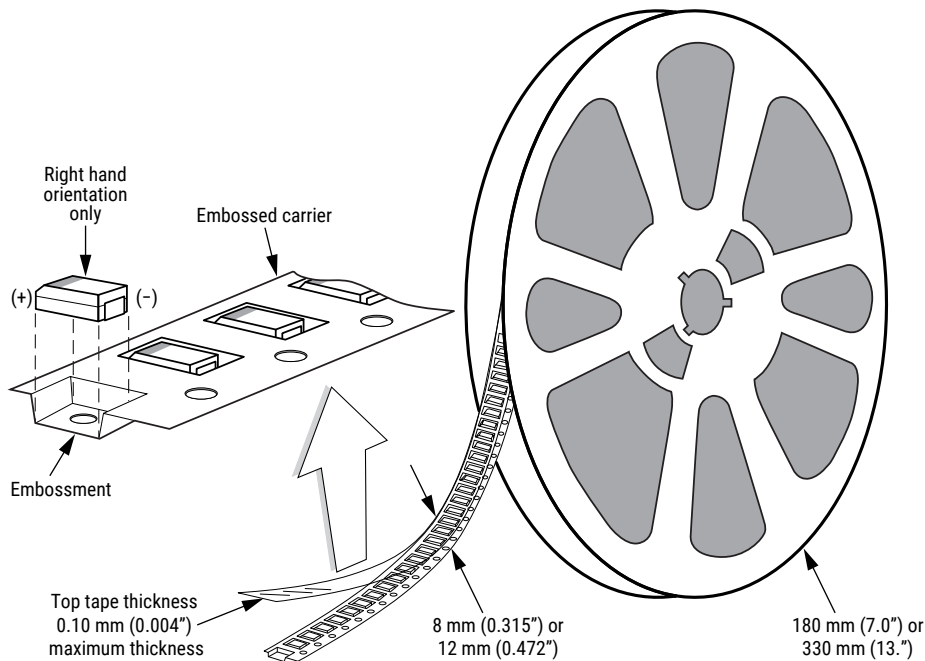

Table 3 – Packaging Quantity

Case Code		Tape Width (mm)	7" Reel*	13" Reel*
KEMET	EIA			
S	3216-12	8	2,500	10,000
T	3528-12	8	3,000	10,000
M	3528-15	8	2,500	8,000
U	6032-15	12	1,000	5,000
L	6032-19	12	1,000	3,000
W	7343-15	12	1,000	3,000
Z	7343-17	12	1,000	3,000
V	7343-20	12	1,000	3,000
A	3216-18	8	2,000	9,000
B	3528-21	8	2,000	8,000
C	6032-28	12	500	3,000
D	7343-31	12	500	2,500
Q	7343-12	12	1,000	3,000
Y	7343-40	12	500	2,000
X	7343-43	12	500	2,000
E/T428P	7360-38	12	500	2,000
H	7360-20	12	1,000	2,500
O	7360-43	12	250	1,000

* No C-Spec required for 7" reel packaging. C-7280 required for 13" reel packaging.

Figure 1 – Embossed (Plastic) Carrier Tape Dimensions

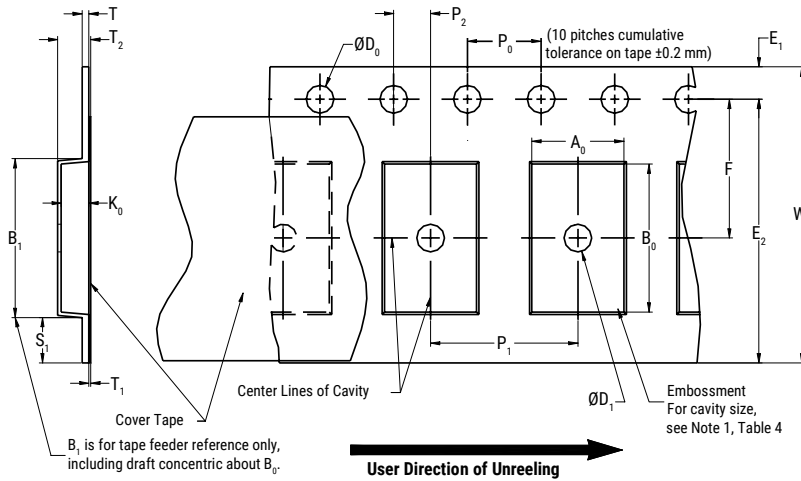

Table 4 – Embossed (Plastic) Carrier Tape Dimensions

Metric will govern

Constant Dimensions – Millimeters (Inches)									
Tape Size	D ₀	D ₁ Minimum Note 1	E ₁	P ₀	P ₂	R Reference Note 2	S ₁ Minimum Note 3	T Maximum	T ₁ Maximum
8 mm	1.5 +0.10/-0.0 (0.059 +0.004/-0.0)	1.0 (0.039)	1.75 ±0.10 (0.069 ±0.004)	4.0 ±0.10 (0.157 ±0.004)	2.0 ±0.05 (0.079 ±0.002)	25.0 (0.984)	0.600 (0.024)	0.600 (0.024)	0.100 (0.004)
12 mm		1.5 (0.059)							

Variable Dimensions – Millimeters (Inches)									
Tape Size	Pitch	B ₁ Maximum Note 4	E ₂ Minimum	F	P ₁	T ₂ Maximum	W Maximum	A ₀ , B ₀ & K ₀	
8 mm	Single (4 mm)	4.35 (0.171)	6.25 (0.246)	3.5 ±0.05 (0.138 ±0.002)	2.0 ±0.05 or 4.0 ±0.10 (0.079 ±0.002 or 0.157 ±0.004)	2.5 (0.098)	8.3 (0.327)	Note 5	
12 mm	Single (4 mm) and Double (8 mm)	8.2 (0.323)	10.25 (0.404)	5.5 ±0.05 (0.217 ±0.002)	2.0 ±0.05 (0.079 ±0.002) or 4.0 ±0.10 (0.157 ±0.004) or 8.0 ±0.10 (0.315 ±0.004)	4.6 (0.181)	12.3 (0.484)		

1. The embossment hole location shall be measured from the sprocket hole controlling the location of the embossment. Dimensions of embossment location and hole location shall be applied independent of each other.
2. The tape, with or without components, shall pass around R without damage (see Figure 4).
3. If S₁ < 1.0 mm, there may not be enough area for cover tape to be properly applied (see EIA Standard 481-D, paragraph 4.3, section b).
4. B₁ dimension is a reference dimension for tape feeder clearance only.
5. The cavity defined by A₀, B₀ and K₀ shall surround the component with sufficient clearance that:
 - (a) the component does not protrude above the top surface of the carrier tape.
 - (b) the component can be removed from the cavity in a vertical direction without mechanical restriction, after the top cover tape has been removed.
 - (c) rotation of the component is limited to 20° maximum for 8 and 12 mm tapes (see Figure 2).
 - (d) lateral movement of the component is restricted to 0.5 mm maximum for 8 mm and 12 mm wide tape (see Figure 3).
 - (e) see Addendum in EIA Standard 481-D for standards relating to more precise taping requirements.

Packaging Information Performance Notes

- 1. Cover tape break force:** 1.0 kg minimum.
- 2. Cover tape peel strength:** The total peel strength of the cover tape from the carrier tape shall be:

Tape Width	Peel Strength
8 mm	0.1 to 1.0 newton (10 to 100 gf)
12 mm	0.1 to 1.3 newton (10 to 130 gf)

The direction of the pull shall be opposite the direction of the carrier tape travel. The pull angle of the carrier tape shall be 165° to 180° from the plane of the carrier tape. During peeling, the carrier and/or cover tape shall be pulled at a velocity of 300 ±10 mm/minute.

- 3. Labeling:** Bar code labeling (standard or custom) shall be on the side of the reel opposite the sprocket holes. Refer to EIA Standards 556 and 624.

Figure 2 – Maximum Component Rotation

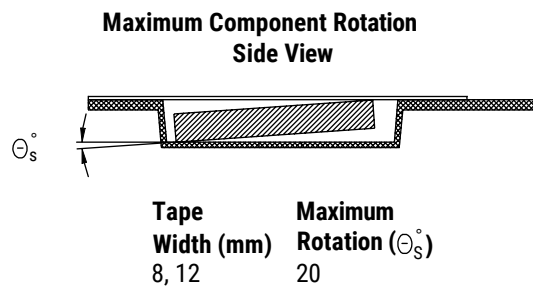
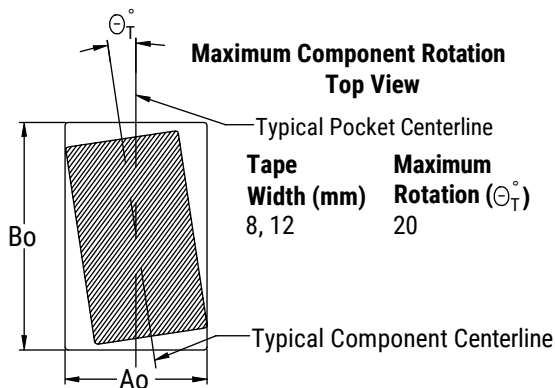

Figure 3 – Maximum Lateral Movement

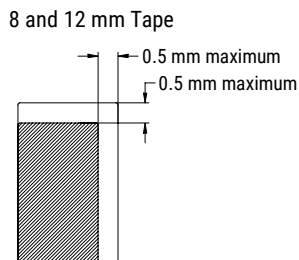

Figure 4 – Bending Radius

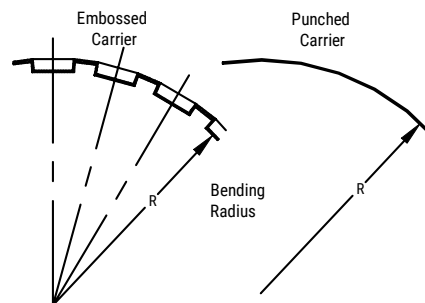

Figure 5 – Reel Dimensions



Note: Drive spokes optional; if used, dimensions B and D shall apply.

Table 5 – Reel Dimensions

Metric will govern

Constant Dimensions – Millimeters (Inches)				
Tape Size	A	B Minimum	C	D Minimum
8 mm	178 ±0.20 (7.008 ±0.008)	1.5 (0.059)	13.0 +0.5/-0.2 (0.521 +0.02/-0.008)	20.2 (0.795)
12 mm	330 ±0.20 (13.000 ±0.008)			
Variable Dimensions – Millimeters (Inches)				
Tape Size	N Minimum	W ₁	W ₂ Maximum	W ₃
8 mm	50 (1.969)	8.4 +1.5/-0.0 (0.331 +0.059/-0.0)	14.4 (0.567)	Shall accommodate tape width without interference
12 mm		12.4 +2.0/-0.0 (0.488 +0.078/-0.0)	18.4 (0.724)	

Figure 6 – Tape Leader & Trailer Dimensions

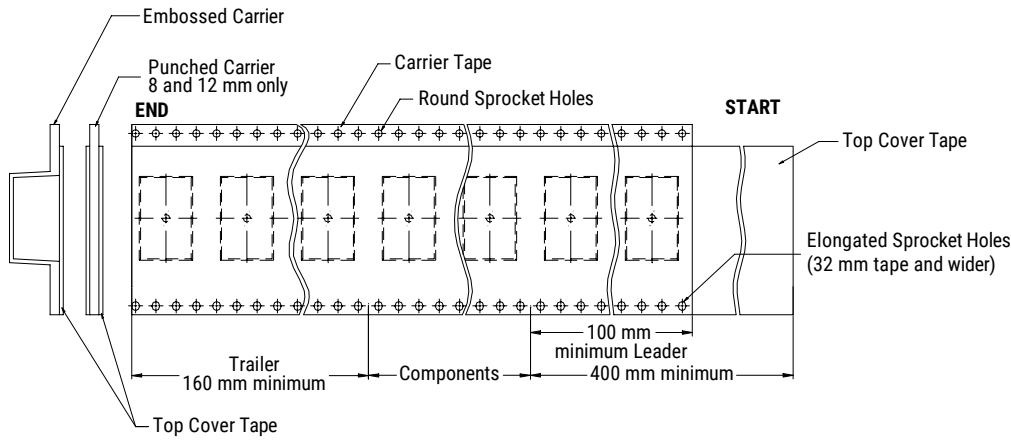
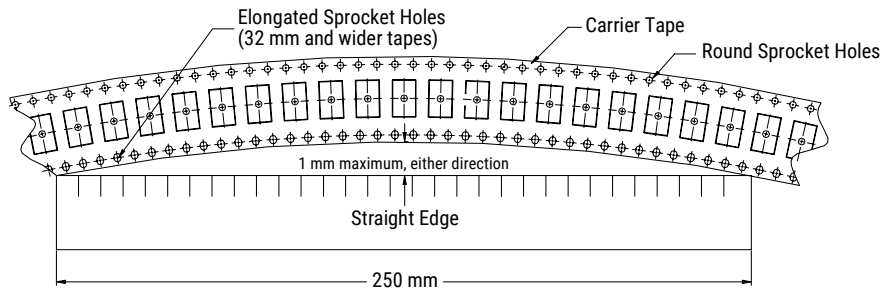

Figure 7 – Maximum Camber



KEMET Electronics Corporation Sales Offices

For a complete list of our global sales offices, please visit www.kemet.com/sales.

Disclaimer

All product specifications, statements, information and data (collectively, the "Information") in this datasheet are subject to change. The customer is responsible for checking and verifying the extent to which the Information contained in this publication is applicable to an order at the time the order is placed. All Information given herein is believed to be accurate and reliable, but it is presented without guarantee, warranty, or responsibility of any kind, expressed or implied.

Statements of suitability for certain applications are based on KEMET Electronics Corporation's ("KEMET") knowledge of typical operating conditions for such applications, but are not intended to constitute – and KEMET specifically disclaims – any warranty concerning suitability for a specific customer application or use. The Information is intended for use only by customers who have the requisite experience and capability to determine the correct products for their application. Any technical advice inferred from this Information or otherwise provided by KEMET with reference to the use of KEMET's products is given gratis, and KEMET assumes no obligation or liability for the advice given or results obtained.

Although KEMET designs and manufactures its products to the most stringent quality and safety standards, given the current state of the art, isolated component failures may still occur. Accordingly, customer applications which require a high degree of reliability or safety should employ suitable designs or other safeguards (such as installation of protective circuitry or redundancies) in order to ensure that the failure of an electrical component does not result in a risk of personal injury or property damage.

Although all product-related warnings, cautions and notes must be observed, the customer should not assume that all safety measures are indicated or that other measures may not be required.

KEMET is a registered trademark of KEMET Electronics Corporation.

单击下面可查看定价，库存，交付和生命周期等信息

[>>KEMET\(基美\)](#)