

KEMET Part Number: CAN22X563JAGACTU
(CAN22X563JAGAC7800)

CAN SMD Indust 250, Ceramic, 0.056 uF, 5%, COG, SMD Chip, MLCC, AC Rated, 2225

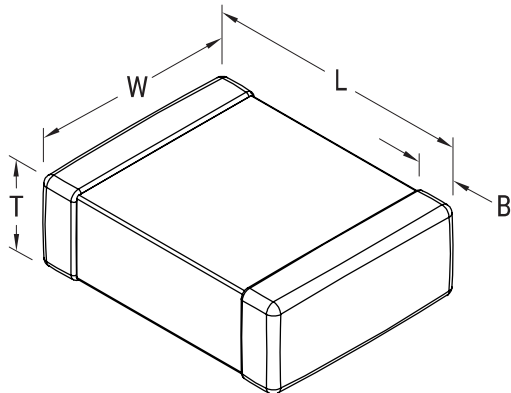

General Information	
Series:	CAN SMD Indust 250
Style:	SMD Chip
Description:	SMD Chip, MLCC, AC Rated
Features:	Temperature Stable, Class I
RoHS:	Yes
Termination:	Flexible Termination
Marking:	No
AEC-Q200:	No
MSL:	1

Dimensions	
Chip Size	2225
L	5.9mm +/-0.75mm
W	6.4mm +/-0.4mm
T	1.4mm +/-0.15mm
B	0.7mm +/-0.35mm

Packaging Specifications	
Packaging:	T&R, 180mm, Paper Tape
Packaging Quantity:	1000

Specifications	
Capacitance:	0.056 uF
Measurement Condition:	1 kHz 1.0Vrms
Capacitance Tolerance:	5%
Voltage AC:	250 VAC
Dielectric Withstanding Voltage:	945 VDC
Temperature Range:	-55/+125°C
Temperature Coefficient:	COG
Capacitance Change with Reference to +25°C and 0 VDC Applied (TCC):	15%, 1kHz 1.0Vrms
Dissipation Factor:	0.1% 1 kHz 1.0Vrms
Aging Rate:	0% Loss/Decade Hour
Insulation Resistance:	10 GOhms

单击下面可查看定价，库存，交付和生命周期等信息

[>>KEMET\(基美\)](#)