

**KEMET Part Number: MMK5273J250J02L16.5TA16**  
(F601JJ273J250Q, MMK5273J250J02L16,5TA16)

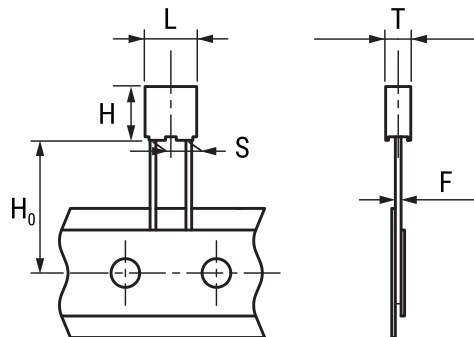

MMK/F601, Film, Metallized Polyester, General Purpose, 0.027 uF, 5%, 250 VDC, 85°C, Lead Spacing = 5mm



General Information	
Series:	MMK/F601
Dielectric:	Metallized Polyester
Style:	Radial
Features:	DC Multipurpose Applications
RoHS:	Yes
Lead:	Wire Leads
AEC-Q200:	No
Notes:	Not For New Design, Please Check Possible Alternative Parts (AltPart).

Dimensions	
L	7.2mm MAX
H	8mm MAX
T	3.5mm MAX
S	5mm +0.6/-0.1mm
H <sub>0</sub>	16mm NOM
F	0.5mm NOM

Specifications	
Capacitance:	0.027 uF
Capacitance Tolerance:	5%
Voltage AC:	160 VAC
Voltage DC:	250 VDC, 193.8 VDC (100C)
Temperature Range:	-55/+100°C
Rated Temperature:	85°C
Dissipation Factor:	0.8% 1kHz, 1.2% 10kHz, 2.5% 100kHz
Insulation Resistance:	30 GOhms
Max dV/dt:	40 V/us
Inductance:	6 nH

Packaging Specifications	
Packaging:	Ammo, 330x330x50mm, Box
Packaging Quantity:	4000

Statements of suitability for certain applications are based on our knowledge of typical operating conditions for such applications, but are not intended to constitute - and we specifically disclaim - any warranty concerning suitability for a specific customer application or use. This Information is intended for use only by customers who have the requisite experience and capability to determine the correct products for their application. Any technical advice inferred from this Information or otherwise provided by us with reference to the use of our products is given gratis, and we assume no obligation or liability for the advice given or results obtained.



单击下面可查看定价，库存，交付和生命周期等信息

[>>KEMET\(基美\)](#)