

EXV, Aluminum Electrolytic, 150 uF, 20%, 80 VDC, -40/+105°C

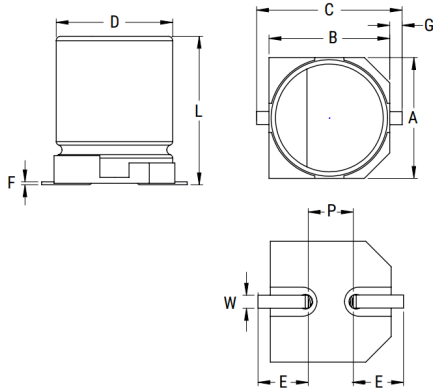

Dimensions	
D	12.5mm +/-0.5mm
L	13.5mm +/-0.5mm
W	1.25mm +/-0.2mm
F	0.3mm MAX
A	12.8mm +/-0.2mm
B	12.8mm +/-0.2mm
C	15.2mm MAX
E	4.9mm +/-0.2mm
G	1mm +/-0.2mm
P	4.6mm +/-0.2mm

Packaging Specifications	
Packaging:	T&R, 380mm
Packaging Quantity:	200

General Information	
Series:	EXV
Dielectric:	Aluminum Electrolytic
Style:	SMD Can
Description:	Surface Mount, Aluminum Electrolytic
RoHS:	Yes
Lead:	V-Chip
AEC-Q200:	No

Specifications	
Capacitance:	150 uF
Capacitance Tolerance:	20%
Voltage DC:	80 VDC, 100 VDC (Surge)
Temperature Range:	-40/+105°C
Rated Temperature:	105°C
Life:	5000 Hrs
Dissipation Factor:	12% 120Hz 20C
Resistance:	0.6 Ohms (100kHz 20C)
Ripple Current:	400 mAmps (100kHz 105C)
Leakage Current:	120 uA (2min 20°C)
High Temperature Solder:	Yes

Statements of suitability for certain applications are based on our knowledge of typical operating conditions for such applications, but are not intended to constitute - and we specifically disclaim - any warranty concerning suitability for a specific customer application or use. This Information is intended for use only by customers who have the requisite experience and capability to determine the correct products for their application. Any technical advice inferred from this Information or otherwise provided by us with reference to the use of our products is given gratis, and we assume no obligation or liability for the advice given or results obtained.

单击下面可查看定价，库存，交付和生命周期等信息

[>>KEMET\(基美\)](#)