

KEMET Part Number: T493D336K035BH6210
(07016-152KBHB, DLA Drawing 07016-152KBHB)

T493 HRA, Tantalum, MnO2 Tantalum, HRA, 33 uF, 10%, 35 VDC, SMD, MnO2, Molded, DLA Drawing, B (0.1%/1000 Hrs), 300 mOhms, 7343, Height Max = 3.1mm

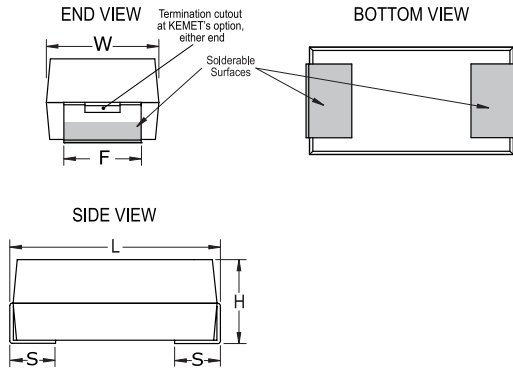

Dimensions	
Footprint	7343
L	7.3mm +/-0.3mm
W	4.3mm +/-0.3mm
H	2.8mm +/-0.3mm
S	1.3mm +/-0.3mm
F	2.4mm +/-0.1mm

Packaging Specifications	
Packaging:	T&R, 178mm
Packaging Quantity:	500

General Information	
Series:	T493 HRA
Dielectric:	MnO2 Tantalum
Style:	SMD Chip
Description:	SMD, MnO2, Molded, DLA Drawing
Features:	High Reliability
RoHS:	No
Prop 65:	WARNING: Cancer and reproductive harm - www.p65warnings.ca.gov
Termination:	Solder Coated
AEC-Q200:	No
Component Weight:	412.33 mg

Specifications	
Capacitance:	33 uF
Capacitance Tolerance:	10%
Voltage DC:	35 VDC (85C), 23.45 VDC (125C)
Temperature Range:	-55/+125°C
Rated Temperature:	85°C
Dissipation Factor:	6% 120Hz 25C
Failure Rate:	B (0.1%/1000 Hrs)
Resistance:	0.3 Ohms (100kHz 25C)
Leakage Current:	11.6 uA (5min 25°C)
Testing and Reliability:	10 Cycles Surge Current Testing At +25C After Weibull

单击下面可查看定价，库存，交付和生命周期等信息

[>>KEMET\(基美\)](#)