

## M123A11BPB242FS

Aliases (C1210Z242F5GAH)

SMD Mil PRF123, Ceramic, 2400 pF, 1%, 50 VDC, BP, SMD Chip, Ultra Stable, N/A, 1210

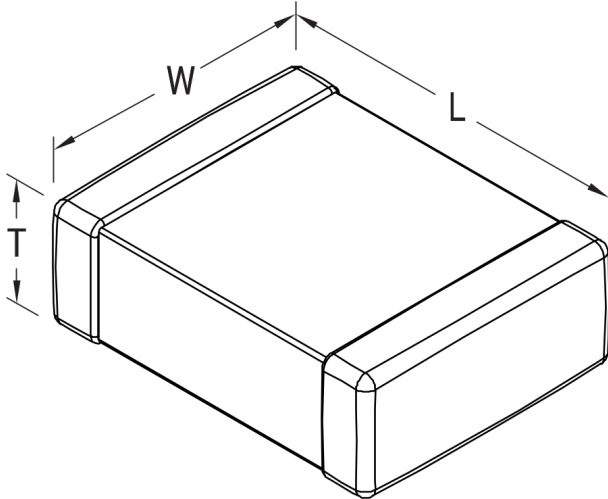

Click [here](#) for the 3D model.

### Dimensions

Chip Size	1210
L	3.048mm +/-0.381mm (0.12 in +/-0.015 in)
W	2.54mm +/-0.381mm (0.1 in +/-0.015 in)
T	1.651mm MAX (0.065 in MAX)

### Packaging Specifications

Packaging	Waffle
Packaging Quantity	25000

### General Information

Series	SMD Mil PRF123
Style	SMD Chip
Description	SMD Chip, Ultra Stable
RoHS	No
Prop 65	<b>⚠ WARNING:</b> Cancer and reproductive harm - <a href="http://www.p65warnings.ca.gov">http://www.p65warnings.ca.gov</a> .
SCIP Number	646e40c8-ce81-456e-b9ed-50112f3d27a5
Termination	Nickel
Failure Rate	N/A
AEC-Q200	No
Shelf Life	78 Weeks
MSL	1

### Specifications

Capacitance	2400 pF
Capacitance Tolerance	1%
Voltage DC	50 VDC
Dielectric Withstanding Voltage	125 VDC
Temperature Range	-55/+125°C
Temperature Coefficient	BP
Capacitance Change with Reference to +25°C and 0 VDC Applied (TCC)	15%, 1kHz 1.0Vms
Dissipation Factor	2.5%
Insulation Resistance	100 GOhms

Statements of suitability for certain applications are based on our knowledge of typical operating conditions for such applications, but are not intended to constitute - and we specifically disclaim - any warranty concerning suitability for a specific customer application or use. This information is intended for use only by customers who have the requisite experience and capability to determine the correct products for their application. Any technical advice inferred from this information or otherwise provided by us with reference to the use of our products is given gratis, and we assume no obligation or liability for the advice given or results obtained.

单击下面可查看定价，库存，交付和生命周期等信息

[>>KEMET\(基美\)](#)