

## TRS5-30BCR01

Aliases (USEE30BCR01000)

KEMET, TRS, Thermal Reed Switch, Axial, 2.5C Temperature Accuracy, High Reliability, High-Speed Response, Long Operational Life, Excellent Environmental Durability, High Temperature Accuracy, 30°C, Break

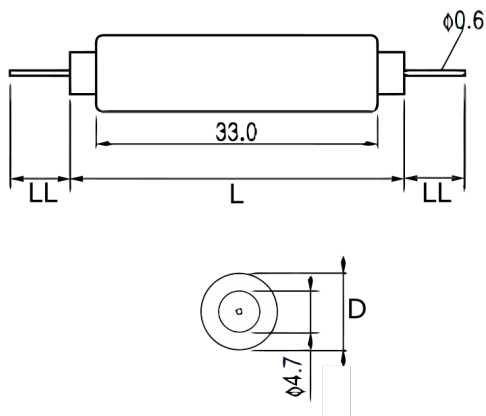

Click [here](#) for the 3D model.

### Dimensions

D	7mm NOM
L	40mm NOM
LL	8.5mm NOM

### Packaging Specifications

Packaging	Tray, Box
Packaging Quantity	600
Component Weight	3.1g

### General Information

Series	TRS
Type	Thermal Reed Switch
Style	Axial
Description	Thermal Reed Switch
Features	High Reliability, High-Speed Response, Long Operational Life, Excellent Environmental Durability, High Temperature Accuracy
Lead	Wire Leads
RoHS	Yes

### Specifications

Switching Temperature	30C +/-2.5C
Temperature Range	-20/+130°C
Contact Type	Break
Voltage DC	200 VDC MAX (Opening/Closing), 1500 VAC/1 minute or 1800 VAC/1 second
Voltage AC	140 VAC MAX (Opening/Closing)
Current	0.55 Amps AC/DC MAX (Opening/Closing), 1 mAmps MIN (5VDC, Opening/Closing)
Resistance	150 mOhms MAX (Contact Resistance)
Max Opening/Closing Power	60.5 W (AC/DC); 10 W (DC)
Max Opening/Closing Voltage	140 V (AC); 200 V (DC)
Differential Temperature	10C Maximum

Statements of suitability for certain applications are based on our knowledge of typical operating conditions for such applications, but are not intended to constitute - and we specifically disclaim - any warranty concerning suitability for a specific customer application or use. This information is intended for use only by customers who have the requisite experience and capability to determine the correct products for their application. Any technical advice inferred from this information or otherwise provided by us with reference to the use of our products is given gratis, and we assume no obligation or liability for the advice given or results obtained.

单击下面可查看定价，库存，交付和生命周期等信息

[>>KEMET\(基美\)](#)