

Overview

The KEMET T419 is approved to MIL-PRF-55365/11 (CWR19 Style) with Weibull failure rates of B level (0.1% failures per 1,000 hours), C level (0.01% failures per 1,000 hours), D level (0.001% failures per 1,000 hours), or T level (0.01% failures per 1,000 hours, Option C surge current, DPA, radiographic inspection, 100% visual

inspection, DCL and ESR measurements within +3 standard deviations, and Group C inspection). This CWR19 product is a precision-molded device with compliant terminations and indelible laser marking. Tape & Reel packaging per EIA 481 is standard.

Benefits

- Established reliability options
- Tape & Reel standard packaging per EIA 481
- Symmetrical, compliant terminations
- Laser-marked case
- 100% surge current test available on all case sizes
- Qualified to MIL-PRF-55365/11 (CWR19 Style)
- Termination options B, C, H, and K
- Weibull failure options B, C, D, and T
- Exponential failure rates M, P, R, and S
- Voltage rating of 4 – 35 VDC
- Operating temperature range of -55°C to +125°C

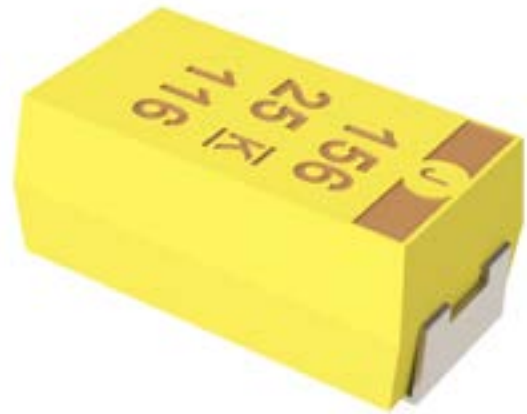

Applications

Typical applications include decoupling and filtering in military and aerospace applications requiring CWR19 devices.

Environmental Compliance

- Halogen-free
- Epoxy compliant with UL94 V-0
- Molded Epoxy complies for outgassing testing under ASTM E 595.

K-SIM

For a detailed analysis of specific part numbers, please visit ksim.kemet.com to access KEMET's K-SIM software. KEMET K-SIM is designed to simulate behavior of components with respect to frequency, ambient temperature, and DC bias levels.

KEMET Ordering Information

T	419	A	225	K	004	A	H	4251	7280
Capacitor Class	Series	Case Size	Capacitance Code (pF)	Capacitance Tolerance	Rated Voltage (VDC)	Failure Rate/Design	Termination Finish	Surge	Packaging (C-Spec)
T = Tantalum	CWR19 Established reliability	A B C D E F G H X	First two digits represent significant figures. Third digit specifies number of zeros.	J = ±5% K = ±10% M = ±20%	004 = 4 006 = 6 010 = 10 015 = 15 020 = 20 025 = 25 035 = 35	Weibull A = Non-ER B = (0.1%/1,000 hours) C = (0.01%/1,000 hours) D = (0.001%/1,000 hours) T = T Level* (0.01%/1,000 hours) Exponential M = (1.0%/1,000 hours) P = (0.1%/1,000 hours) R = (0.01%/1,000 hours) S = (0.001%/1,000 hours)	C = Hot solder dipped H = Standard solder-coated (SnPb 5% Pb minimum) B = Gold-plated K = Solder-fused	Blank = No surge 4250 = 25°C after Weibull 4251 = -55°C and 85°C after Weibull 4252 = -55°C and 85°C before Weibull TLVL = Weibull grade level "T"	Blank = 7" Reel 7280 = 13" Reel 7610 = Bulk bag 7640 = Bulk plastic box WAFI = Waffle pack

Ordering Information – Defense MIL-PRF-55365/11

CWR19	K	H	225	K	C	D	A
Capacitor Style	Rated Voltage (VDC)	Termination Finish	Capacitance Code (pF)	Capacitance Tolerance	Reliability Level	Case Code	Surge Current Option
Per MIL-PRF-55365/11	C = 4 D = 6 F = 10 H = 15 J = 20 K = 25 M = 35	B = Gold-plated C = Hot solder dipped H = Solder-plated K = Solder-fused	First two digits represent significant figures. Third digit specifies number of zeros.	J = ±5% K = ±10% M = ±20%	Weibull A = Non-ER B = (0.1%/1,000 hours) C = (0.01%/1,000 hours) D = (0.001%/1,000 hours) T = T Level* (0.01%/1,000 hours) Exponential M = (1.0%/1,000 hours) P = (0.1%/1,000 hours) R = (0.01%/1,000 hours) S = (0.001%/1,000 hours)	A B C D E F G H X	A = +25°C after Weibull B = -55°C +85°C after Weibull C = -55°C +85°C before Weibull Z = None

* When T Level is ordered, no Surge Current Option is needed

Performance Characteristics

Item	Performance Characteristics
Operating Temperature	-55°C to 125°C
Rated Capacitance Range	0.33 – 330 µF at 120 Hz/25°C
Capacitance Tolerance	J Tolerance (5%), K Tolerance (10%), M Tolerance (20%)
Rated Voltage Range	4 – 35 V
DF (120 Hz)	Refer to Part Number Electrical Specification Table
ESR (100 kHz)	Refer to Part Number Electrical Specification Table
Leakage Current	≤ 0.01 CV (µA) at rated voltage after 5 minutes

Qualification

Test	Condition	Characteristics				
Endurance	85°C at rated voltage, 2,000 hours 125°C at 2/3 rated voltage, 2,000 hours	Δ C/C	Within ±10% of initial value			
		DF	Within initial limits			
		DCL	Within 1.25 x initial limit			
		ESR	Within initial limits			
Storage Life	125°C at 0 volts, 2,000 hours	Δ C/C	Within ±10% of initial value			
		DF	Within initial limits			
		DCL	Within 1.25 x initial limit			
		ESR	Within initial limits			
Thermal Shock	MIL-STD-202, Method 107, Condition B, mounted, -55°C to 125°C, 1,000 cycles	Δ C/C	Within ±5% of initial value			
		DF	Within initial limits			
		DCL	Within 1.25 x initial limit			
		ESR	Within initial limits			
Temperature Stability	Extreme temperature exposure at a succession of continuous steps at +25°C, -55°C, +25°C, +85°C, +125°C, +25°C	Δ C/C	+25°C	-55°C	+85°C	+125°C
		DF	IL*	±10%	±10%	±15%
		DCL	IL	IL	1.5 x IL	1.5 x IL
Surge Voltage	25°C and 85°C, 1.32 x rated voltage 1,000 cycles (125°C, 1.2 x rated voltage)	Δ C/C	Within ±5% of initial value			
		DF	Within initial limits			
		DCL	Within initial limits			
		ESR	Within initial limits			
Mechanical Shock/Vibration	MIL-STD-202, Method 213, Condition I, 100 G Peak MIL-STD-202, Method 204, Condition D, 10 Hz to 2,000 Hz, 20 G peak	Δ C/C	Within ±10% of initial value			
		DF	Within initial limits			
		DCL	Within initial limits			
Additional qualification tests per MIL-PRF-55365/11	Please contact KEMET for more information.					

*IL = Initial limit

Certification

MIL-PRF-55365/11

Electrical Characteristics

ESR vs. Frequency

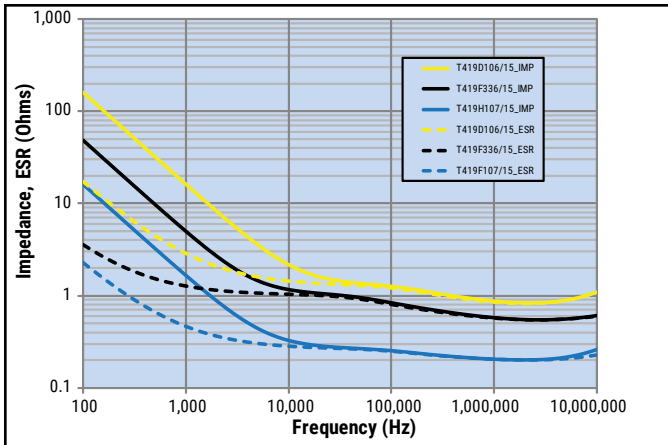

Capacitance vs. Frequency

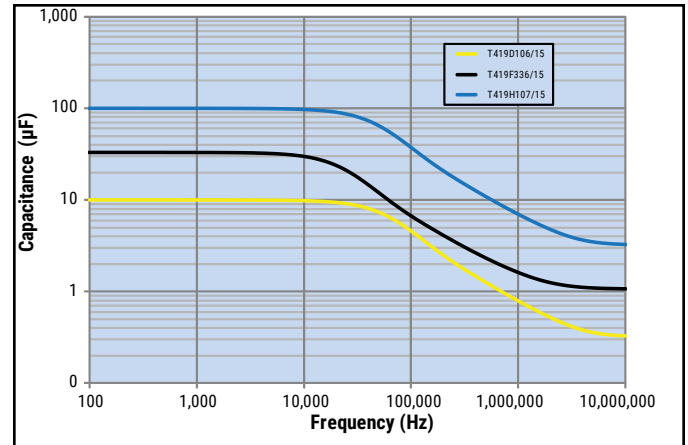

Dimensions – Millimeters (Inches)

Metric will govern

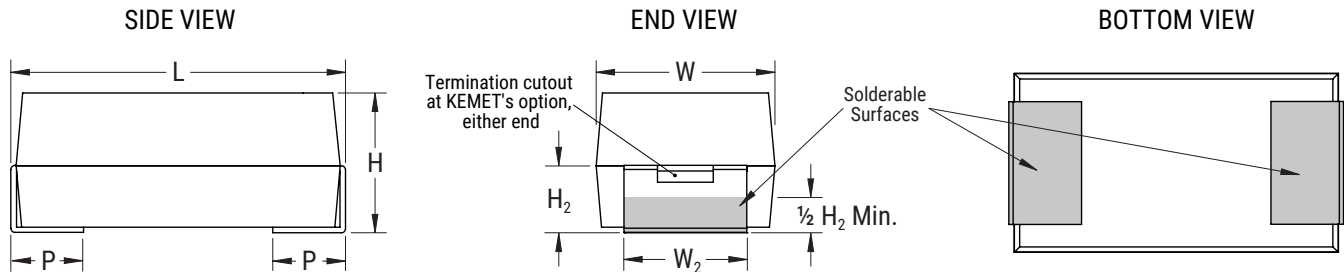

Case Size	Component						Typical Weight
KEMET	L ±0.38 (0.015)	W ±0.38 (0.015)	H ±0.38 (0.015)	P +0.25 (0.010), -0.13 (0.005)	W ₂	H ₂ Minimum	(mg)
A	2.54 (0.100)	1.27 (0.050)	1.27 (0.050)	0.76 (0.030)	1.27 ±0.13 (0.050 ±0.005)	0.76 (0.030)	39.91
B	3.81 (0.150)	1.27 (0.050)	1.27 (0.050)	0.76 (0.030)	1.27 ±0.13 (0.050 ±0.005)	0.76 (0.030)	68.73
C	5.08 (0.200)	1.27 (0.050)	1.27 (0.050)	0.76 (0.030)	1.27 ±0.13 (0.050 ±0.005)	0.76 (0.030)	146.5
D	3.81 (0.150)	2.54 (0.100)	1.27 (0.050)	0.76 (0.030)	2.41 +0.13, -0.25 (0.095 +0.005, -0.010)	0.76 (0.030)	264.12
E	5.08 (0.200)	2.54 (0.100)	1.27 (0.050)	0.76 (0.030)	2.41 +0.13, -0.25 (0.095 +0.005, -0.010)	0.76 (0.030)	421.63
F	5.59 (0.220)	3.43 (0.135)	1.78 (0.070)	0.76 (0.030)	3.30 ±0.13 (0.130 ±0.005)	1.02 (0.040)	173.63
G	6.73 (0.265)	2.79 (0.110)	2.79 (0.110)	1.27 (0.050)	2.67 ±0.13 (0.105 ±0.005)	1.52 (0.060)	266.42
H	7.24 (0.285)	3.81 (0.150)	2.79 (0.110)	1.27 (0.050)	3.68 +0.013, -0.51 (0.145 +0.005, -0.020)	1.52 (0.060)	349.01
X	6.93 (0.273)	5.41 (0.213)	2.74 (0.108)	1.19 (0.047)	3.05 ±0.13 (0.120 ±0.005)	1.22 (0.048)	590.44

Note: When solder coated terminations are required, add an additional 0.38 mm (0.015 inch) to the above tolerances for "L", "W", "H", "P", "W₂", and "H₂". These weights are provided as reference. If exact weights are needed, please contact your KEMET sales representative.

Table 1 – Ratings & Part Number Reference

Rated Voltage	Rated Cap	Case Code/ Case Size	KEMET Part Number	MIL-PRF-55365/11 Part Number	DC Leakage	DF	ESR	Maximum Operating Temp	MSL
VDC at 85°C	µF	KEMET/EIA	(See below for part options)	(See below for part options)	µA at +25°C Max/5 Min	% at 25°C 120 Hz Max	Ω at +25°C 100 kHz Max	°C	Reflow Temp ≤ 260°C
4	3.3	A/1005	T419A335(1)004(2)(3)(4)	CWR19C(3)335(1)(2)A(5)	1.0	6.0	12.0	125	1
4	4.7	A/1005	T419A475(1)004(2)(3)(4)	CWR19C(3)475(1)(2)A(5)	1.0	6.0	12.0	125	1
4	6.8	A/1005	T419A685(1)004(2)(3)(4)	CWR19C(3)685(1)(2)A(5)	1.0	6.0	12.0	125	1
4	10	B/1505	T419B106(1)004(2)(3)(4)	CWR19C(3)106(1)(2)B(5)	1.0	8.0	8.0	125	1
4	15	B/1505	T419B156(1)004(2)(3)(4)	CWR19C(3)156(1)(2)B(5)	1.0	8.0	8.0	125	1
4	22	B/1505	T419B226(1)004(2)(3)(4)	CWR19C(3)226(1)(2)B(5)	1.0	8.0	8.0	125	1
4	22	D/1510	T419D226(1)004(2)(3)(4)	CWR19C(3)226(1)(2)D(5)	1.0	8.0	4.0	125	1
4	33	D/1510	T419D336(1)004(2)(3)(4)	CWR19C(3)336(1)(2)D(5)	2.0	8.0	4.0	125	1
4	33	E/2010	T419E336(1)004(2)(3)(4)	CWR19C(3)336(1)(2)E(5)	2.0	8.0	3.0	125	1
4	47	E/2010	T419E476(1)004(2)(3)(4)	CWR19C(3)476(1)(2)E(5)	2.0	8.0	3.0	125	1
4	68	E/2010	T419E686(1)004(2)(3)(4)	CWR19C(3)686(1)(2)E(5)	3.0	8.0	3.0	125	1
4	100	F/2214	T419F107(1)004(2)(3)(4)	CWR19C(3)107(1)(2)F(5)	4.0	10.0	2.0	125	1
4	150	G/2711	T419G157(1)004(2)(3)(4)	CWR19C(3)157(1)(2)G(5)	6.0	10.0	1.0	125	1
4	220	H/2915	T419H227(1)004(2)(3)(4)	CWR19C(3)227(1)(2)H(5)	8.0	10.0	1.0	125	1
4	330	H/2915	T419H337(1)004(2)(3)(4)	CWR19C(3)337(1)(2)H(5)	10.0	10.0	0.9	125	1
6	3.3	A/1005	T419A335(1)006(2)(3)(4)	CWR19D(3)335(1)(2)A(5)	1.0	6.0	12.0	125	1
6	4.7	A/1005	T419A475(1)006(2)(3)(4)	CWR19D(3)475(1)(2)A(5)	1.0	6.0	12.0	125	1
6	6.8	B/1505	T419B685(1)006(2)(3)(4)	CWR19D(3)685(1)(2)B(5)	1.0	6.0	8.0	125	1
6	10	B/1505	T419B106(1)006(2)(3)(4)	CWR19D(3)106(1)(2)B(5)	1.0	6.0	8.0	125	1
6	15	B/1505	T419B156(1)006(2)(3)(4)	CWR19D(3)156(1)(2)B(5)	1.0	8.0	8.0	125	1
6	15	D/1510	T419D156(1)006(2)(3)(4)	CWR19D(3)156(1)(2)D(5)	1.0	8.0	5.0	125	1
6	15	E/2010	T419E156(1)006(2)(3)(4)	CWR19D(3)156(1)(2)E(5)	1.0	8.0	3.0	125	1
6	22	D/1510	T419D226(1)006(2)(3)(4)	CWR19D(3)226(1)(2)D(5)	1.0	6.0	5.0	125	1
6	22	E/2010	T419E226(1)006(2)(3)(4)	CWR19D(3)226(1)(2)E(5)	2.0	8.0	3.5	125	1
6	33	E/2010	T419E336(1)006(2)(3)(4)	CWR19D(3)336(1)(2)E(5)	2.0	6.0	3.5	125	1
6	47	F/2214	T419F476(1)006(2)(3)(4)	CWR19D(3)476(1)(2)F(5)	3.0	8.0	3.5	125	1
6	68	F/2214	T419F686(1)006(2)(3)(4)	CWR19D(3)686(1)(2)F(5)	4.0	10.0	1.5	125	1
6	68	G/2711	T419G686(1)006(2)(3)(4)	CWR19D(3)686(1)(2)G(5)	4.0	10.0	1.0	125	1
6	100	G/2711	T419G107(1)006(2)(3)(4)	CWR19D(3)107(1)(2)G(5)	6.0	10.0	1.1	125	1
6	150	G/2711	T419G157(1)006(2)(3)(4)	CWR19D(3)157(1)(2)G(5)	10.0	10.0	1.1	125	1
6	220	H/2915	T419H227(1)006(2)(3)(4)	CWR19D(3)227(1)(2)H(5)	10.0	10.0	0.9	125	1
6	330	H/2915	T419H337(1)006(2)(3)(4)	CWR19D(3)337(1)(2)H(5)	20.0	10.0	0.9	125	1
10	2.2	A/1005	T419A225(1)010(2)(3)(4)	CWR19F(3)225(1)(2)A(5)	1.0	6.0	12.0	125	1
10	3.3	A/1005	T419A335(1)010(2)(3)(4)	CWR19F(3)335(1)(2)A(5)	1.0	6.0	12.0	125	1
10	4.7	B/1505	T419B475(1)010(2)(3)(4)	CWR19F(3)475(1)(2)B(5)	1.0	6.0	8.0	125	1
10	4.7	C/2005	T419C475(1)010(2)(3)(4)	CWR19F(3)475(1)(2)C(5)	1.0	6.0	5.5	125	1
10	6.8	B/1505	T419B685(1)010(2)(3)(4)	CWR19F(3)685(1)(2)B(5)	1.0	6.0	8.0	125	1
10	6.8	C/2005	T419C685(1)010(2)(3)(4)	CWR19F(3)685(1)(2)C(5)	1.0	6.0	5.5	125	1
10	6.8	D/1510	T419D685(1)010(2)(3)(4)	CWR19F(3)685(1)(2)D(5)	1.0	6.0	5.0	125	1
10	10	B/1505	T419B106(1)010(2)(3)(4)	CWR19F(3)106(1)(2)B(5)	1.0	8.0	8.0	125	1
10	10	C/2005	T419C106(1)010(2)(3)(4)	CWR19F(3)106(1)(2)C(5)	1.0	6.0	5.5	125	1
10	10	D/1510	T419D106(1)010(2)(3)(4)	CWR19F(3)106(1)(2)D(5)	1.0	6.0	4.0	125	1
10	10	E/2010	T419E106(1)010(2)(3)(4)	CWR19F(3)106(1)(2)E(5)	1.0	6.0	3.5	125	1
10	15	D/1510	T419D156(1)010(2)(3)(4)	CWR19F(3)156(1)(2)D(5)	2.0	6.0	5.0	125	1
10	15	E/2010	T419E156(1)010(2)(3)(4)	CWR19F(3)156(1)(2)E(5)	2.0	8.0	3.0	125	1
10	22	E/2010	T419E226(1)010(2)(3)(4)	CWR19F(3)226(1)(2)E(5)	3.0	8.0	2.0	125	1
10	33	F/2214	T419F336(1)010(2)(3)(4)	CWR19F(3)336(1)(2)F(5)	3.0	8.0	1.5	125	1
VDC @ 85°C	µF	KEMET/EIA	(See below for part options)	(See below for part options)	µA @ +20°C Max/5 Min	% @ 20°C 120 Hz Max	Ω @ +20°C 100 kHz Max	°C	Reflow Temp ≤ 260°C
Rated Voltage	Rated Cap	Case Code/ Case Size	KEMET Part Number	MIL-PRF-55365/11 Part Number	DC Leakage	DF	ESR	Maximum Operating Temp	MSL

- (1) To complete KEMET/CWR part number, insert M for ±20%, K for ±10%, or J for ±5%. Designates Capacitance Tolerance.
 - (2) To complete KEMET/CWR part number, insert failure rate letter per the Ordering Information found on page 2. Designates Reliability Level.
 - (3) To complete KEMET/CWR part number, insert B = Gold-plated, C = Hot solder dipped, H = Solder plated or K = Solder fused. Designates Termination Finish.
 - (4) To complete KEMET part number, insert 4250 = +25°C after Weibull, 4251 = -55°C +85°C after Weibull, or 4252 = -55°C +85°C before Weibull. Designates Surge Current Option.
 - (5) To complete CWR part number, insert A = +25°C after Weibull, B = -55°C +85°C after Weibull, C = -55°C +85°C before Weibull or Z = None. Designates Surge Current Option.
- Refer to Ordering Information for additional detail.

Table 1 – Ratings & Part Number Reference cont.

Rated Voltage	Rated Cap	Case Code/ Case Size	KEMET Part Number	MIL-PRF-55365/11 Part Number	DC Leakage	DF	ESR	Maximum Operating Temp	MSL
VDC at 85°C	µF	KEMET/EIA	(See below for part options)	(See below for part options)	µA at +25°C Max/5 Min	% at 25°C 120 Hz Max	Ω at +25°C 100 kHz Max	°C	Reflow Temp ≤ 260°C
10	47	F/2214	T419F476(1)010(2)(3)(4)	CWR19F(3)476(1)(2)F(5)	4.0	10.0	1.5	125	1
10	47	G/2711	T419G476(1)010(2)(3)(4)	CWR19F(3)476(1)(2)G(5)	4.0	10.0	1.0	125	1
10	68	G/2711	T419G686(1)010(2)(3)(4)	CWR19F(3)686(1)(2)G(5)	6.0	10.0	1.1	125	1
10	100	G/2711	T419G107(1)010(2)(3)(4)	CWR19F(3)107(1)(2)G(5)	10.0	10.0	1.1	125	1
10	100	H/2915	T419H107(1)010(2)(3)(4)	CWR19F(3)107(1)(2)H(5)	10.0	10.0	0.9	125	1
10	150	H/2915	T419H157(1)010(2)(3)(4)	CWR19F(3)157(1)(2)H(5)	15.0	10.0	0.9	125	1
10	150	X/2824	T419X157(1)010(2)(3)(4)	CWR19F(3)157(1)(2)X(5)	15.0	10.0	0.9	125	1
10	220	H/2915	T419H227(1)010(2)(3)(4)	CWR19F(3)227(1)(2)H(5)	20.0	10.0	0.9	125	1
15	1	A/1005	T419A105(1)015(2)(3)(4)	CWR19H(3)105(1)(2)A(5)	1.0	6.0	15.0	125	1
15	1.5	A/1005	T419A155(1)015(2)(3)(4)	CWR19H(3)155(1)(2)A(5)	1.0	6.0	15.0	125	1
15	2.2	A/1005	T419A225(1)015(2)(3)(4)	CWR19H(3)225(1)(2)A(5)	1.0	6.0	15.0	125	1
15	3.3	B/1505	T419B335(1)015(2)(3)(4)	CWR19H(3)335(1)(2)B(5)	1.0	6.0	9.0	125	1
15	4.7	B/1505	T419B475(1)015(2)(3)(4)	CWR19H(3)475(1)(2)B(5)	1.0	6.0	5.0	125	1
15	4.7	C/2005	T419C475(1)015(2)(3)(4)	CWR19H(3)475(1)(2)C(5)	1.0	6.0	5.5	125	1
15	4.7	D/1510	T419D475(1)015(2)(3)(4)	CWR19H(3)475(1)(2)D(5)	1.0	6.0	6.0	125	1
15	6.8	D/1510	T419D685(1)015(2)(3)(4)	CWR19H(3)685(1)(2)D(5)	1.0	6.0	6.0	125	1
15	6.8	E/2010	T419E685(1)015(2)(3)(4)	CWR19H(3)685(1)(2)E(5)	1.0	8.0	3.0	125	1
15	10	D/1510	T419D106(1)015(2)(3)(4)	CWR19H(3)106(1)(2)D(5)	2.0	6.0	6.0	125	1
15	10	E/2010	T419E106(1)015(2)(3)(4)	CWR19H(3)106(1)(2)E(5)	2.0	6.0	4.0	125	1
15	15	E/2010	T419E156(1)015(2)(3)(4)	CWR19H(3)156(1)(2)E(5)	2.0	6.0	4.0	125	1
15	15	F/2214	T419F156(1)015(2)(3)(4)	CWR19H(3)156(1)(2)F(5)	2.0	8.0	3.0	125	1
15	22	F/2214	T419F226(1)015(2)(3)(4)	CWR19H(3)226(1)(2)F(5)	3.0	8.0	3.0	125	1
15	33	F/2214	T419F336(1)015(2)(3)(4)	CWR19H(3)336(1)(2)F(5)	5.0	6.0	3.0	125	1
15	33	G/2711	T419G336(1)015(2)(3)(4)	CWR19H(3)336(1)(2)G(5)	6.0	8.0	1.1	125	1
15	47	G/2711	T419G476(1)015(2)(3)(4)	CWR19H(3)476(1)(2)G(5)	10.0	8.0	1.1	125	1
15	47	H/2915	T419H476(1)015(2)(3)(4)	CWR19H(3)476(1)(2)H(5)	10.0	8.0	0.9	125	1
15	68	G/2711	T419G686(1)015(2)(3)(4)	CWR19H(3)686(1)(2)G(5)	10.0	8.0	1.1	125	1
15	68	H/2915	T419H686(1)015(2)(3)(4)	CWR19H(3)686(1)(2)H(5)	10.0	8.0	0.9	125	1
15	100	H/2915	T419H107(1)015(2)(3)(4)	CWR19H(3)107(1)(2)H(5)	15.0	10.0	0.9	125	1
20	0.68	A/1005	T419A684(1)020(2)(3)(4)	CWR19J(3)684(1)(2)A(5)	1.0	6.0	15.0	125	1
20	1	A/1005	T419A105(1)020(2)(3)(4)	CWR19J(3)105(1)(2)A(5)	1.0	6.0	15.0	125	1
20	1.5	B/1505	T419B155(1)020(2)(3)(4)	CWR19J(3)155(1)(2)B(5)	1.0	6.0	9.0	125	1
20	2.2	B/1505	T419B225(1)020(2)(3)(4)	CWR19J(3)225(1)(2)B(5)	1.0	6.0	9.0	125	1
20	3.3	D/1510	T419D335(1)020(2)(3)(4)	CWR19J(3)335(1)(2)D(5)	1.0	6.0	6.0	125	1
20	4.7	E/2010	T419E475(1)020(2)(3)(4)	CWR19J(3)475(1)(2)E(5)	1.0	6.0	6.0	125	1
20	6.8	E/2010	T419E685(1)020(2)(3)(4)	CWR19J(3)685(1)(2)E(5)	2.0	6.0	5.0	125	1
20	10	E/2010	T419E106(1)020(2)(3)(4)	CWR19J(3)106(1)(2)E(5)	2.0	6.0	5.0	125	1
20	10	F/2214	T419F106(1)020(2)(3)(4)	CWR19J(3)106(1)(2)F(5)	2.0	6.0	3.0	125	1
20	15	F/2214	T419F156(1)020(2)(3)(4)	CWR19J(3)156(1)(2)F(5)	3.0	6.0	3.0	125	1
20	22	G/2711	T419G226(1)020(2)(3)(4)	CWR19J(3)226(1)(2)G(5)	4.0	6.0	2.5	125	1
20	33	H/2915	T419H336(1)020(2)(3)(4)	CWR19J(3)336(1)(2)H(5)	6.0	8.0	0.9	125	1
20	47	H/2915	T419H476(1)020(2)(3)(4)	CWR19J(3)476(1)(2)H(5)	10.0	8.0	0.9	125	1
20	47	X/2824	T419X476(1)020(2)(3)(4)	CWR19J(3)476(1)(2)X(5)	10.0	8.0	0.9	125	1
25	0.47	A/1005	T419A474(1)025(2)(3)(4)	CWR19K(3)474(1)(2)A(5)	1.0	6.0	15.0	125	1
25	1	B/1505	T419B105(1)025(2)(3)(4)	CWR19K(3)105(1)(2)B(5)	1.0	6.0	10.0	125	1
25	2.2	D/1510	T419D225(1)025(2)(3)(4)	CWR19K(3)225(1)(2)D(5)	1.0	6.0	6.0	125	1
25	3.3	E/2010	T419E335(1)025(2)(3)(4)	CWR19K(3)335(1)(2)E(5)	1.0	6.0	4.0	125	1
VDC @ 85°C	µF	KEMET/EIA	(See below for part options)	(See below for part options)	µA @ +20°C Max/5 Min	% @ 20°C 120 Hz Max	Ω @ +20°C 100 kHz Max	°C	Reflow Temp ≤ 260°C
Rated Voltage	Rated Cap	Case Code/ Case Size	KEMET Part Number	MIL-PRF-55365/11 Part Number	DC Leakage	DF	ESR	Maximum Operating Temp	MSL

- (1) To complete KEMET/CWR part number, insert M for ±20%, K for ±10%, or J for ±5%. Designates Capacitance Tolerance.
 - (2) To complete KEMET/CWR part number, insert failure rate letter per the Ordering Information found on page 2. Designates Reliability Level.
 - (3) To complete KEMET/CWR part number, insert B = Gold-plated, C = Hot solder dipped, H = Solder plated or K = Solder fused. Designates Termination Finish.
 - (4) To complete KEMET part number, insert 4250 = +25°C after Weibull, 4251 = -55°C +85°C after Weibull, or 4252 = -55°C +85°C before Weibull. Designates Surge Current Option.
 - (5) To complete CWR part number, insert A = +25°C after Weibull, B = -55°C +85°C after Weibull, C = -55°C +85°C before Weibull or Z = None. Designates Surge Current Option.
- Refer to Ordering Information for additional detail.

Table 1 – Ratings & Part Number Reference cont.

Rated Voltage	Rated Cap	Case Code/ Case Size	KEMET Part Number	MIL-PRF-55365/11 Part Number	DC Leakage	DF	ESR	Maximum Operating Temp	MSL
VDC at 85°C	µF	KEMET/EIA	(See below for part options)	(See below for part options)	µA at +25°C Max/5 Min	% at 25°C 120 Hz Max	Ω at +25°C 100 kHz Max	°C	Reflow Temp ≤ 260°C
25	6.8	F/2214	T419F685(1)025(2)(3)(4)	CWR19K(3)685(1)(2)F(5)	2.0	6.0	3.0	125	1
25	15	G/2711	T419G156(1)025(2)(3)(4)	CWR19K(3)156(1)(2)G(5)	4.0	6.0	1.4	125	1
25	22	G/2711	T419G226(1)025(2)(3)(4)	CWR19K(3)226(1)(2)G(5)	6.0	6.0	1.4	125	1
25	22	H/2915	T419H226(1)025(2)(3)(4)	CWR19K(3)226(1)(2)H(5)	6.0	6.0	0.9	125	1
25	22	X/2824	T419X226(1)025(2)(3)(4)	CWR19K(3)226(1)(2)X(5)	6.0	6.0	0.9	125	1
25	33	H/2915	T419H336(1)025(2)(3)(4)	CWR19K(3)336(1)(2)H(5)	10.0	8.0	0.9	125	1
25	33	X/2824	T419X336(1)025(2)(3)(4)	CWR19K(3)336(1)(2)X(5)	10.0	8.0	0.9	125	1
35	0.33	A/1005	T419A334(1)035(2)(3)(4)	CWR19M(3)334(1)(2)A(5)	1.0	6.0	22.0	125	1
35	6.8	G/2711	T419G685(1)035(2)(3)(4)	CWR19M(3)685(1)(2)G(5)	3.0	6.0	1.5	125	1
35	10	H/2915	T419H106(1)035(2)(3)(4)	CWR19M(3)106(1)(2)H(5)	4.0	8.0	0.9	125	1
35	15	X/2824	T419X156(1)035(2)(3)(4)	CWR19M(3)156(1)(2)X(5)	6.0	6.0	0.9	125	1
VDC @ 85°C	µF	KEMET/EIA	(See below for part options)	(See below for part options)	µA @ +20°C Max/5 Min	% @ 20°C 120 Hz Max	Ω @ +20°C 100 kHz Max	°C	Reflow Temp ≤ 260°C
Rated Voltage	Rated Cap	Case Code/ Case Size	KEMET Part Number	MIL-PRF-55365/11 Part Number	DC Leakage	DF	ESR	Maximum Operating Temp	MSL

- (1) To complete KEMET/CWR part number, insert M for ±20%, K for ±10%, or J for ±5%. Designates Capacitance Tolerance.
(2) To complete KEMET/CWR part number, insert failure rate letter per the Ordering Information found on page 2. Designates Reliability Level.
(3) To complete KEMET/CWR part number, insert B = Gold-plated, C = Hot solder dipped, H = Solder plated or K = Solder fused. Designates Termination Finish.
(4) To complete KEMET part number, insert 4250 = +25°C after Weibull, 4251 = -55°C +85°C after Weibull, or 4252 = -55°C +85°C before Weibull. Designates Surge Current Option.
(5) To complete CWR part number, insert A = +25°C after Weibull, B = -55°C +85°C after Weibull, C = -55°C +85°C before Weibull or Z = None. Designates Surge Current Option.
Refer to Ordering Information for additional detail.

Recommended Voltage Derating Guidelines

	-55°C to 85°C	85°C to 125°C
% Change in Working DC Voltage with Temperature	V_R	67% of V_R
Recommended Maximum Application Voltage	50% of V_R	33% of V_R

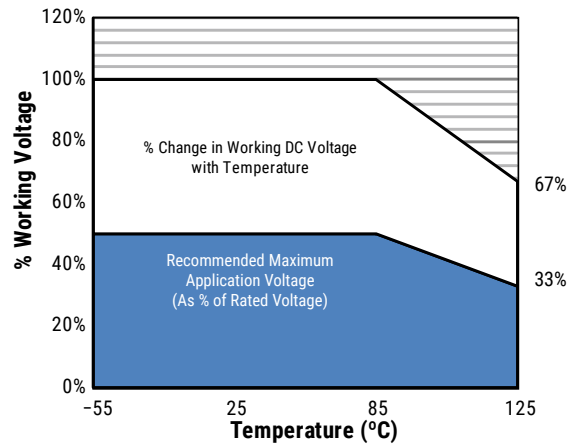

Ripple Current/Ripple Voltage

Permissible AC ripple voltage and current are related to equivalent series resistance (ESR) and the power dissipation capabilities of the device. Permissible AC ripple voltage which may be applied is limited by two criteria:

1. The positive peak AC voltage plus the DC bias voltage, if any, must not exceed the DC voltage rating of the capacitor.
2. The negative peak AC voltage in combination with bias voltage, if any, must not exceed the allowable limits specified for the reverse voltage. See the Reverse Voltage section for allowable limits.

The maximum power dissipation by case size can be determined using the table at right. The maximum power dissipation rating stated in the table must be reduced with increasing environmental operating temperatures. Refer to the table below for temperature compensation requirements.

Temperature Compensation Multipliers for Maximum Ripple Current		
$T \leq 25^\circ\text{C}$	$T \leq 85^\circ\text{C}$	$T \leq 125^\circ\text{C}$
1.00	0.90	0.40

T = Environmental Temperature

The maximum power dissipation rating must be reduced with increasing environmental operating temperatures. Refer to the Temperature Compensation Multiplier table for details.

Case Code	EIA Case Code	Maximum Power Dissipation (P max) mWatts at 25°C w/+20°C Rise
A	2513	50
B	3813	70
C	5113	75
D	3825	80
E	5125	90
F	5634	100
G	6728	125
H	7238	150
X	6954	165

Using the P max of the device, the maximum allowable rms ripple current or voltage may be determined.

$$I(\text{max}) = \sqrt{P \text{ max}/R}$$

$$E(\text{max}) = Z \sqrt{P \text{ max}/R}$$

I = rms ripple current (amperes)

E = rms ripple voltage (volts)

$P \text{ max}$ = maximum power dissipation (watts)

R = ESR at specified frequency (ohms)

Z = Impedance at specified frequency (ohms)

Reverse Voltage

Solid tantalum capacitors are polar devices and may be permanently damaged or destroyed if connected with the wrong polarity. The positive terminal is identified on the capacitor body by a stripe, plus, in some cases a beveled edge. A small degree of transient reverse voltage is permissible for short periods per the table. The capacitors should not be operated continuously in reverse mode, even within these limits.

Temperature	Permissible Transient Reverse Voltage
25°C	15% of Rated Voltage
85°C	5% of Rated Voltage
125°C	1% of Rated Voltage

Table 2 – Land Dimensions/Courtyard

KEMET	Metric Size Code	Density Level A: Maximum (Most) Land Protrusion (mm)					Density Level B: Median (Nominal) Land Protrusion (mm)					Density Level C: Minimum (Least) Land Protrusion (mm)						
		Case	EIA	L	W	S	V1	V2	L	W	S	V1	V2	L	W	S	V1	V2
		A ¹	1005	2.19	1.44	0.15	5.54	2.66	1.89	1.32	0.15	4.44	2.16	1.52	1.22	0.29	3.58	1.90
		B	1505	2.30	1.44	1.20	6.80	2.66	1.90	1.32	1.40	5.70	2.16	1.52	1.22	1.56	4.84	1.90
		C	2005	2.30	1.44	2.47	8.08	2.66	1.90	1.32	2.67	6.98	2.16	1.52	1.22	2.83	6.12	1.90
		D	1510	2.30	2.58	1.20	6.80	3.92	1.90	2.46	1.40	5.70	3.42	1.52	2.36	1.56	4.84	3.16
		E	2010	2.30	2.58	2.47	8.08	3.92	1.90	2.46	2.67	6.98	3.42	1.52	2.36	2.83	6.12	3.16
		F	2214	2.30	3.47	2.98	8.58	4.82	1.90	3.35	3.18	7.48	4.32	1.52	3.25	3.34	6.62	4.06
		G	2711	2.81	2.84	3.10	9.72	4.18	2.41	2.72	3.30	8.62	3.68	2.03	2.62	3.46	7.76	3.42
		H	2915	2.81	3.84	3.61	10.24	5.20	2.41	3.72	3.81	9.14	4.70	2.03	3.62	3.97	8.28	4.44
		X	2824	2.73	3.22	3.46	9.92	6.80	2.33	3.10	3.66	8.82	6.30	1.95	3.00	3.82	7.96	6.04

Density Level A: For low-density product applications. Recommended for wave solder applications and provides a wider process window for reflow solder processes.

Density Level B: For products with a moderate level of component density. Provides a robust solder attachment condition for reflow solder processes.

Density Level C: For high component density product applications. Before adapting the minimum land pattern variations, the user should perform qualification testing based on the conditions outlined in IPC standard 7351 (IPC-7351).

¹ Land pattern geometry is too small for silkscreen outline.

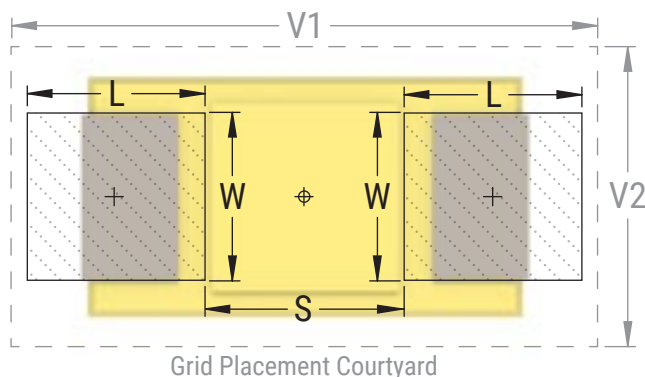

Soldering Process

KEMET’s families of surface mount capacitors are compatible with wave (single or dual), convection, IR, or vapor phase reflow techniques. Preheating of these components is recommended to avoid extreme thermal stress. KEMET’s recommended profile conditions for convection and IR reflow reflect the profile conditions of the IPC/J–STD–020D standard for moisture sensitivity testing. The devices can safely withstand a maximum of three reflow passes at these conditions.

Please note that although the X/7343–43 case size can withstand wave soldering, the tall profile (4.3 mm maximum) dictates care in wave process development.

Hand soldering should be performed with care due to the difficulty in process control. If performed, care should be taken to avoid contact of the soldering iron to the molded case. The iron should be used to heat the solder pad, applying solder between the pad and the termination, until reflow occurs. Once reflow occurs, the iron should be removed immediately. “Wiping” the edges of a chip and heating the top surface is not recommended.

During typical reflow operations, a slight darkening of the gold-colored epoxy may be observed. This slight darkening is normal and not harmful to the product. Marking permanency is not affected by this change.

Profile Feature	SnPb Assembly	Pb-Free Assembly
Preheat/Soak		
Temperature Minimum (T_{smin})	100°C	150°C
Temperature Maximum (T_{smax})	150°C	200°C
Time (t_s) from T_{smin} to T_{smax}	60 – 120 seconds	60 – 120 seconds
Ramp-up Rate (T_L to T_p)	3°C/second maximum	3°C/second maximum
Liquidous Temperature (T_L)	183°C	217°C
Time Above Liquidous (t_L)	60 – 150 seconds	60 – 150 seconds
Peak Temperature (T_p)	220°C* 235°C**	250°C* 260°C**
Time within 5°C of Maximum Peak Temperature (t_p)	20 seconds maximum	30 seconds maximum
Ramp-down Rate (T_p to T_L)	6°C/second maximum	6°C/second maximum
Time 25°C to Peak Temperature	6 minutes maximum	8 minutes maximum

Note: All temperatures refer to the center of the package, measured on the package body surface that is facing up during assembly reflow.

* For Case Size height > 2.5 mm

** For Case Size height ≤ 2.5 mm

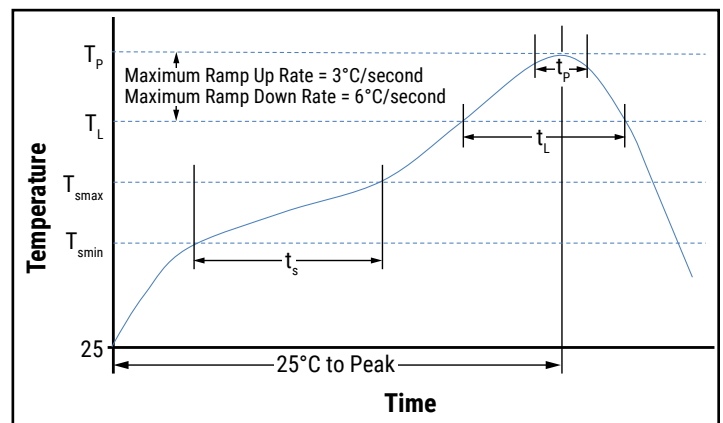

Storage

Tantalum chip capacitors should be stored in normal working environments. While the chips themselves are quite robust in other environments, solderability will be degraded by exposure to high temperatures, high humidity, corrosive atmospheres, and long term storage. In addition, packaging materials will be degraded by high temperature – reels may soften or warp and tape peel force may increase. KEMET recommends that maximum storage temperature not exceed 40°C and maximum storage humidity not exceed 60% relative humidity. Temperature fluctuations should be minimized to avoid condensation on the parts and atmospheres should be free of chlorine and sulphur bearing compounds. For optimized solderability chip stock should be used promptly, preferably within three years of receipt.

Construction

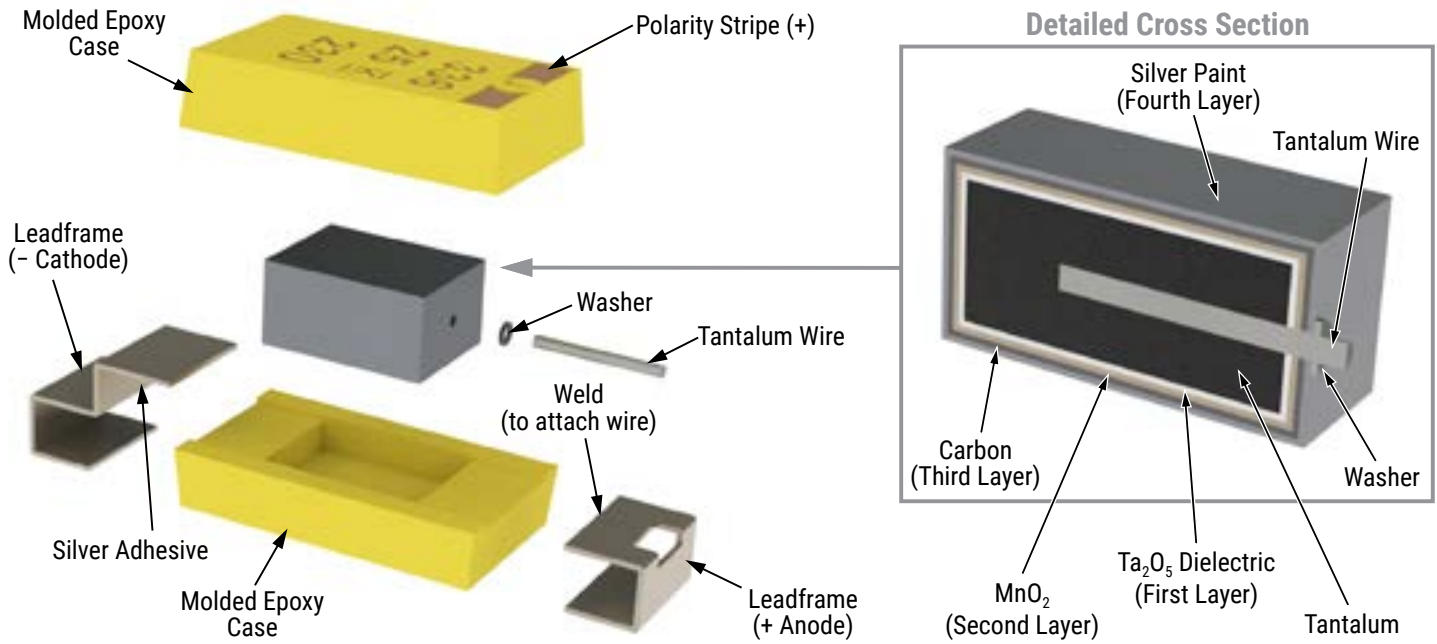

Capacitor Marking

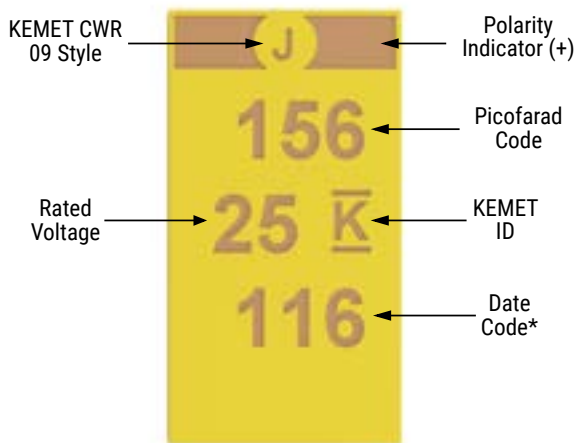

* 116 = 16th week of 2021

Date Code *	
1 st digit = last number of year	7 = 2017 8 = 2018 9 = 2019 0 = 2020 1 = 2021 2 = 2022
2 nd and 3 rd digit = week of the year	01 = 1 st week of the year to 52 = 52 nd week of the year

Tape & Reel Packaging Information

KEMET’s molded tantalum and aluminum chip capacitor families are packaged in 8 and 12 mm plastic tape on 7” and 13” reels in accordance with *EIA Standard 481: Embossed Carrier Taping of Surface Mount Components for Automatic Handling*. This packaging system is compatible with all tape-fed automatic pick-and-place systems.



Table 3 – Packaging Quantity

KEMET Case Codes		Tape Width (mm)	Tape and Reel Dimensions	
			180 mm (7" diameter)	330 mm (13" diameter)
A	1005	8	2,500	9,500
B	1505	12	2,500	9,500
C	2005	12	2,500	9,500
D	1510	12	2,500	9,500
E	2010	12	2,500	9,500
F	2214	12	500	3,500
G	2711	12	500	2,500
H	2915	12	500	2,500
X	2824	12	500	2,500

Figure 1 – Embossed (Plastic) Carrier Tape Dimensions



Table 4 – Embossed (Plastic) Carrier Tape Dimensions

Metric will govern

Constant Dimensions – Millimeters (Inches)									
Tape Size	D ₀	D ₁ Minimum Note 1	E ₁	P ₀	P ₂	R Reference Note 2	S ₁ Minimum Note 3	T Maximum	T ₁ Maximum
8 mm	1.5 +0.10/-0.0 (0.059 +0.004/-0.0)	1.0 (0.039)	1.75 ±0.10 (0.069 ±0.004)	4.0 ±0.10 (0.157 ±0.004)	2.0 ±0.05 (0.079 ±0.002)	25.0 (0.984)	0.600 (0.024)	0.600 (0.024)	0.100 (0.004)
12 mm		1.5 (0.059)							

Variable Dimensions – Millimeters (Inches)									
Tape Size	Pitch	B ₁ Maximum Note 4	E ₂ Minimum	F	P ₁	T ₂ Maximum	W Maximum	A ₀ , B ₀ & K ₀	
8 mm	Single (4 mm)	4.35 (0.171)	6.25 (0.246)	3.5 ±0.05 (0.138 ±0.002)	2.0 ±0.05 or 4.0 ±0.10 (0.079 ±0.002 or 0.157 ±0.004)	2.5 (0.098)	8.3 (0.327)	Note 5	
12 mm	Single (4 mm) and Double (8 mm)	8.2 (0.323)	10.25 (0.404)	5.5 ±0.05 (0.217 ±0.002)	2.0 ±0.05 (0.079 ±0.002) or 4.0 ±0.10 (0.157 ±0.004) or 8.0 ±0.10 (0.315 ±0.004)	4.6 (0.181)	12.3 (0.484)		

- The embossment hole location shall be measured from the sprocket hole controlling the location of the embossment. Dimensions of embossment location and hole location shall be applied independent of each other.
- The tape, with or without components, shall pass around R without damage (see Figure 4).
- If S₁ < 1.0 mm, there may not be enough area for cover tape to be properly applied (see EIA Standard 481-D, paragraph 4.3, section b).
- B₁ dimension is a reference dimension for tape feeder clearance only.
- The cavity defined by A₀, B₀ and K₀ shall surround the component with sufficient clearance that:
 - the component does not protrude above the top surface of the carrier tape.
 - the component can be removed from the cavity in a vertical direction without mechanical restriction, after the top cover tape has been removed.
 - rotation of the component is limited to 20° maximum for 8 and 12 mm tapes (see Figure 2).
 - lateral movement of the component is restricted to 0.5 mm maximum for 8 mm and 12 mm wide tape (see Figure 3).
 - see Addendum in EIA Standard 481-D for standards relating to more precise taping requirements.

Packaging Information Performance Notes

- 1. Cover Tape Break Force:** 1.0 kg minimum.
- 2. Cover Tape Peel Strength:** The total peel strength of the cover tape from the carrier tape shall be:

Tape Width	Peel Strength
8 mm	0.1 to 1.0 Newton (10 to 100 gf)
12 and 16 mm	0.1 to 1.3 Newton (10 to 130 gf)

The direction of the pull shall be opposite the direction of the carrier tape travel. The pull angle of the carrier tape shall be 165° to 180° from the plane of the carrier tape. During peeling, the carrier and/or cover tape shall be pulled at a velocity of 300 ±10 mm/minute.

- 3. Labeling:** Bar code labeling (standard or custom) shall be on the side of the reel opposite the sprocket holes. Refer to EIA Standards 556 and 624.

Figure 2 – Maximum Component Rotation

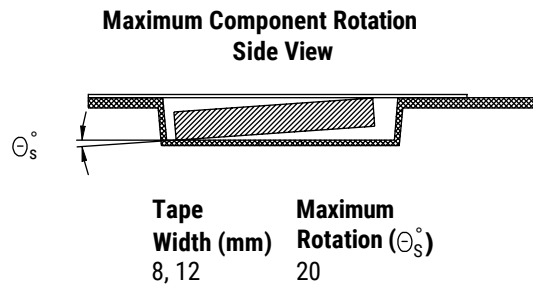
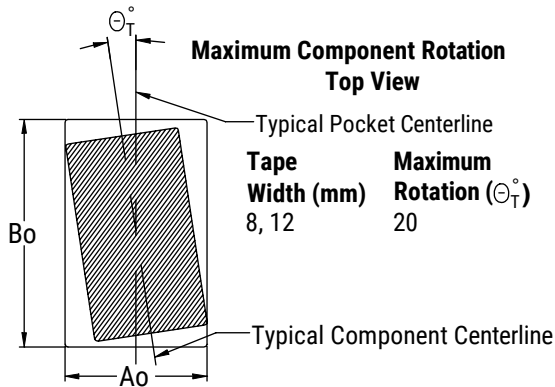

Figure 3 – Maximum Lateral Movement



Figure 4 – Bending Radius

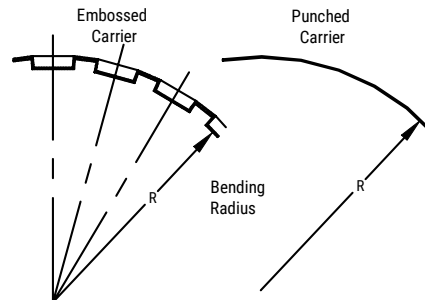

Figure 5 – Reel Dimensions



Note: Drive spokes optional; if used, dimensions B and D shall apply.

Table 5 – Reel Dimensions

Metric will govern

Constant Dimensions – Millimeters (Inches)				
Tape Size	A	B Minimum	C	D Minimum
8 mm	178 ±0.20 (7.008 ±0.008)	1.5 (0.059)	13.0 +0.5/-0.2 (0.521 +0.02/-0.008)	20.2 (0.795)
12 mm	330 ±0.20 (13.000 ±0.008)			
Variable Dimensions – Millimeters (Inches)				
Tape Size	N Minimum	W ₁	W ₂ Maximum	W ₃
8 mm	50 (1.969)	8.4 +1.5/-0.0 (0.331 +0.059/-0.0)	14.4 (0.567)	Shall accommodate tape width without interference
12 mm		12.4 +2.0/-0.0 (0.488 +0.078/-0.0)	18.4 (0.724)	

Figure 6 – Tape Leader & Trailer Dimensions

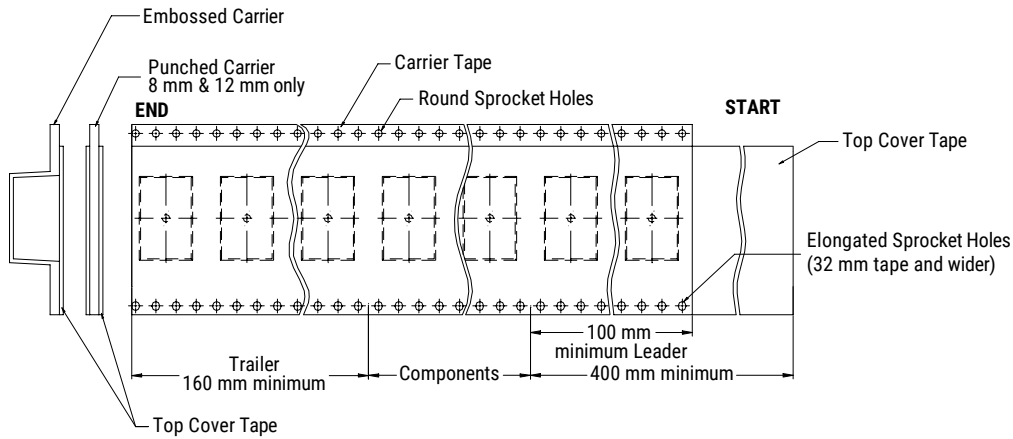
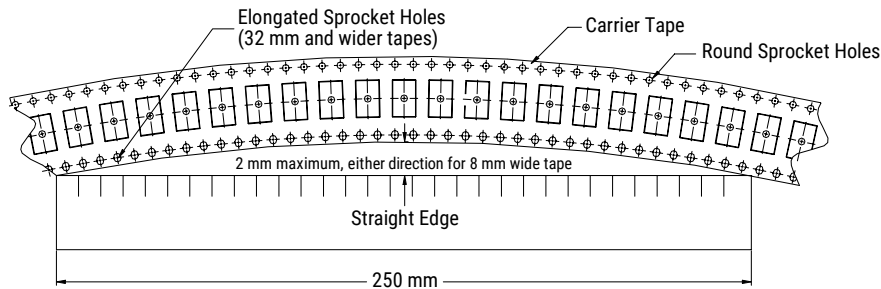

Figure 7 – Maximum Camber



KEMET Electronics Corporation Sales Offices

For a complete list of our global sales offices, please visit www.kemet.com/sales.

Disclaimer

All product specifications, statements, information and data (collectively, the "Information") in this datasheet are subject to change. The customer is responsible for checking and verifying the extent to which the Information contained in this publication is applicable to an order at the time the order is placed. All Information given herein is believed to be accurate and reliable, but it is presented without guarantee, warranty, or responsibility of any kind, expressed or implied.

Statements of suitability for certain applications are based on KEMET Electronics Corporation's ("KEMET") knowledge of typical operating conditions for such applications, but are not intended to constitute – and KEMET specifically disclaims – any warranty concerning suitability for a specific customer application or use. The Information is intended for use only by customers who have the requisite experience and capability to determine the correct products for their application. Any technical advice inferred from this Information or otherwise provided by KEMET with reference to the use of KEMET's products is given gratis, and KEMET assumes no obligation or liability for the advice given or results obtained.

Although KEMET designs and manufactures its products to the most stringent quality and safety standards, given the current state of the art, isolated component failures may still occur. Accordingly, customer applications which require a high degree of reliability or safety should employ suitable designs or other safeguards (such as installation of protective circuitry or redundancies) in order to ensure that the failure of an electrical component does not result in a risk of personal injury or property damage.

Although all product-related warnings, cautions and notes must be observed, the customer should not assume that all safety measures are indicated or that other measures may not be required.

KEMET is a registered trademark of KEMET Electronics Corporation.

单击下面可查看定价，库存，交付和生命周期等信息

[>>KEMET\(基美\)](#)