

PEH506, Aluminum Electrolytic, 220 uF, 20%, 400 VDC, -40/+85°C

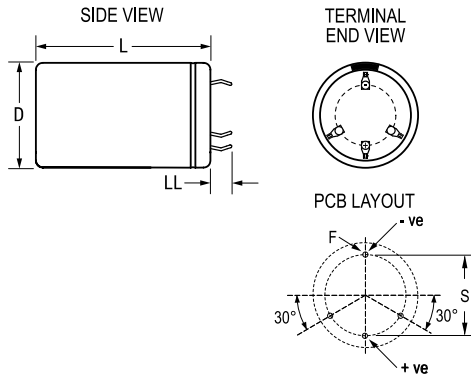

General Information	
Series:	PEH506
Dielectric:	Aluminum Electrolytic
Description:	Snap-In, Aluminum Electrolytic
RoHS:	Yes
Lead:	4 Pin
AEC-Q200:	No
Component Weight:	32 g
Notes:	Add 0.5mm To D And 1mm To L For Sleeving.
Shelf Life:	208 Weeks

Dimensions	
D	35mm +/-0.5mm
L	25mm +/-1mm
S	22.5mm NOM
LL	6.3mm +/-1mm
F	2mm +/-0.1mm

Specifications	
Capacitance:	220 uF
Capacitance Tolerance:	20%
Voltage DC:	400 VDC
Temperature Range:	-40/+85°C
Rated Temperature:	85°C
Life:	3000 Hrs (Rated Voltage And Ripple Current At 85C), 6000 Hrs (Rated Voltage At 85C)
Resistance:	550 mOhms (100Hz 20C), 350 mOhms (100kHz 20C)
Ripple Current:	1.4 Amps (100Hz 85C), 4.5 Amps (20kHz 40C)
Leakage Current:	264 uA (5min 20°C)

Packaging Specifications	
Packaging:	Bulk, Bag

Statements of suitability for certain applications are based on our knowledge of typical operating conditions for such applications, but are not intended to constitute - and we specifically disclaim - any warranty concerning suitability for a specific customer application or use. This Information is intended for use only by customers who have the requisite experience and capability to determine the correct products for their application. Any technical advice inferred from this Information or otherwise provided by us with reference to the use of our products is given gratis, and we assume no obligation or liability for the advice given or results obtained.

单击下面可查看定价，库存，交付和生命周期等信息

[>>KEMET\(基美\)](#)