

KEMET Part Number: PHE820MB5150KR17
(F720BD153K275A)

KEMET

a YAGEO company

PHE820M/F720, Film, Metallized Polyester, Safety, 0.015 uF, 10%, 275 VAC (X2), 760 VDC, 100°C, Lead Spacing = 15mm

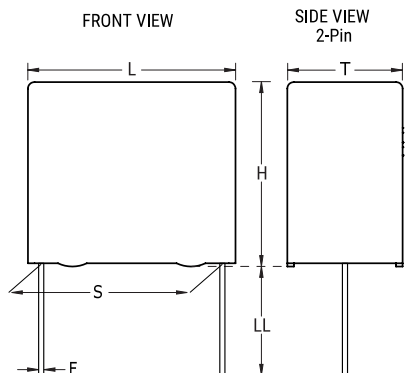

Dimensions

L	18mm MAX
H	10.5mm MAX
T	5.5mm MAX
S	15mm +/-0.4mm
LL	17mm -1mm
F	0.8mm NOM
G	0.5mm NOM

Packaging Specifications

Packaging:	Bulk, Bag
Packaging Quantity:	800

General Information

Series:	PHE820M/F720
Dielectric:	Metallized Polyester
Style:	Radial
Features:	EMI Safety
RoHS:	Yes
Lead:	Wire Leads
Safety Class:	X2
Qualifications:	ENEC, UL, cUL
AEC-Q200:	No
THB Performance:	No
Miscellaneous:	SRF= 11 MHz.
Notes:	Not For New Design, Please Check Possible Alternative Parts (AltPart).

Specifications

Capacitance:	0.015 uF
Capacitance Tolerance:	10%
Voltage AC:	275 VAC (X2)
Voltage DC:	760 VDC
Temperature Range:	-40/+100°C
Rated Temperature:	100°C
Dissipation Factor:	1% 1kHz
Insulation Resistance:	30 GOhms
Max dV/dt:	100 V/us

Statements of suitability for certain applications are based on our knowledge of typical operating conditions for such applications, but are not intended to constitute - and we specifically disclaim - any warranty concerning suitability for a specific customer application or use. This Information is intended for use only by customers who have the requisite experience and capability to determine the correct products for their application. Any technical advice inferred from this Information or otherwise provided by us with reference to the use of our products is given gratis, and we assume no obligation or liability for the advice given or results obtained.

KEMET

a YAGEO company

单击下面可查看定价，库存，交付和生命周期等信息

[>>KEMET\(基美\)](#)

[>>点击查看相关商品](#)