

T510, Tantalum, MnO2 Tantalum, Multi-Anode, 100 uF, 20%, 25 VDC, SMD, MnO2, Molded, Large Case, Multi-Anode, LowESR, 50 mOhms, 7360, Height Max = 3.8mm

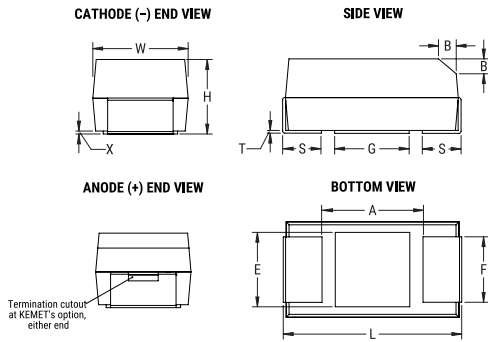

General Information	
Series:	T510
Dielectric:	MnO2 Tantalum
Style:	SMD Chip
Description:	SMD, MnO2, Molded, Large Case, Multi-Anode, LowESR
Features:	Low ESR
RoHS:	Yes
Termination:	Tin
AEC-Q200:	No
Component Weight:	500.73 mg
Shelf Life:	156 Weeks
MSL:	1

Dimensions	
Footprint	7360
L	7.3mm +/-0.3mm
W	6mm +/-0.3mm
H	3.6mm +/-0.2mm
T	0.13mm REF
S	1.3mm +/-0.3mm
F	4.1mm +/-0.1mm
A	3.8mm MIN
B	0.5mm +/-0.15mm
E	3.5mm REF
G	3.5mm REF
X	0.1mm +/-0.1mm

Specifications	
Capacitance:	100 uF
Capacitance Tolerance:	20%
Voltage DC:	25 VDC (85C), 16.75 VDC (125C)
Temperature Range:	-55/+125°C
Rated Temperature:	85°C
Dissipation Factor:	8% 120Hz 25C
Failure Rate:	N/A
Resistance:	50 mOhms (100kHz 25C)
Ripple Current:	2387 mA (rms, 100kHz 25C), 2148.3 mA (rms, 85C), 954.8 mA (rms, 125C)
Leakage Current:	25 uA (5min 25°C)

Packaging Specifications	
Packaging:	T&R, 178mm
Packaging Quantity:	500

Statements of suitability for certain applications are based on our knowledge of typical operating conditions for such applications, but are not intended to constitute - and we specifically disclaim - any warranty concerning suitability for a specific customer application or use. This Information is intended for use only by customers who have the requisite experience and capability to determine the correct products for their application. Any technical advice inferred from this Information or otherwise provided by us with reference to the use of our products is given gratis, and we assume no obligation or liability for the advice given or results obtained.

单击下面可查看定价，库存，交付和生命周期等信息

[>>KEMET\(基美\)](#)