

T493 Space, Tantalum, MnO2 Tantalum, Space, 220 uF, 10%, 10 VDC, SMD, MnO2, Molded, Aerospace, C (0.01%/1000 Hrs), 100 mOhms, 7343, Height Max = 4.3mm

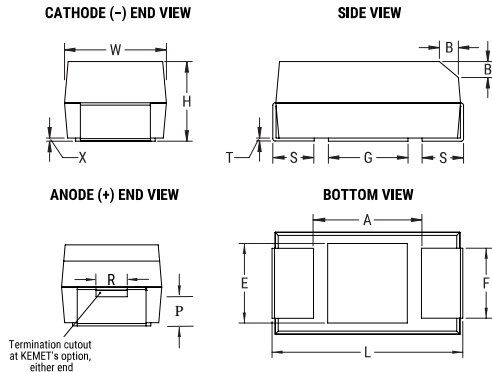

Dimensions	
Footprint	7343
L	7.3mm +/-0.3mm
W	4.3mm +/-0.3mm
H	4mm +/-0.3mm
T	0.13mm REF
S	1.3mm +/-0.3mm
F	2.4mm +/-0.1mm
A	3.8mm MIN
B	0.5mm +/-0.15mm
E	3.5mm REF
G	3.5mm REF
P	1.7mm REF
R	1mm REF
X	0.1mm +/-0.1mm

Packaging Specifications	
Packaging:	T&R, 178mm
Packaging Quantity:	500

General Information	
Series:	T493 Space
Dielectric:	MnO2 Tantalum
Style:	SMD Chip
Description:	SMD, MnO2, Molded, Aerospace
Features:	Aerospace
RoHS:	No
Prop 65:	WARNING: Cancer and reproductive harm - www.p65warnings.ca.gov
SCIP Number:	1dd2e1b8-26dd-4d52-927c-6f9d519011aa
Termination:	Solder Coated
AEC-Q200:	No
Component Weight:	654.04 mg

Specifications	
Capacitance:	220 uF
Capacitance Tolerance:	10%
Voltage DC:	10 VDC (85C), 6.7 VDC (125C)
Temperature Range:	-55/+125°C
Rated Temperature:	85°C
Dissipation Factor:	8% 120Hz 20C
Failure Rate:	C (0.01%/1000 Hrs)
Resistance:	0.1 Ohms (100kHz 20C)
Leakage Current:	22 uA (5min 20°C)
Testing and Reliability:	10 Cycles Surge Testing At -55C And +85C Before Weibull; Additional Testing Option C

Statements of suitability for certain applications are based on our knowledge of typical operating conditions for such applications, but are not intended to constitute - and we specifically disclaim - any warranty concerning suitability for a specific customer application or use. This Information is intended for use only by customers who have the requisite experience and capability to determine the correct products for their application. Any technical advice inferred from this Information or otherwise provided by us with reference to the use of our products is given gratis, and we assume no obligation or liability for the advice given or results obtained.

单击下面可查看定价，库存，交付和生命周期等信息

[>>KEMET\(基美\)](#)