

CAN SMD Indust 250, Ceramic, 1000 pF, 20%, X7R, SMD Chip, MLCC, AC Rated, 0603

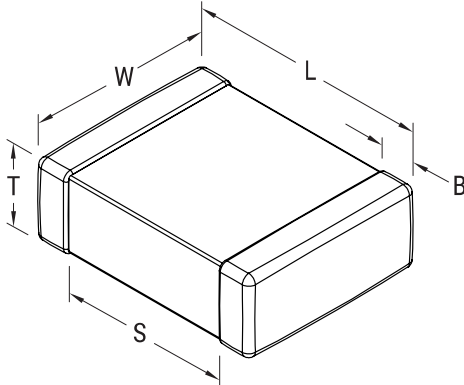

Dimensions

Chip Size	0603
L	1.6mm +/-0.17mm
W	0.8mm +/-0.15mm
T	0.8mm +/-0.10mm
S	0.58mm MIN
B	0.45mm +/-0.15mm

Packaging Specifications

Packaging:	Bulk, Bag
Packaging Quantity:	1

General Information

Series:	CAN SMD Indust 250
Style:	SMD Chip
Description:	SMD Chip, MLCC, AC Rated
Features:	Temperature Stable, Class II
RoHS:	Yes
Termination:	Flexible Termination
Marking:	No
AEC-Q200:	No
Miscellaneous:	Note: Referee time for X7R dielectric for this part number is 1000 hours.
MSL:	1

Specifications

Capacitance:	1000 pF
Measurement Condition:	1 kHz 1.0Vrms
Capacitance Tolerance:	20%
Voltage AC:	250 VAC
Dielectric Withstanding Voltage:	945 VDC
Temperature Range:	-55/+125°C
Temperature Coefficient:	X7R
Capacitance Change with Reference to +25°C and 0 VDC Applied (TCC):	15%, 1kHz 1.0Vrms
Dissipation Factor:	2.5% 1 kHz 1.0Vrms
Aging Rate:	3% Loss/Decade Hour
Insulation Resistance:	10 GOhms

单击下面可查看定价，库存，交付和生命周期等信息

[>>KEMET\(基美\)](#)