

ELX, Aluminum Electrolytic, 470 uF, 20%, 500 VDC, -25/+105°C

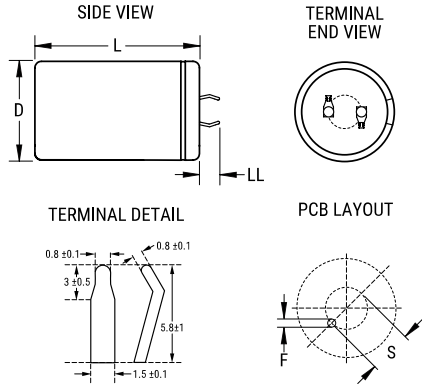

General Information	
Series:	ELX
Dielectric:	Aluminum Electrolytic
Description:	Snap-In, Aluminum Electrolytic
RoHS:	Yes
Lead:	2 Pin
AEC-Q200:	No

Dimensions	
D	35mm +1mm
L	60mm +2mm
S	10mm +/-0.5mm
LL	5.8mm +/-1mm
F	1.5mm +/-0.1mm

Specifications	
Capacitance:	470 uF
Capacitance Tolerance:	20%
Voltage DC:	500 VDC, 550 VDC (Surge)
Temperature Range:	-25/+105°C
Rated Temperature:	105°C
Life:	5000 Hrs
Dissipation Factor:	25% 120Hz 20C
Resistance:	0.705 Ohms (120Hz 20C)
Ripple Current:	2.03 Amps (120Hz 105C)
Leakage Current:	1525 mA (5min 20°C)

Packaging Specifications	
Packaging:	Bulk, Bag
Packaging Quantity:	200

Statements of suitability for certain applications are based on our knowledge of typical operating conditions for such applications, but are not intended to constitute - and we specifically disclaim - any warranty concerning suitability for a specific customer application or use. This Information is intended for use only by customers who have the requisite experience and capability to determine the correct products for their application. Any technical advice inferred from this Information or otherwise provided by us with reference to the use of our products is given gratis, and we assume no obligation or liability for the advice given or results obtained.

单击下面可查看定价，库存，交付和生命周期等信息

[>>KEMET\(基美\)](#)