

C4BT, Film, Metallized Polypropylene, Power, 2.5 uF, 5%, 600 VDC, 70°C, Lead Spacing = 25.5mm

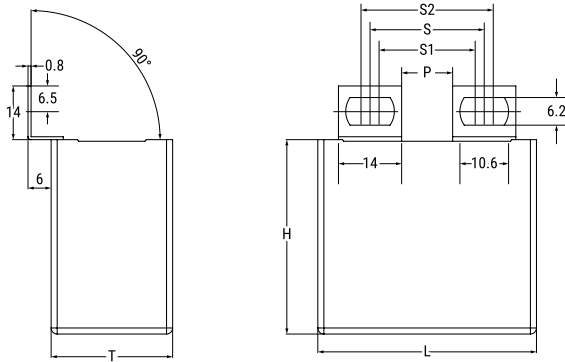

General Information	
Series:	C4BT
Dielectric:	Metallized Polypropylene
Style:	Radial
Features:	Switching
RoHS:	Yes
Lead:	Flat Tabs
AEC-Q200:	No
Miscellaneous:	KEMET Style A Tabs. Peak Voltage = 600 VDC.

Dimensions	
L	41.5mm +1.5/-0.7mm
H	40mm +0.2/-0.7mm
T	20mm +0.4/-0.7mm
S	25.5mm +/-0.2mm
S1	21.5mm +/-0.2mm
S2	29.5mm +/-0.2mm
P	10.5mm NOM

Specifications	
Capacitance:	2.5 uF
Capacitance Tolerance:	5%
Voltage DC:	600 VDC
Temperature Range:	-40/+85°C
Rated Temperature:	70°C
Max dV/dt:	70 V/us
Resistance:	5.7 mOhms (100kHz)
Ripple Current:	18 Amps (100kHz 70C), 176 Amps (Peak)
Inductance:	41 nH

Packaging Specifications	
Packaging:	Bulk, Bag
Packaging Quantity:	52

Statements of suitability for certain applications are based on our knowledge of typical operating conditions for such applications, but are not intended to constitute - and we specifically disclaim - any warranty concerning suitability for a specific customer application or use. This Information is intended for use only by customers who have the requisite experience and capability to determine the correct products for their application. Any technical advice inferred from this Information or otherwise provided by us with reference to the use of our products is given gratis, and we assume no obligation or liability for the advice given or results obtained.

单击下面可查看定价，库存，交付和生命周期等信息

[>>KEMET\(基美\)](#)